

Gryphon™ | GFS4100

Fixed Mount Linear Imager Bar Code Reader



Product Reference Guide

Datalogic Scanning, Inc.

959 Terry Street
Eugene, Oregon 97402
USA
Telephone: (541) 683-5700
Fax: (541) 345-7140

An Unpublished Work - All rights reserved. No part of the contents of this documentation or the procedures described therein may be reproduced or transmitted in any form or by any means without prior written permission of Datalogic Scanning, Inc. or its subsidiaries or affiliates ("Datalogic" or "Datalogic Scanning"). Owners of Datalogic products are hereby granted a non-exclusive, revocable license to reproduce and transmit this documentation for the purchaser's own internal business purposes. Purchaser shall not remove or alter any proprietary notices, including copyright notices, contained in this documentation and shall ensure that all notices appear on any reproductions of the documentation.

Should future revisions of this manual be published, you can acquire printed versions by contacting your Datalogic representative. Electronic versions may either be downloadable from the Datalogic website (www.scanning.datalogic.com) or provided on appropriate media. If you visit our website and would like to make comments or suggestions about this or other Datalogic publications, please let us know via the "Contact Datalogic" page.

Disclaimer

Datalogic has taken reasonable measures to provide information in this manual that is complete and accurate, however, Datalogic reserves the right to change any specification at any time without prior notice.

Datalogic and the Datalogic logo are registered trademarks of Datalogic S.p.A. in many countries, including the U.S.A and the E.U. All other brand and product names referred to herein may be trademarks of their respective owners.

Microsoft Windows®, Windows® XP and the Windows logo are registered trademarks of Microsoft Corporation.

Patents

This product is covered by one or more of the following patents.

US Pat.: 5,144,118; 5,311,000; 5,481,098; 5,493,108; 5,929,421; 5,992,740; 6,098,883; 6,260,764; 6,443,360 B1; 6,631,846 B2; 6,808,114 B1; 6,817,525 B2; 6,997,385 B2; 7,075,663 B2; 7,387,246 B2.

European Pat.: 789,315 B1; 926,620 B1; 962,880 B1; 997,760 B1; 1,128,315 B1; 1,164,536 B1; 1,217,571 B1; 1,396,811 B1; 1,413,971 B1.

Additional patents pending.

Table of Contents

INTRODUCTION	7
About this Manual	7
Overview	7
Manual Conventions	7
References	8
Technical Support	8
Datalogic Website Support	8
Reseller Technical Support	8
Telephone Technical Support	8
About the Reader	8
Programming the Reader	9
Configuration Methods	9
SETUP	11
Unpacking	11
Setting Up the Reader	11
Installing the Interface Cable	12
Interface Selection	13
Setting the Interface	13
Customizing Configuration Settings	15
Configure Interface Settings	15
Global Interface Features	15
Software Version Transmission	15
Resetting Product Configuration to Defaults	16
CONFIGURATION USING BARCODES	17
Configuration Parameters	17
Reading Configuration Barcodes	18
GLOBAL INTERFACE FEATURES 19	
Host Commands — Obey/Ignore	19
RS-232 ONLY Interface	21
Baud Rate	22
Data Bits	23
Stop Bits	23
Parity	24
Handshaking Control	25
RS-232/USB-Com Interfaces	26
Intercharacter Delay	27
Beep On ASCII BEL	27
Beep On Not on File	28
ACK NAK Options	28
ACK Character	29
NAK Character	29
ACK NAK Timeout Value	30
ACK NAK Retry Count	30
ACK NAK Error Handling	31
Indicate Transmission Failure	31
Disable Character	32
Enable Character	32
USB Keyboard Interfaces	33
Country Mode	34
Send Control Characters	37
USB Keyboard Speed	38
Data Format	41
Global Prefix/Suffix	42
Global AIM ID	43

GS1-128 AIM ID	44
Label ID	44
Label ID: Pre-loaded Sets	44
Label ID: Set Individually Per Symbology	45
.....	45
Label ID Control	45
Label ID Symbology Selection	46
Set Global Mid Label ID Characters	50
No Read String	51
CODE VERIFIER	52
Code Verifier Mode	52
Match String	53
Wrong Code String	54
Case Conversion	54
Character Conversion	55
Digital Output	57
Activation Event	58
Deactivation Event	59
Deactivation Timeout	59
Activation State	60
POWER SAVE	61
USB Suspend Mode	62
Sleep Mode Timeout	63
Reading Parameters	65
Illumination Mode	66
LED AND BEEPER INDICATORS	66
Power On Alert	66
Good Read: When to Indicate	67
Good Read Beep	67
Good Read Beep Length	68
Good Read LED Duration	69
Green Spot Duration	70
LED Indication	70
SCANNING FEATURES	71
Operating Mode	71
Phase Off Event	72
Phase Off Timeout	72
Serial Start Character	73
Serial Stop Character	73
Automatic Threshold	74
Test Mode Multiple	74
CAMERA CONTROL	75
Exposure Mode	75
Code Selection	77
DISABLE ALL SYMBOLOGIES	78
CODE EAN/UPC	79
Coupon Control	79
UPC-A	80
UPC-A Enable/Disable	80
UPC-A Check Character Transmission	80
Expand UPC-A to EAN-13	81
UPC-A Number System Character Transmission	81
UPC-A Minimum Reads	82
UPC-E	83
UPC-E Enable/Disable	83
UPC-E Check Character Transmission	83
Expand UPC-E to EAN-13	84
Expand UPC-E to UPC-A	84
UPC-E Number System Character Transmission	85
UPC-E Minimum Reads	85
GTIN FORMATTING	86
EAN 13 (JAN 13)	87

.....

EAN 13 Enable/Disable	87
EAN 13 Check Character Transmission	87
EAN-13 Flag 1 Character	88
EAN-13 ISBN Conversion	88
EAN 13 Minimum Reads	89
ISSN	90
ISSN Enable/Disable	90
EAN 8 (JAN 8)	91
EAN 8 Enable/Disable	91
EAN 8 Check Character Transmission	91
Expand EAN 8 to EAN 13	92
EAN 8 Minimum Reads	92
UPC/EAN GLOBAL SETTINGS	93
UPC/EAN Decoding Level	93
UPC/EAN Correlation	94
UPC/EAN Price Weight Check	94
In-Store Minimum Reads	95
ADD-ONS	96
Optional Add-ons	96
Optional Add-On Timer	97
Optional GS1-128 Add-On Timer	100
P2 Add-Ons Minimum Reads	103
P5 Add-Ons Minimum Reads	104
GS1-128 Add-Ons Minimum Reads	105
CODE 39	106
Code 39 Enable/Disable	106
Code 39 Check Character Calculation	106
Code 39 Check Character Transmission	107
Code 39 Start/Stop Character Transmission	108
Code 39 Full ASCII	108
Code 39 Quiet Zones	109
Code 39 Minimum Reads	110
Code 39 Decoding Level	111
Code 39 Length Control	112
Code 39 Set Length 1	113
Code 39 Set Length 2	114
Code 39 Interdigit Ratio	115
Code 39 Character Correlation	117
Code 39 Stitching	117
CODE 32 (ITAL PHARMACEUTICAL CODE)	118
Code 32 Enable/Disable	118
Code 32 Feature Setting Exceptions	118
Code 32 Check Char Transmission	119
Code 32 Start/Stop Character Transmission	119
CODE 39 CIP (FRENCH PHARMACEUTICAL)	120
Code 39 CIP Enable/Disable	120
CODE 128	121
Code 128 Enable/Disable	121
Expand Code 128 to Code 39	121
Code 128 Check Character Transmission	122
Code 128 Function Character Transmission	122
Code 128 Sub-Code Change Transmission	123
Code 128 Quiet Zones	124
Code 128 Minimum Reads	125
Code 128 Decoding Level	126
Code 128 Length Control	127
Code 128 Set Length 1	128
Code 128 Set Length 2	129
Code 128 Character Correlation	130
Code 128 Stitching	130
GS1-128	131
GS1-128 Enable	131

CODE ISBT 128	132
ISBT 128 Concatenation	132
ISBT 128 Concatenation Mode	132
ISBT 128 Dynamic Concatenation Timeout	133
ISBT 128 Advanced Concatenation Options	133
INTERLEAVED 2 OF 5 (I 2 OF 5)	134
I 2 of 5 Enable/Disable	134
I 2 of 5 Check Character Calculation	134
I 2 of 5 Check Character Transmission	135
I 2 of 5 Minimum Reads	136
2 of 5 Decoding Level	137
I 2 of 5 Length Control	138
I 2 of 5 Set Length 1	139
I 2 of 5 Set Length 2	140
I 2 of 5 Character Correlation	141
I 2 of 5 Stitching	141
STANDARD 2 OF 5	142
Standard 2 of 5 Enable/Disable	142
Standard 2 of 5 Check Character Calculation	142
Standard 2 of 5 Check Character Transmission	143
Standard 2 of 5 Minimum Reads	143
Standard 2 of 5 Decoding Level	144
Standard 2 of 5 Length Control	144
Standard 2 of 5 Set Length 1	145
Standard 2 of 5 Set Length 2	146
Standard 2 of 5 Character Correlation	147
Standard 2 of 5 Stitching	147
INDUSTRIAL 2 OF 5	148
Industrial 2 of 5 Enable/Disable	148
Industrial 2 of 5 Check Character Calculation	148
Industrial 2 of 5 Check Character Transmission	149
Industrial 2 of 5 Length Control	149
Industrial 2 of 5 Set Length 1	150
Industrial 2 of 5 Set Length 2	151
Industrial 2 of 5 Minimum Reads	152
Industrial 2 of 5 Character Correlation	152
Industrial 2 of 5 Stitching	153
CODE IATA	154
IATA Enable/Disable	154
IATA Check Character Transmission	154
DATALOGIC 2 OF 5	155
Datalogic 2 of 5 Enable/Disable	155
Datalogic 2 of 5 Check Character Calculation	155
Datalogic 2 of 5 Minimum Reads	156
Datalogic 2 of 5 Decoding Level	156
Datalogic 2 of 5 Length Control	157
Datalogic 2 of 5 Set Length 1	158
Datalogic 2 of 5 Set Length 2	159
Datalogic 2 of 5 Character Correlation	160
Datalogic 2 of 5 Stitching	160
CODABAR	161
Codabar Enable/Disable	161
Codabar Check Character Calculation	161
Codabar Check Character Transmission	162
Codabar Start/Stop Character Transmission	162
Codabar Start/Stop Character Set	163
Codabar Start/Stop Character Match	163
Codabar Quiet Zones	164
Codabar Minimum Reads	165
Codabar Decoding Level	166
Codabar Length Control	167
Codabar Set Length 1	168

Codabar Set Length 2	169
Codabar Interdigit Ratio	170
Codabar Character Correlation	172
Codabar Stitching	172
ABC CODABAR	173
ABC Codabar Enable/Disable	173
ABC Codabar Concatenation Mode	173
ABC Codabar Dynamic Concatenation Timeout	174
GS1 DATABAR™ OMNIDIRECTIONAL	175
GS1 DataBar™ Omnidirectional Enable/Disable	175
GS1 DataBar™ Omnidirectional GS1-128 Emulation	175
GS1 DataBar™ Omnidirectional Minimum Reads	176
GS1 DATABAR™ EXPANDED	177
GS1 DataBar™ Expanded Enable/Disable	177
GS1 DataBar™ Expanded GS1-128 Emulation	177
GS1 DataBar™ Expanded Minimum Reads	178
GS1 DataBar™ Expanded Length Control	178
GS1 DataBar™ Expanded Set Length 1	179
GS1 DataBar™ Expanded Set Length 2	180
GS1 DATABAR™ LIMITED	181
GS1 DataBar™ Limited Enable/Disable	181
GS1 DataBar™ Limited GS1-128 Emulation	181
GS1 DataBar™ Limited Minimum Reads	182
CODE 93	183
Code 93 Enable/Disable	183
Code 93 Check Character Calculation	183
Code 93 Check Character Transmission	184
Code 93 Length Control	184
Code 93 Set Length 1	185
Code 93 Set Length 2	186
Code 93 Minimum Reads	187
Code 93 Decoding Level	188
Code 93 Quiet Zones	189
Code 93 Character Correlation	190
Code 93 Stitching	190
MSI	191
MSI Enable/Disable	191
MSI Check Character Calculation	191
MSI Check Character Transmission	192
MSI Length Control	192
MSI Set Length 1	193
MSI Set Length 2	194
MSI Minimum Reads	195
MSI Decoding Level	196
MSI Stitching	197
MSI Character Correlation	197
PLESSEY	198
Plessey Enable/Disable	198
Plessey Check Character Calculation	199
Plessey Check Character Transmission	199
Plessey Length Control	200
Plessey Set Length 1	201
Plessey Set Length 2	202
Plessey Minimum Reads	203
Plessey Decoding Level	204
Plessey Stitching	205
Plessey Character Correlation	205
SOFTWARE CONFIGURATION STRINGS	207
Command Syntax	208
SERIAL CONFIGURATION STRINGS	210

Contents

REFERENCES.....	233
RS-232 Parameters	233
RS-232 Only	233
RS-232/USB COM Parameters	234
Data Editing	241
Global Prefix/Suffix	242
Global AIM ID	243
Label ID	244
Character Conversion	248
Scanner Data Formatting Control	248
Reading Parameters	251
Illumination Mode	251
Good Read LED Duration	251
Scanning Features	252
Operating Mode	252
On Line	252
Serial On Line	252
Automatic	253
Automatic/Trigger Object Sense	253
Test Mode	253
Test Mode Multiple	254
Camera Control	254
Power Save	254
USB Suspend	254
Sleep Mode Timeout	254
Digital Output	255
Symbologies	255
Decoding Level	255
Set Length	255
TECHNICAL SPECIFICATIONS.....	257
Standard Cable Pinouts	259
LED and Beeper Indications	260
Button and LED Status	260
Error Codes	261
STANDARD DEFAULTS	263
SAMPLE BARCODES.....	273
KEYPAD	277
RESERVED CHARACTERS.....	281
SCANCODE TABLES	283
Control Character Emulation	283
Single Press and Release Keys	283
Interface Type USB-Keyboard or USB-Keyboard for APPLE	284
Interface type USB-Keyboard Alt Mode	286
Microsoft Windows Codepage 1252	288
INDEX.....	289

Chapter 1

Introduction

About this Manual

This Product Reference Guide (PRG) is provided for users seeking advanced technical information, including connection, programming, maintenance and specifications.

Overview

[Chapter 1](#), (this chapter) presents information about manual conventions, and an overview of the reader, its features and operation.

[Chapter 2, Setup](#) presents information about unpacking and setting up the reader.

[Chapter 3, Configuration Using Barcodes](#) provides instructions and barcode labels for customizing your reader. There are different sections for interface types, general features, data formatting, symbology-specific and model-specific features.

[Chapter 4, Software Configuration Strings](#) describes how to configure certain models using serial strings.

[Chapter 5, References](#) provides background information and detailed instructions for more complex programming items.

[Appendix A, Technical Specifications](#) lists physical and performance characteristics, as well as environmental and regulatory specifications. It also provides standard cable pin-outs and LED/Beeper functions.

[Appendix B, Standard Defaults](#) references common factory default settings for reader features and options.

[Appendix C, Sample Barcodes](#) offers sample barcodes of several common symbologies.

[Appendix D, Keypad](#) includes numeric barcodes to be scanned for certain parameter settings.

[Appendix E, Scancode Tables](#) lists control character emulation information for the USB Keyboard interface.

Manual Conventions

The following conventions are used in this document. The symbols listed below are used in this manual to notify the reader of key issues or procedures that must be observed when using the reader:



Notes contain information necessary for properly diagnosing, repairing and operating the reader.



The **CAUTION** symbol advises you of actions that could damage equipment or property.

References

Current versions of this Product Reference Guide (PRG), Quick Reference Guide (QRG), the Datalogic Aladdin™ Configuration application, and any other manuals, instructions and utilities for this product can be downloaded from the website listed below. Alternatively, printed copies of most documentation can be purchased through your Datalogic reseller.

Technical Support

Datalogic Website Support

The Datalogic website (www.scanning.datalogic.com) is the complete source for technical support and information for Datalogic products. The site offers product support, product registration, warranty information, product manuals, product tech notes, software updates, demos, and instructions for returning products for repair.

Reseller Technical Support

An excellent source for technical assistance and information is an authorized Datalogic reseller. A reseller is acquainted with specific types of businesses, application software, and computer systems and can provide individualized assistance.

Telephone Technical Support

If you do not have internet or email access, you may contact Datalogic technical support at (541) 349-8283 or check the back cover of your manual for more contact information.

About the Reader

Typically, units are factory-programmed for the most common terminal and communications settings. If you need to modify any programmable settings, custom configuration can be accomplished by scanning the programming barcodes within this guide.

Two models are available, and are covered in this manual:

- Gryphon I GFS4170 - USB Fixed Mount Linear Imager Bar Code Reader
- Gryphon I GFS4150-9 - RS-232 Fixed Mount Linear Imager Bar Code Reader

Programming can also be performed using the Datalogic Aladdin™ Configuration application which is downloadable from the Datalogic website listed on the back cover of this manual. This multi-platform utility program allows device configuration using a PC. It communicates with the device using a serial or USB cable and can also create configuration barcodes to print.

Advances in the LED technology used in the imager-based readers significantly improve the illumination of the target field of view, resulting in higher scan efficiency.

See "[Interface Selection](#)" on page 13 for a listing and descriptions of available interface sets by model type.

Programming the Reader

Configuration Methods

Programming Barcodes

The reader is factory-configured with a standard set of default features. After scanning the interface barcode, you can select other options and customize your reader through use of the instructions and programming barcode labels available in the corresponding features section for your interface. Customizable settings for many features are found in "[Configuration Using Barcodes](#)" starting on page 17.

Some programming labels, like "[Restore Custom Defaults](#)" on page 16, require only the scan of the single label to enact the change. Most, however, require the reader to be placed in Programming Mode prior to scanning them. Scan an ENTER/EXIT barcode once to enter Programming Mode. Once the reader is in Programming Mode, scan a number of parameter settings before scanning the ENTER/EXIT barcode a second time, which will then accept your changes, exit Programming Mode and return the reader to normal operation.



There are some exceptions to the typical programming sequence described above. Please read the description and setting instructions carefully when configuring each programmable feature.

Datalogic Aladdin™

Datalogic Aladdin™ is a multi-platform utility program providing a quick and user-friendly configuration method via the RS-232/USB-COM interface. Aladdin is available for download from the Datalogic website. Aladdin allows you to program the reader by selecting configuration commands through a user-friendly graphical interface running on a PC. These commands are sent to the reader over the selected communication interface, or they can be printed as barcodes to be scanned.

Aladdin also provides the ability to perform a software upgrade for the connected device (see the Datalogic Aladdin™ Help On-Line for more details).

Software Configuration Strings

The reader can also be configured by using command strings. These strings can be sent via the RS232/USB-COM interface using a terminal emulator such as HyperTerminal.

Refer to Chapter 4 in this manual, "[Software Configuration Strings](#)," for configuration procedures using Serial Strings sent by the Host."

NOTES

Chapter 2

Setup

Unpacking

Check carefully to ensure the reader and any accessories ordered are present and undamaged. If any damage occurred during shipment, contact Datalogic Technical Support. Information is shown on [page 8](#).

KEEP THE PACKAGING. Should the unit ever require service, it should be returned in its original shipping container.

Setting Up the Reader

Follow the steps provided in this section to connect and get your reader up, and communicating with its host.

1. Connect the cable to the Host.
2. Go to [Interface Selection](#) and set the desired interface.
3. [Configure Interface Settings](#) (only if not using factory settings for that interface).
4. Go to [Software Version Transmission](#) (if modifications are needed from factory settings).

Installing the Interface Cable

RS-232 Serial Connection



Turn off power to the terminal/PC and connect the reader to the terminal/PC serial port via the RS-232 cable, as shown in Figure 1. If the terminal will not support POT (Power Off the Terminal) to supply reader power, use the approved power supply (AC Adapter). Plug the AC Adapter barrel connector into the socket on the RS-232 cable connector and the AC Adapter plug into a standard power outlet.

Figure 1. RS-232 Connection

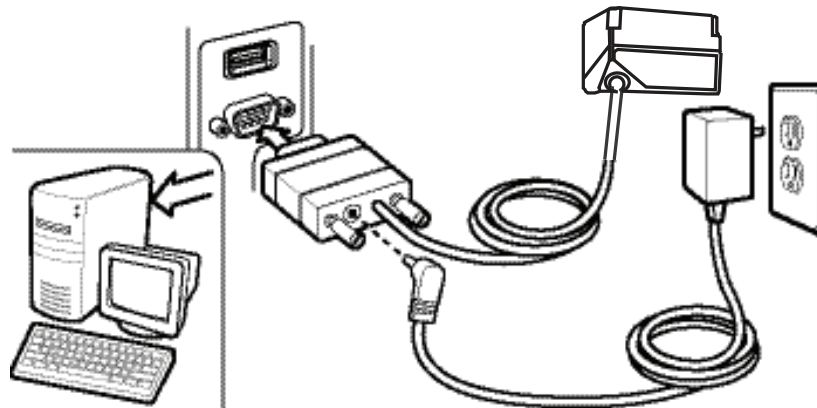

USB Connection



Connect the reader to a USB port on the terminal/PC using the USB cable for the interface type you ordered. Reference Figure 2.

Figure 2. USB connection

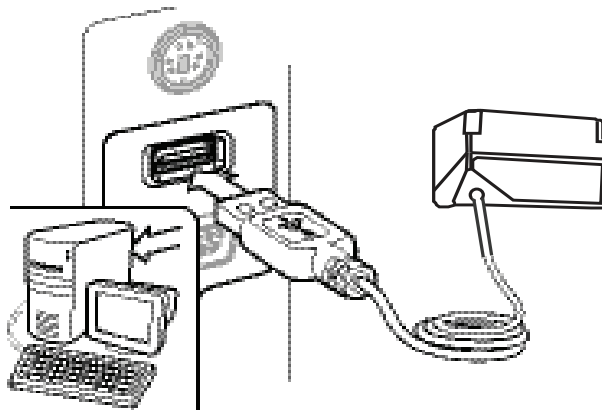

Specific cables are required for connection to different hosts. The connectors illustrated above are examples only. Actual connectors may vary from those illustrated, but the steps to connect the reader remain the same.

Interface Selection

Upon completing the physical connection between the reader and its host, proceed to Table 1 starting on page 14 to select the interface type the reader is connected to (for example, RS-232 or USB). Scan the appropriate barcode in that section to configure your system's correct interface type.

Each reader model will support one of the following sets of host interfaces:

GFS4150-9 Model

- RS-232-STD
- RS-232 Wincor-Nixdorf

GFS4170 Model

- USB-COM, USB-KBD, USB_KBD-ALT, USB-KBD-Apple

Setting the Interface

Scan the programming barcode from this section which selects the appropriate interface type matching the system the reader will be connected to. Next, proceed to the corresponding section in this manual (also listed in Table 1 starting on page 14) to configure any desired settings and features associated with that interface.



Unlike some programming features and options, interface selections require that you scan only one programming barcode label. DO NOT scan an ENTER/EXIT barcode prior to scanning an interface selection barcode.

Some interfaces require the scanner to start in the disabled state when powered up. If additional scanner configuration is desired while in this state, pull the trigger and hold it for five seconds. The scanner will change to a state that allows programming with barcodes.

Table 1. Available Interfaces

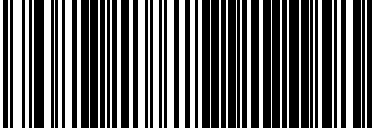
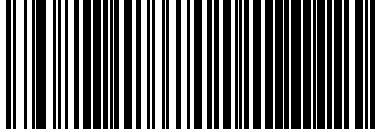
RS-232		FEATURES
 Select RS-232 STD	RS-232 standard interface	Set RS-232 Interface Features starting on page 21
 Select USB-COM-STD ^a	USB Com to simulate RS-232 standard interface	
 Select RS-232 Wincor-Nixdorf	RS-232 Wincor-Nixdorf	

a. Download the correct USB COM driver from the Datalogic Scanning website.

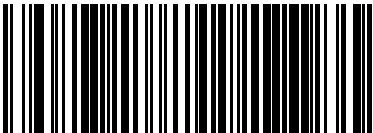
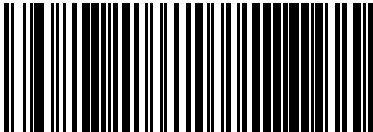
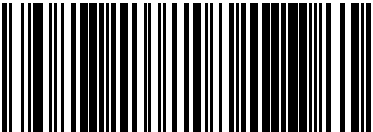
KEYBOARD		FEATURES
 Select USB Keyboard	USB Keyboard with standard key encoding	Set KEYBOARD Interface Features starting on page 33
USB Keyboard with alternate key encoding	 Select USB Alternate Keyboard	
 Select USB-KBD-APPLE	USB Keyboard for Apple computers	

Customizing Configuration Settings

Configure Interface Settings

If after scanning the interface barcode from the previous table, your installation requires you to select options to further customize your reader, turn to the appropriate section for your interface type in "Configuration Using Barcodes" starting on page 17.

- "RS-232 ONLY Interface" on page 21
- "RS-232/USB-Com Interfaces" on page 26
- "USB Keyboard Interfaces" on page 33

Global Interface Features

See "Global Interface Features" on page 19 for settings configurable by all interface types.

Software Version Transmission

The software version of the device can be transmitted over the RS-232 and Keyboard interfaces by scanning the following label.



Transmit Software Version

Resetting Product Configuration to Defaults

Restore Custom Defaults

If you aren't sure what programming options are in your imager, or you've changed some options and want to restore the Custom Default Configuration that may have been saved in the scanner, scan the Restore Custom Default Configuration barcode below. This will restore the custom configuration for the currently active interface.



Custom defaults are based on the interface type. Configure the imager for the correct interface before scanning this label.

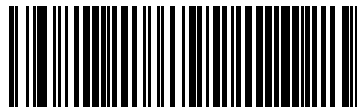

Restore Custom Default Configuration

Restore Factory Configuration

If you want to restore the Factory Configuration for your imager, scan the Restore Factory Configuration barcode below. The label restores the scanner configuration to the factory settings, including the interface type. The Label ID set is shown in the “Label ID” section on [page 44](#) of this manual.

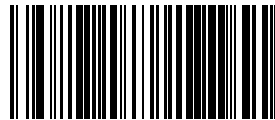

Restore Factory Configuration

The programming items listed in the following sections show the factory default settings for each of the menu commands.

Chapter 3

Configuration Using Barcodes

This and following sections provide programming barcodes to configure your reader by changing the default settings. For details about additional methods of programming, see [Configuration Methods on page 9](#).



You must first enable your reader to read barcodes in order to use this section. If you have not done this, go to [Setup, starting on page 11](#) and complete the appropriate procedure.

Configuration Parameters

Once the reader is set up, you can change the default parameters to meet your application needs. Refer to "[Standard Defaults](#)" [starting on page 263](#) for initial configuration in order to set the default values and select the interface for your application.

The following configuration parameters are applicable to all Gryphon models covered in this manual, unless otherwise indicated. The items are divided into logical groups, making it easy to find the desired function based on its reference group.

Interface Configuration:

- "[RS-232 ONLY Interface](#)" on page 21
- "[RS-232/USB-Com Interfaces](#)" on page 26
- "[USB Keyboard Interfaces](#)" on page 33

Parameters common to all interface applications:

- "[Data Format](#)" on page 41 gives options to control the messages sent to the Host system.
- "[Reading Parameters](#)" on page 65 control various operating modes and indicators status functioning.

Symbology-specific parameters:

- "[Code Selection](#)" on page 77 provides configuration of a personalized mix of codes, code families and their options.

Reading Configuration Barcodes



You must first enable your reader to read barcodes in order to use this section. If you have not done this, go to [Setup](#), starting on page 11 and complete the appropriate procedure.

To program features:

1. Scan the ENTER/EXIT PROGRAMMING barcode, available at the top of each programming page, when applicable.
2. Scan the barcode to set the desired programming feature. You may need to cover unused barcodes on the page, and possibly the facing page, to ensure that the reader reads only the barcode you intend to scan.
3. If additional input parameters are needed, go to [Appendix D, Keypad](#), and scan the appropriate characters from the keypad.



Additional information about many features can be found in the “References” chapter.

If you make a mistake before the last character, scan the CANCEL barcode to abort and not save the entry string. You can then start again at the beginning.

4. Complete the programming sequence by scanning the ENTER/EXIT PROGRAMMING barcode to exit Programming Mode.

For detailed descriptions, programming information and examples for setting selected configuration items, see [References](#), starting on page 233.



GLOBAL INTERFACE FEATURES

The following interface features are configurable by all interface types.

Host Commands — Obey/Ignore

This option specifies whether the reader will obey or ignore host commands. When set to ignore, the reader will ignore all host commands except for those necessary for:

- service mode
- flash programming mode
- keeping the interface active
- transmission of labels

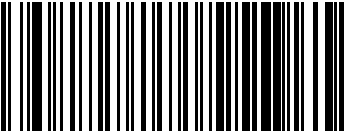
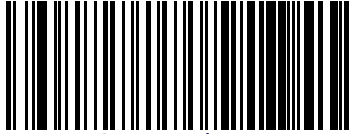
	 Host Commands = Obey
 Host Commands = Ignore	



NOTES

RS-232 ONLY INTERFACE

BAUD RATE on page 22
DATA BITS on page 23
STOP BITS on page 23
PARITY on page 24
HANDSHAKING CONTROL on page 25

Use the programming barcodes in this section if modifications to the standard RS-232 interface settings are necessary to meet your system's requirements. Additional settings which apply to both the RS-232 and USB interfaces are available in the next section, "RS-232/USB-Com Interfaces" starting on page 4-26.

Reference [Appendix B, Standard Defaults](#) for a listing of standard factory settings.

Baud Rate

See [page 233](#) for information on this feature.

	 <p>Baud Rate = 1200</p>
 <p>Baud Rate = 2400</p>	
	 <p>Baud Rate = 4800</p>
 <p>Baud Rate = 9600</p>	
	 <p>Baud Rate = 19,200</p>
 <p>Baud Rate = 38,400</p>	
	 <p>Baud Rate = 57,600</p>
 <p>Baud Rate = 115,200</p>	



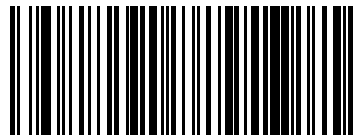

Data Bits

This parameter allows the reader to interface with devices requiring a 7-bit or 8-bit ASCII protocol for sending and receiving data.

	 <p>7 Data Bits</p>
 <p>8 Data Bits</p>	

Stop Bits

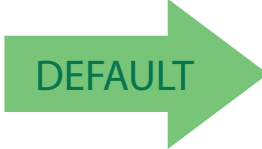
Set the number of stop bits to match host device requirements. See [page 233](#) for more information on this feature.

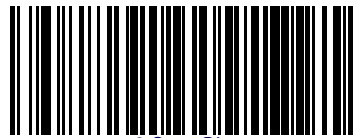
	 <p>1 Stop Bit</p>
 <p>2 Stop Bits</p>	



Parity

This feature specifies parity required for sending and receiving data. Select the parity type according to host device requirements. See [page 233](#) for more information.

	 Parity = None
 Parity = Even	
	 Parity = Odd



Handshaking Control

See [page 233](#) for more information about this feature.

	 <p>Handshaking Control = RTS</p>
 <p>Handshaking Control = RTS/CTS</p>	
	 <p>Handshaking Control = RTS/XON/XOFF</p>
 <p>Handshaking Control = RTS On/CTS</p>	
	 <p>Handshaking Control = RTS/CTS Scan Control</p>

RS-232/USB-COM INTERFACES

INTERCHARACTER DELAY on page 27
BEEP ON ASCII BEL on page 27
BEEP ON NOT ON FILE on page 28
ACK NAK OPTIONS on page 28
ACK CHARACTER on page 29
NAK CHARACTER on page 29
ACK NAK TIMEOUT VALUE on page 30
ACK NAK RETRY COUNT on page 30
ACK NAK ERROR HANDLING on page 31
INDICATE TRANSMISSION FAILURE on page 31
DISABLE CHARACTER on page 32
ENABLE CHARACTER on page 32

The programming barcodes in this chapter allow modifications to the standard RS-232 and USB-Com interfaces. Reference [Appendix B, Standard Defaults](#) for a listing of standard factory settings.



Intercharacter Delay

This parameter specifies the intercharacter delay between the end of one character and the beginning of the next. The delay can be set within a range of zero (0) to 990 milliseconds in 10ms increments. A setting of zero specifies no delay.

See [page 234](#) for more information.

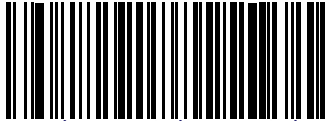
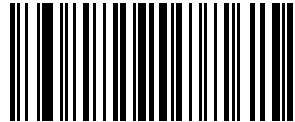
	 <p>Intercharacter Delay = No Delay</p>
 <p>Select Intercharacter Delay Setting</p>	<p>To configure this feature, scan the ENTER/EXIT PROGRAMMING MODE barcode above, then the barcode at left followed by the digits (in hex) from the Alphanumeric characters in Appendix D, Keypad representing your desired character(s). End by scanning the ENTER/EXIT barcode again.</p>

Make a mistake? Scan the CANCEL barcode to abort and not save the entry string. You can then start again.

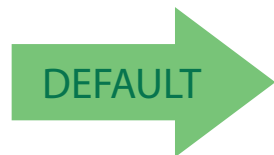

00 = No Intercharacter Delay

Beep On ASCII BEL

When this parameter is enabled, the reader issues a beep when a <BEL> character is detected on the RS-232 serial line. <BEL> is issued to gain a user's attention to an illegal entry or other important event.

 <p>Beep On ASCII BEL = Disable</p>	
	 <p>Beep On ASCII BEL = Enable</p>

Beep On Not on File

This option enables/disables the action of the reader to sound a three beep sequence upon receiving a Not-On-File (NOF) host command.

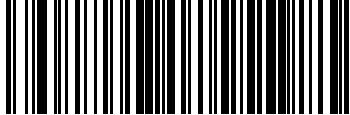
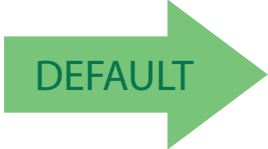
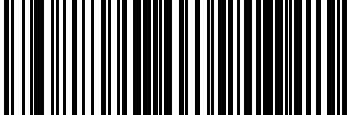
 Beep On Not On File = Disable	
	 Beep On Not On File = Enable

ACK NAK Options

This enables/disables the ability of the reader to support the RS-232 ACK/NAK protocol. See [page 235](#) for more information.

	 ACK/NAK Protocol = Disable ACK/NAK
 ACK/NAK Protocol = Enable for label transmission	
	 ACK/NAK Protocol = Enable for host-command acknowledge
 ACK/NAK Protocol = Enable for label transmission and host- command acknowledge	



ACK Character

This setting specifies an ASCII character or hex value to be used as the ACK character. ASCII characters or any hex value from 0 to 0xFF can be selected. See [page 235](#) for more information.



Setting to previously defined characters such as XON, XOFF, or host commands conflicts with normal operation of these characters. 8-bit data is not recognized when the option [Data Bits](#) has been set as 7 Data Bits.

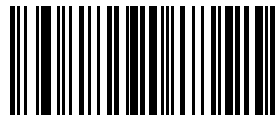

Select ACK Character Setting

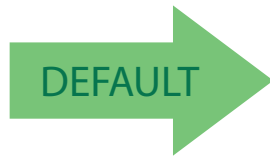

0x06 'ACK' Character

NAK Character

This setting specifies an ASCII character or hex value to be used as the NAK character. ASCII characters or any hex value from 0 to 0xFF can be selected. See [page 236](#) for more information.



Setting to previously defined characters such as XON, XOFF, or host commands conflicts with normal operation of these characters. 8-bit data is not recognized when the option [Data Bits](#) has been set as 7 Data Bits.



Select NAK Character Setting

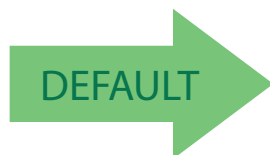

0x15 'NAK' Character



The ACK/NAK Characters must be different and must not contain reserved characters (see [Appendix E, Reserved Characters](#)).



ACK NAK Timeout Value

This option specifies the amount of time the reader waits for an ACK character from the host following label transmission. The selectable timeout range is 200 milliseconds to 15,000ms (15 seconds) in 200ms increments. A selection of 0 disables the timeout.

See [page 237](#) for more information on setting this feature.

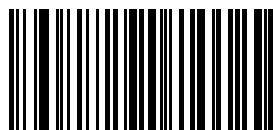

Select ACK NAK Timeout Value Setting

To configure this feature, scan the ENTER/EXIT PROGRAMMING MODE barcode above, then the barcode at left followed by the digits (in hex) from the Alphanumeric characters in [Appendix D, Keypad](#) representing your desired character(s). End by scanning the ENTER/EXIT barcode again.

Make a mistake? Scan the CANCEL barcode to abort and not save the entry string. You can then start again at the beginning.

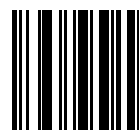

CANCEL

DEFAULT

01 ACK NAK Timeout value is 200ms

ACK NAK Retry Count

This feature specifies the number of times the reader retries a label transmission due to a retry condition. The selectable range is from 1 to 254 retries. A selection of 0 disables the count, and a selection of 255 specifies unlimited retries. See [page 238](#) for more information.

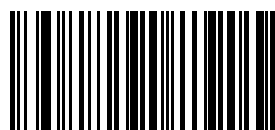

Select ACK NAK Retry Count Setting

To configure this feature, scan the ENTER/EXIT PROGRAMMING MODE barcode above, then the barcode at left followed by the digits (in hex) from the Alphanumeric characters in [Appendix D, Keypad](#) representing your desired character(s). End by scanning the ENTER/EXIT barcode again.

Make a mistake? Scan the CANCEL barcode to abort and not save the entry string. You can then start again at the beginning.

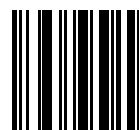

CANCEL

DEFAULT

003 = 3 Retries



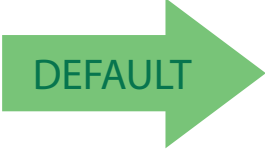
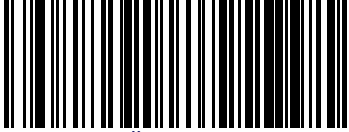
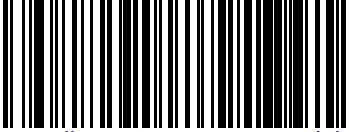
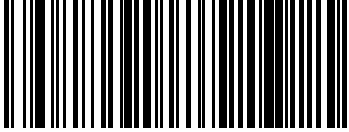

ACK NAK Error Handling

This feature specifies the method the reader uses to handle receive errors detected while waiting for an ACK character from the host.

	 <p>ACK NAK Error Handling = Ignore Errors Detected</p>
 <p>ACK NAK Error Handling = Process Error as Valid ACK Character</p>	
	 <p>ACK NAK Error Handling = Process Error as Valid NAK Character</p>

Indicate Transmission Failure

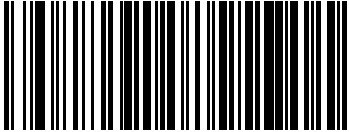
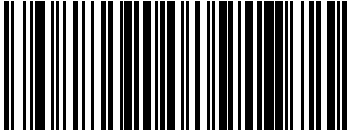
This option enables/disables the reader's ability to sound an error beep to indicate a transmission failure while in ACK/NAK mode.

	 <p>Indicate Transmission Failure = Disable Indication</p>
 <p>Indicate Transmission Failure = Enable Indication</p>	

Disable Character

Specifies the value of the RS-232 host command used to disable the reader. ASCII characters or any hex value from 0 to 0xFF can be selected.



Setting to previously defined characters such as XON, XOFF or host commands conflicts with normal operation of these characters. 8-bit data is not recognized when Data Bits are set as 7 Data Bits.

See [page 239](#) for more information on setting this feature.

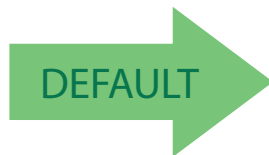

0x44 = Disable Character is 'D'

Enable Character

Specifies the value of the RS-232 host command used to enable the reader. ASCII characters or any hex value from 0 to 0xFF can be selected.



Setting to previously defined characters such as XON, XOFF or host commands conflicts with normal operation of these characters. 8-bit data is not recognized when Data Bits are set as 7 Data Bits.

See [page 240](#) in “References” for more information on setting this feature.



0x45 = Enable Character is 'E'



The Enable/Disable Characters must be different and must not contain reserved characters (see [Appendix E, Reserved Characters](#))

USB KEYBOARD INTERFACES

COUNTRY MODE on page 34
SEND CONTROL CHARACTERS on page 37
USB KEYBOARD SPEED on page 38

Use the programming barcodes in this chapter to select options for USB Keyboard Interfaces. Reference [Appendix B, Standard Defaults](#) for a listing of standard factory settings.

Information about control character emulation which applies to keyboard interfaces is listed in [Appendix F, Scancode Tables](#).

Country Mode

This feature specifies the country/language supported by the keyboard.

Only the USB Keyboard (without alternate key encoding) interface supports ALL Country Modes.

All other interfaces support ONLY the following Country Modes: U.S., Belgium, Britain, France, Germany, Italy, Spain, Sweden.

	 Country Mode = U.S.
 Country Mode = Belgium	
	 Country Mode = Britain
 Country Mode = Croatia	Supports only the interfaces listed in the Country Mode feature description.
Supports only the interfaces listed in the Country Mode feature description.	 Country Mode = Czechoslovakia

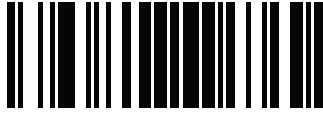

Country Mode — continued

 <p>Country Mode = Denmark</p>	<p>Supports only the interfaces listed in the Country Mode feature description.</p>
	 <p>Country Mode = France</p>
 <p>Country Mode = Germany</p>	
<p>Supports only the interfaces listed in the Country Mode feature description.</p>	 <p>Country Mode = Hungary</p>
 <p>Country Mode = Italy</p>	
<p>Supports only the interfaces listed in the Country Mode feature description.</p>	 <p>Country Mode = Japanese 106-key</p>
 <p>Country Mode = Norway</p>	<p>Supports only the interfaces listed in the Country Mode feature description.</p>

Country Mode — continued

 <p>Country Mode = Poland</p>	<p>Supports only the interfaces listed in the Country Mode feature description.</p>
<p>Supports only the interfaces listed in the Country Mode feature description.</p>	 <p>Country Mode = Portugal</p>
 <p>Country Mode = Romania</p>	<p>Supports only the interfaces listed in the Country Mode feature description.</p>
<p>Supports only the interfaces listed in the Country Mode feature description.</p>	 <p>Country Mode = Slovakia</p>
 <p>Country Mode = Spain</p>	
	 <p>Country Mode = Sweden</p>
 <p>Country Mode = Switzerland</p>	<p>Supports only the interfaces listed in the Country Mode feature description.</p>

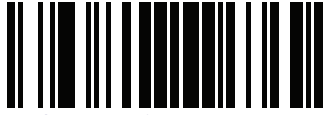

Send Control Characters

This feature Specifies how the reader transmits ASCII control characters to the host. Reference [Appendix F, Scancode Tables](#) for more information about control characters.

Options are as follows:

Control Character 00 . Characters from 00 to 0x1F are sent as control character Ctrl+Keys, special keys are located from 0x80 to 0xA1.

Control Character 01 . Characters from 00 to 0x1F are sent as control character Ctrl+Capital Key, special keys are located from 0x80 to 0xA1.

Control Character 02 . Special keys are located from 00 to 0x1F and characters from 0x80 to 0xFE are intended as an extended ASCII table (Microsoft Windows Codepage 1252 — see "Microsoft Windows Codepage 1252" on page [288](#)).

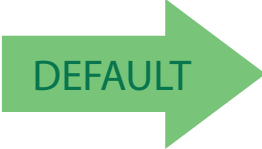
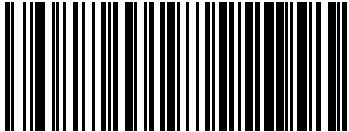
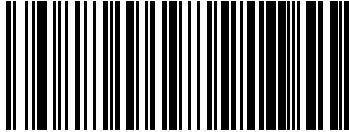
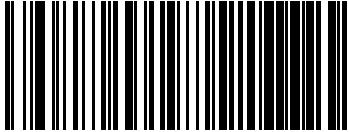
	 Send Control Characters = 00
 Send Control Characters = 01	
	 Send Control Characters = 02

USB Keyboard Speed

This option specifies the USB poll rate for a USB keyboard.

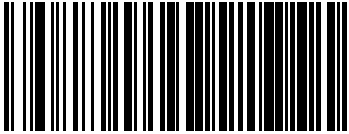
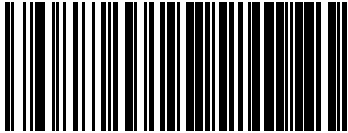
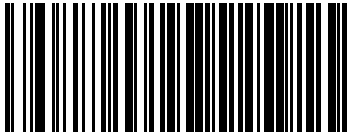
	 <p>USB Keyboard Speed = 1ms</p>
 <p>USB Keyboard Speed = 2ms</p>	
	 <p>USB Keyboard Speed = 3ms</p>
 <p>USB Keyboard Speed = 4ms</p>	
	 <p>USB Keyboard Speed = 5ms</p>

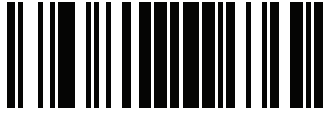

USB Keyboard Speed — continued

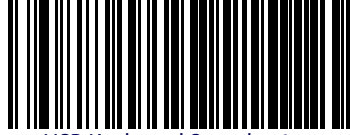

USB Keyboard Speed = 6ms

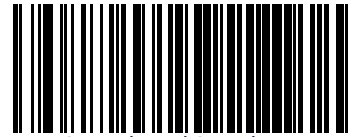

USB Keyboard Speed = 7ms

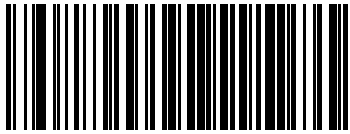

USB Keyboard Speed = 8ms

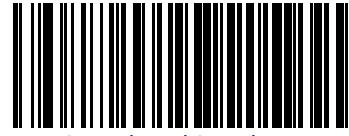

USB Keyboard Speed = 9ms

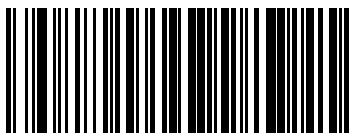

USB Keyboard Speed = 10ms

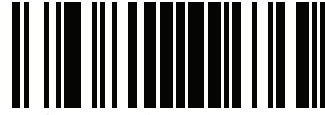

NOTES

DATA FORMAT

GLOBAL PREFIX/SUFFIX on page 42
GLOBAL AIM ID on page 43
GS1-128 AIM ID on page 44
LABEL ID starting on page 44
•Label ID: Pre-loaded Sets
•Label ID: Set Individually Per Symbology
•Label ID Control
•Label ID Symbology Selection
SET GLOBAL MID LABEL ID CHARACTERS on page 50
NO READ STRING on page 51
CODE VERIFIER starting on page 52
•Code Verifier Mode
•Match String
•Wrong Code String
CASE CONVERSION on page 54
CHARACTER CONVERSION on page 55

The features in this chapter can be used to build specific user-defined data into a message string. See “References” starting on [page 241](#) for more detailed instructions on setting these features.





ENTER/EXIT PROGRAMMING MODE

Data Format

Global Prefix/Suffix

This option sets up to 20 characters each from the set of ASCII characters or any hex value from 00 to FF. The characters may be added as a prefix (in a position before the barcode data, also called a header) and/or as a suffix (in a position following the barcode data, also called a footer). See [page 242](#) for more detailed instructions on setting this feature.

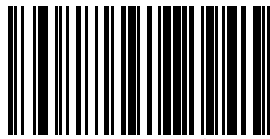
To configure this feature, scan the ENTER/EXIT PROGRAMMING MODE barcode above to place the unit in Programming Mode, then the “Set Global Prefix” or “Set Global Suffix,” barcode followed by the digits (in hex) from the Alphanumeric characters in [Appendix D, Keypad](#) representing your desired character(s). If less than the expected string of 20 characters are selected, scan the ENTER/EXIT barcode to terminate the string. Exit programming mode by scanning the ENTER/EXIT barcode again.

	 Set Global Prefix
 Set Global Suffix	

Make a mistake? Scan the CANCEL barcode to abort and not save the entry string. You can then start again at the beginning.

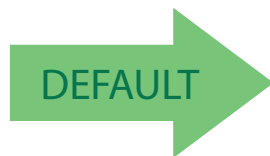

No Global Prefix
Global Suffix = 0x0D (CR)



Global AIM ID





This feature enables/disables addition of AIM IDs for all symbology types.

AIM label identifiers (as opposed to custom characters you select yourself as with label identifiers) can be included with scanned barcode data. AIM label identifiers consist of three characters as follows:

- A close brace character (ASCII '['), followed by...
- A code character (see the table below), followed by...
- A modifier character (the modifier character is symbol dependent).

SYMBOLGY	CHAR	SYMBOLGY	CHAR
UPC/EAN	E ^a	Code 128/GS1-128	C
Code 39 and Code 32	A	DataBar Omnidirectional, DataBar Expanded	e
Codabar	F	Standard 2 of 5	S
Interleaved 2 of 5	I	ISBN	X ^b
Code 93	G	Code 11	H

- UPC-A and UPC-E labels are converted to EAN 13 when adding AIM IDs.
- ISBN (X with a 0 modifier character)

GS1-128 AIM ID

If Global AIM ID is disabled, the AIM ID for GS1-128 can be enabled/disabled independently. The AIM ID for GS1-128 is a]C1,]C2 or]C3.

AIM IDs for other symbologies can be enabled/disabled independently as well. Contact Customer Support for assistance

	 GS1-128 AIM ID = Disable
 GS1-128 AIM ID = Enable	

Label ID

A Label ID is a customizable code of up to three ASCII characters (each can be one of hex 0x01-0xFF), used to identify a barcode (symbology) type. It can be appended previous to or following the transmitted barcode data depending upon how this option is enabled. This feature provides options for configuring custom Label IDs as a pre-loaded set (see "Label ID: Pre-loaded Sets" below) or individually per symbology (see "Label ID: Set Individually Per Symbology" on page 45). If you wish to program the reader to always include an industry standard label identifier for ALL symbology types, see the previous feature "Global AIM ID" on page 43.

See [Label ID, starting on page 244](#) of "References" for more information on setting this feature.

Label ID: Pre-loaded Sets

The reader supports two pre-loaded sets of Label IDs. See [Label ID: Pre-loaded Sets, starting on page 244](#) for details on the USA set and the EU set.





CAUTION

When changing from one Label ID set to another, all other reader configuration settings, including the host interface type, will be erased and set to the standard factory defaults. Any custom configuration or custom defaults will be lost.

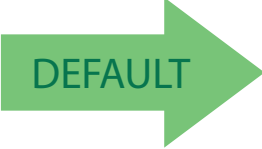

ENTER/EXIT PROGRAMMING MODE

Label ID: Set Individually Per Symbology

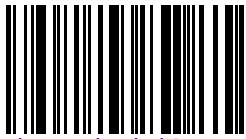
	 Label ID Pre-loaded Set = USA Set
 Label ID Pre-loaded Set = EU Set	

Label ID: Set Individually Per Symbology

This feature configures a Label ID individually for a single symbology. See [Label ID: Set Individually Per Symbology, starting on page 246](#) for detailed instructions on setting this feature.

Label ID Control

This option controls whether a Label ID is disabled, or sent as a prefix or suffix for a given symbology type.

	 Label ID Transmission = Disable
 Label ID Transmission = Enable as Prefix	
	 Label ID Transmission = Enable as Suffix

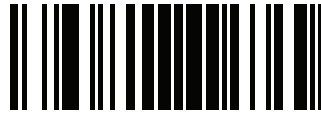

Label ID Symbology Selection

This option selects the symbology for which a Label ID is to be configured. See "Label ID" on page 44 or page 246 in "References" for more detailed instructions.

	 Set UPC-A Label ID Character(s)
 Set UPC-A/P2 Label ID Character(s)	
	 Set UPC-A/P5 Label ID Character(s)
 Set UPC-E Label ID Character(s)	
	 Set UPC-E/P2 Label ID Character(s)
 Set UPC-E/P5 Label ID Character(s)	
	 Set EAN 13 Label ID Character(s)



Label ID Symbology Selection — continued

 <p>Set EAN 13/P2 Label ID Character(s)</p>	
	 <p>Set EAN 13/P5 Label ID Character(s)</p>
 <p>Set EAN 8 Label ID Character(s)</p>	
	 <p>Set EAN 8/P2 Label ID Character(s)</p>
 <p>Set EAN 8/P5 Label ID Character(s)</p>	
	 <p>Set GTIN Label ID Character(s)</p>
 <p>Set GTIN/P2 Label ID Character(s)</p>	
	 <p>Set GTIN/P5 Label ID Character(s)</p>



Label ID Symbology Selection — continued

	 Set Code 39 Label ID Character(s)
 Set Code 32 Label ID Character(s)	
	 Set Code 39 CIP Label ID Character(s)
 Set Code 128 Label ID Character(s)	
	 Set GS1-128 Label ID Character(s)
 Set ISBT 128 Label ID Character(s)	
	 Set Interleaved 2 of 5 Label ID Character(s)
 Set Standard 2 of 5 Label ID Character(s)	



ENTER/EXIT PROGRAMMING MODE

Label ID Symbology Selection

Label ID Symbology Selection — continued

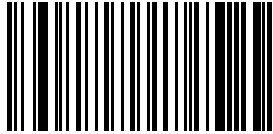
 <p>Set Industrial 2 of 5 Label ID Character(s)</p>	
	 <p>Set IATA Label ID Character(s)</p>
 <p>Set Datalogic 2 of 5 Label ID Character(s)</p>	
	 <p>Set Codabar Label ID Character(s)</p>
 <p>Set ABC Codabar Label ID Character(s)</p>	
	 <p>Set DataBar Omnidirectional Label ID Character(s)</p>
 <p>Set DataBar Expanded Label ID Character(s)</p>	



Data Format

ENTER/EXIT PROGRAMMING MODE

Label ID Symbology Selection — continued

	 Set DataBar Limited Label ID Character(s)
 Set Code 93 Label ID Character(s)	
	 Set MSI Label ID Character(s)
 Set Plessey Label ID Character(s)	

Set Global Mid Label ID Characters

Specifies mid-label ID that is added for transmission between the labels of a two-label pair.

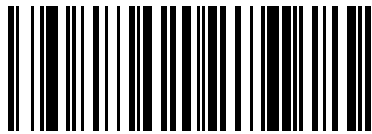
 Set Global Mid Label ID Character(s)	<p>To configure this feature, scan the ENTER/EXIT PROGRAMMING MODE barcode above, then the barcode at left followed by the digits (in hex) from the Alphanumeric characters in Appendix D, Keypad representing your desired character(s). End by scanning the ENTER/EXIT barcode again.</p>
---	---

Make a mistake? Scan the CANCEL barcode to abort and not save the entry string. You can then start again at the beginning.

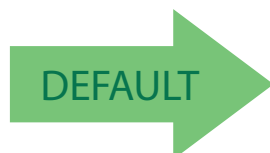

No Mid Label ID Character (00)



ENTER/EXIT PROGRAMMING MODE

No Read String

No Read String

This feature defines the string or character to be displayed in case of No Read during a reading phase (in On Line Mode only). It allows up to 20 characters, from the set of ASCII characters or any hex value from 00 to FE.

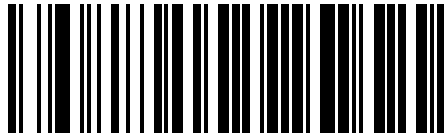

Select No Read String

To configure this feature, scan the ENTER/EXIT PROGRAMMING MODE barcode above, then the barcode at left followed by the digits (in hex) from the Alphanumeric characters in [Appendix D, Keypad](#) representing your desired character(s). If less than the expected string of 20 characters are selected, scan the ENTER/EXIT barcode to terminate the string. End by scanning the ENTER/EXIT barcode again.

Make a mistake? Scan the CANCEL barcode to abort and not save the entry string. You can then start again at the beginning.

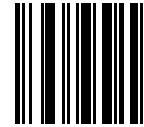

CANCEL

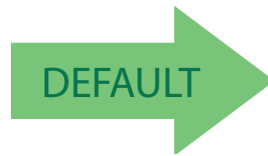

0x18 = (CAN)

See [No Read String](#) on page 248 for more information on setting this feature.



CODE VERIFIER

This feature allows the scanner to verify that all codes read and decoded match a defined string saved in its memory. It is valid when in On Line, Serial On Line, Automatic and Automatic (Object Sense) Operating Modes.

If the code read matches the code verifier Match String, then it is sent to the host through the configured port. If it does not match the code verifier Match String, you can specify whether to send either the Wrong Code or a defined Wrong String message to indicate the error.

See [page 249](#) in “References” for more information about these features.

Code Verifier Mode

Disable or specify parameters for Code Verifier Mode. See [page 249](#) in “References” for more information.

 <p>Disabled</p>	
	 <p>Transmit Wrong String</p>
 <p>Transmit Wrong Code</p>	



Match String

This feature allows you to define the string to be used as the match code for Code Verification. The Match String must be configured to include start/stop characters and check digits if their transmission is enabled. See [page 249](#) in “References” for more information.

It is possible to define the Match string by inserting:

- all printable characters
- non printable ASCII characters

No wild card characters are supported.



Set Match String

To configure this feature, scan the ENTER/EXIT PROGRAMMING MODE barcode above, then the barcode at left followed by the digits (in hex) from the Alphanumeric characters in [Appendix D, Keypad](#) representing your desired character(s). End by scanning the ENTER/EXIT barcode again.

Make a mistake? Scan the CANCEL barcode to abort and not save the entry string. You can then start again at the beginning.

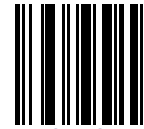

CANCEL



ENTER/EXIT PROGRAMMING MODE

Data Format

Wrong Code String

See [page 250](#) in “References” for more information about this feature.



Set Wrong Code String

To configure this feature, scan the ENTER/EXIT PROGRAMMING MODE barcode above, then the barcode at left followed by the digits (in hex) from the Alphanumeric characters in [Appendix D, Keypad](#) representing your desired character(s). End by scanning the ENTER/EXIT barcode again.

Make a mistake? Scan the CANCEL barcode to abort and not save the entry string. You can then start again at the beginning.

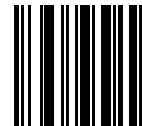

CANCEL

Case Conversion

This feature allows conversion of the case of all alphabetic characters to upper or lower case.



Case conversion affects ONLY scanned barcode data, and does not affect Label ID, Prefix, Suffix, or other appended data.

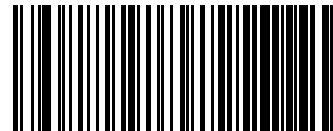
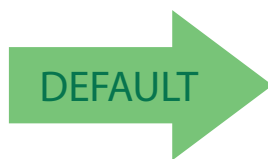

Case Conversion = Disable (no case conversion)

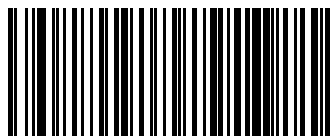

Case Conversion = Convert to upper case

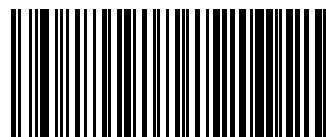

Case Conversion = Convert to lower case



ENTER/EXIT PROGRAMMING MODE

Character Conversion

Character Conversion

Character conversion is an eight byte configuration item. The eight bytes are 4 character pairs represented in hexadecimal ASCII values. The first character in the pair is the character that will be converted. The second character in the pair is the character to convert to. If the character to convert in a pair is FF, then no conversion is done.



If less than the expected string of 16 characters are selected, scan the ENTER/EXIT barcode twice to accept the selections and exit Programming Mode.



Configure Character Conversion

To configure this feature, scan the ENTER/EXIT PROGRAMMING MODE barcode above, then the barcode at left, followed by the digits (in hex) from the Alphanumeric characters in [Appendix D, Keypad](#) representing your desired character(s). End by scanning the ENTER/EXIT barcode again.

Make a mistake? Scan the CANCEL barcode to abort and not save the entry string. You can then start again at the beginning.



CANCEL

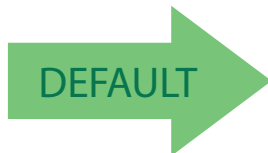

0xFFFFFFFFFFFFFFF
(No character conversion)

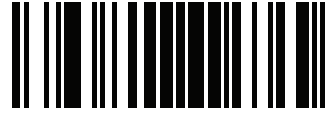

Data Format

ENTER/EXIT PROGRAMMING MODE

NOTES

DIGITAL OUTPUT

ACTIVATION EVENT on page 58
DEACTIVATION EVENT on page 59
DEACTIVATION TIMEOUT on page 59
ACTIVATION STATE on page 60

See [page 255](#) in “References” for more information about Digital Output.

Use the programming barcodes in this chapter to select options for Digital Outputs. Reference [Appendix B, Standard Defaults](#) for a listing of standard factory settings.

Activation Event

Defines the event activating the output.

 Disable	
	 Good Read
 No Read	
	 Wrong Code

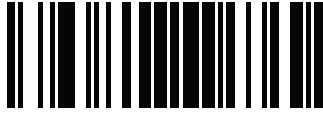



Deactivation Event

Defines the event deactivating the output. See [page 255](#) in “References” for more information about this feature.

 <p>Disable</p>	
	 <p>Timeout</p>
 <p>Reading Phase Active</p>	

Deactivation Timeout

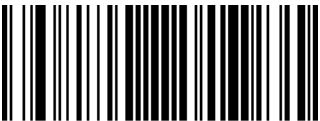
When Timeout is the selected Deactivation Event, this specifies the maximum duration of the output pulse.

 <p>Set Deactivation Timeout</p>	<p>To configure this feature, scan the ENTER/EXIT PROGRAMMING MODE barcode above, then the barcode at left followed by the digits (in hex) from the Alphanumeric characters in Appendix D, Keypad representing your desired character(s). Exit programming mode by scanning the ENTER/EXIT barcode again.</p>
<p>Make a mistake? Scan the CANCEL barcode to abort and not save the entry string. You can then start again at the beginning.</p> <div style="text-align: right;">  <p>CANCEL</p> </div>	

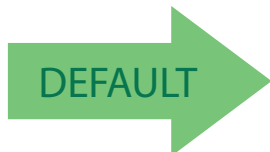

005 = 500 msec.



ENTER/EXIT PROGRAMMING MODE

Digital Output

Activation State

Determines the active state of the output.



Closed



Open

POWER SAVE

USB SUSPEND MODE on page 62
SLEEP MODE TIMEOUT on page 63

Use the programming barcodes in this chapter to select Power Save options. Reference [Appendix B, Standard Defaults](#) for a listing of standard factory settings.

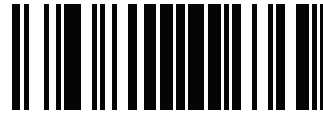

USB Suspend Mode

This setting enables/disables the ability of USB interfaces to enter suspend mode. See [page 254](#) in “References” for more information about this feature.



All LED indicators are off during USB Suspend.

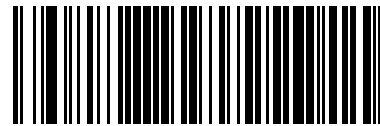
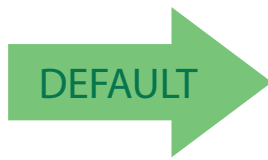

USB Suspend Mode = Disable

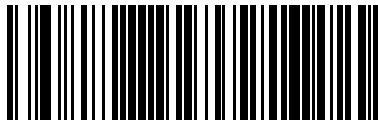

USB Suspend Mode = Enable

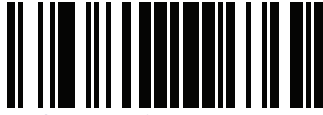



Sleep Mode Timeout

This feature sets the amount of time that the reader will be idle before it enters into a low power Sleep Mode. When in Sleep Mode the reader can no longer receive commands from the Host or base station until it is woken up again, either by a trigger pull or when an external trigger event occurs.

See [page 254](#) in “References” for more information about this feature.

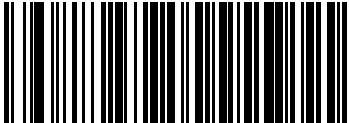

This feature is available only for the GFS4150-9 (RS-232 interface) in On Line operating mode.

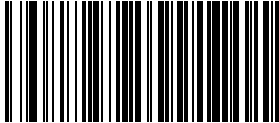
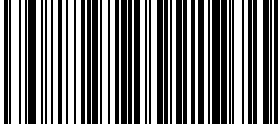
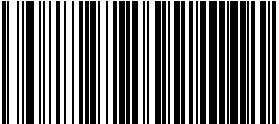
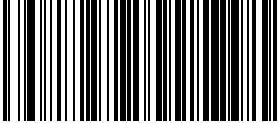
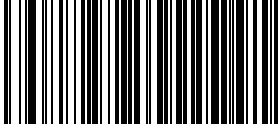
 Sleep Mode Timeout = Disable	
	 Sleep Mode Timeout = 10 Seconds
 Sleep Mode Timeout = 30 Seconds	
	 Sleep Mode Timeout = 1 minute
 Sleep Mode Timeout = 5 minutes	
	 Sleep Mode Timeout = 10 minutes

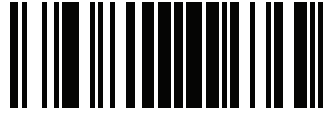

POWER SAVE

ENTER/EXIT PROGRAMMING MODE

NOTES

READING PARAMETERS

ILLUMINATION MODE on page 66
LED AND BEEPER INDICATORS on page 66
<ul style="list-style-type: none">• Power On Alert• Good Read: When to Indicate• Good Read Beep• Good Read Beep Length• Good Read LED Duration• Green Spot Duration• LED Indication
SCANNING FEATURES on page 71
<ul style="list-style-type: none">• Operating Mode• Phase Off Event• Phase Off Timeout• Serial Start Character• Serial Stop Character• Automatic Threshold• Test Mode Multiple
CAMERA CONTROL on page 75
<ul style="list-style-type: none">• Exposure Mode







ENTER/EXIT PROGRAMMING MODE

Reading Parameters

Illumination Mode

Selects the illumination mode for the reader. Options are:

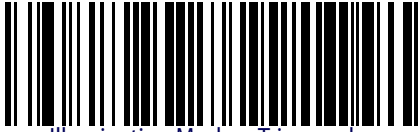
- Disabled: the illuminator is always off
- Enabled: the illuminator is always on
- Triggered: the illuminator is turned on when the reading phase starts, and turned off as soon as the code(s) are read or when the reading phase ends.

 <p>Illumination Mode = Disabled</p>	
	 <p>Illumination Mode = Enabled</p>
 <p>Illumination Mode = Triggered</p>	

LED AND BEEPER INDICATORS

Power On Alert

Disables or enables the indication (from the Beeper) that the reader is receiving power.

	 <p>Power On Alert = Disable (No Audible Indication)</p>
 <p>Power On Alert = Enable</p>	





Good Read: When to Indicate

This feature specifies when the reader will provide indication (beep and/or flash its green LED) upon successfully reading a barcode.

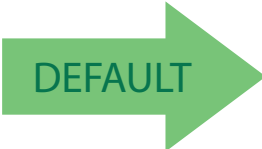

This option, which uses CTS, is only valid for RS-232 interfaces.

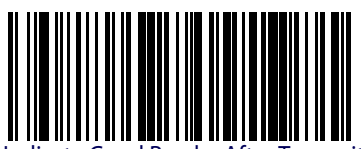







	 <p>Indicate Good Read = On Decode</p>
 <p>Indicate Good Read = After Transmit</p>	

Good Read Beep

Enable/Disable the good read beep following a good read of a label

	 <p>Enable Good Read Beep</p>
 <p>Disable Good Read Beep</p>	

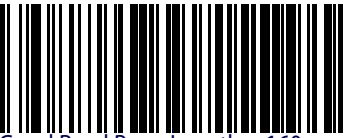
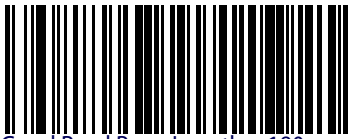
Good Read Beep Length

	 Good Read Beep Length = 60 msec
 Good Read Beep Length = 80 msec	
	 Good Read Beep Length = 100 msec
 Good Read Beep Length = 120 msec	
	 Good Read Beep Length = 140 msec
 Good Read Beep Length = 160 msec	
	 Good Read Beep Length = 180 msec
 Good Read Beep Length = 200 msec	



ENTER/EXIT PROGRAMMING MODE

Good Read LED Duration

Good Read LED Duration

This feature specifies the amount of time that the Good Read LED remains on following a good read. The good read LED on time can be set within a range of 100 milliseconds to 25,500 milliseconds (0.1 to 25.5 seconds) in 100ms increments.

See [page 251](#) in “References” for detailed instructions and examples for setting this feature.

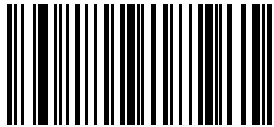

Select Good Read LED Duration Setting

To configure this feature scan the ENTER/EXIT PROGRAMMING MODE barcode above, then the barcode at left, followed by the digits (in hex) from the Alphanumeric characters in [Appendix D, Keypad](#) representing your desired character(s). End by scanning the ENTER/EXIT barcode again.

Make a mistake? Scan the CANCEL barcode to abort and not save the entry string. You can then start again at the beginning.

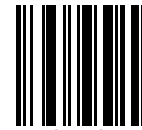

CANCEL

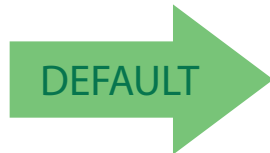

001 = Good Read LED stays on for 100 ms.



All LED indicators are off during sleep.



Green Spot Duration

Specifies the duration of the good read pointer beam after a good read.



	 Green Spot Duration = Disable (Green Spot is Off)
 Green Spot Duration = Short (300 msec)	
	 Green Spot Duration = Medium (500 msec)
 Green Spot Duration = Long (800 msec)	

LED Indication

Specifies when the scanner's LEDs will provide notification of successful reading of a barcode.

Selections:

- On Decode = Indicate Good Read immediately after decoding.
- After Transmission = Indicate Good Read after code transmission to host.

 LED Indication = On Decode	
	 LED Indication = After Transmission



SCANNING FEATURES

Operating Mode

Selects the reader's scan operating mode. See [page 252](#) in “References” for more information.

 On Line	
	 Serial On Line
 Automatic	
	 Automatic (Object Sense)
 Test Mode	



The barcode must remain steady before the reader in order for the Test mode to work properly.



Phase Off Event

 Trigger Stop	
	 Timeout
 Trigger Stop - Timeout	

Phase Off Timeout

Timeout can be set within a range of 40 milliseconds to 5100 milliseconds (0.04 to 5.1 seconds) in 20 ms increments.

 Select Automatic Threshold	<p>To configure this feature scan the ENTER/EXIT PROGRAMMING MODE barcode above, then the barcode at left, followed by the digits (in hex) from the Alphanumeric characters in Appendix D, Keypad representing your desired character(s). End by scanning the ENTER/EXIT barcode again.</p>
---	---

Make a mistake? Scan the CANCEL barcode to abort and not save the entry string. You can then start again at the beginning.

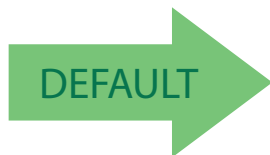

100 = Timeout set on for 2 seconds



ENTER/EXIT PROGRAMMING MODE

Serial Start Character

Serial Start Character

See [page 253](#) in “References” for more information.

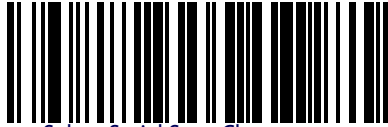

Select Serial Start Characters

To configure this feature scan the ENTER/EXIT PROGRAMMING MODE barcode above, then the barcode at left, followed by the digits (in hex) from the Alphanumeric characters in [Appendix D, Keypad](#) representing your desired character(s). End by scanning the ENTER/EXIT barcode again.

Make a mistake? Scan the CANCEL barcode to abort and not save the entry string. You can then start again at the beginning.

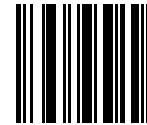

CANCEL

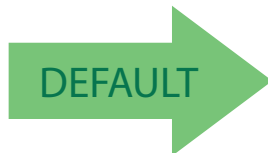

0x02 = Serial Start Character is [02 STX]

Serial Stop Character

See [page 253](#) in “References” for more information.

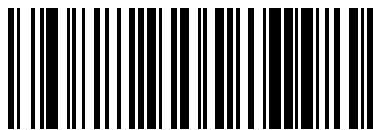

Select Serial Stop Characters

To configure this feature scan the ENTER/EXIT PROGRAMMING MODE barcode above, then the barcode at left, followed by the digits (in hex) from the Alphanumeric characters in [Appendix D, Keypad](#) representing your desired character(s). End by scanning the ENTER/EXIT barcode again.

Make a mistake? Scan the CANCEL barcode to abort and not save the entry string. You can then start again at the beginning.

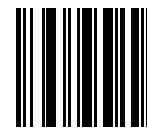

CANCEL

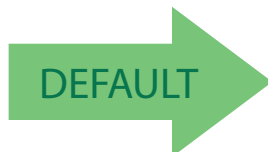

0x03 = Serial Stop Character is [03 ETX]



The Serial Start/Stop Characters must be different and must not contain reserved characters (see [Appendix E, Reserved Characters](#))



ENTER/EXIT PROGRAMMING MODE

Reading Parameters

Automatic Threshold

See [page 253](#) in “References” for more information.



Select Automatic Threshold

To configure this feature scan the ENTER/EXIT PROGRAMMING MODE barcode above, then the barcode at left, followed by the digits (in hex) from the Alphanumeric characters in [Appendix D, Keypad](#) representing your desired character(s). End by scanning the ENTER/EXIT barcode again.

Make a mistake? Scan the CANCEL barcode to abort and not save the entry string. You can then start again at the beginning.



CANCEL

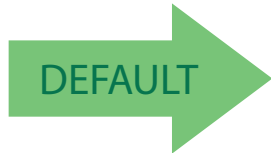

0x0A = 10

Test Mode Multiple

This parameter is active only in Test Mode.

Disable: Test mode is possible only for a single barcode

Enable: Test mode is possible for one or more barcodes at the mean time.



Enable Test Mode Multiple

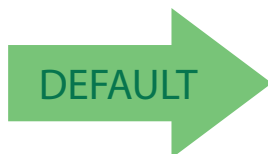



Disable Test Mode Multiple

CAMERA CONTROL

Exposure Mode

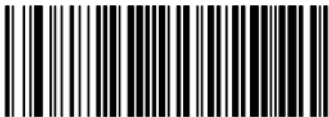
Strobed Exposure Mode: For any selectable scanning mode, performance on moving barcodes can be improved by flashing the scanner's lighting (strobe mode). The scanner strobes at a very high frequency, so the change in lighting may not be apparent. When enabled, the scanner can read codes moving at up to 1m/sec, depending on the bar size and direction the code is moving.

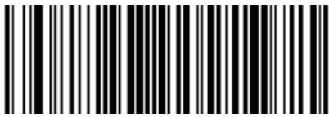
 <p>Continuous</p>	
	 <p>Strobed</p>

NOTES

CODE SELECTION

The reader supports the following symbologies (barcode types). Symbology-dependent options for each symbology are included in this chapter.

DISABLE ALL SYMBOLOGIES on page 78	
CODE EAN/UPC on page 79	INTERLEAVED 2 OF 5 (I 2 OF 5) on page 134
• Coupon Control	STANDARD 2 OF 5 on page 142
• UPC-A	INDUSTRIAL 2 OF 5 on page 148
• UPC-E	• Code IATA
• EAN 13 (Jan 13)	DATALOGIC 2 OF 5 on page 155
• ISSN	CODABAR on page 161
• EAN 8 (Jan 8)	• ABC Codabar
• UPC/EAN Global Settings	GS1 DATABAR™ OMNIDIRECTIONAL on page 175
CODE 39 on page 106	• GS1 DataBar™ Omnidirectional
• Code 32 (ITAL Pharmaceutical Code)	• GS1 DataBar™ Expanded
• Code 39 CIP (French Pharmaceutical)	• GS1 DataBar™ Limited
CODE 128 on page 121	CODE 93 on page 183
• GS1-128	MSI on page 191
CODE ISBT 128 on page 132	PLESSEY on page 198

Default settings are indicated for each feature/option with a green arrow. Also reference [Appendix B, Standard Defaults](#) for a listing of the most widely used set of standard factory settings. That section also provides space to record any custom settings needed or implemented for your system.

To set most features:

1. Scan the ENTER/EXIT PROGRAMMING barcode at the top of applicable programming pages.
2. Scan the correct barcode to set the desired programming feature or parameter. You may need to cover unused barcodes on the page, and possibly the facing page, to ensure that the reader reads only the barcode you intend to scan.

3. If additional input parameters are needed, go to [Appendix D, Keypad](#), and scan the appropriate characters from the keypad.



Additional information about many features can be found in the “References” chapter.

If you make a mistake before the last character, scan the CANCEL barcode to abort and not save the entry string. You can then start again at the beginning.

4. Complete the programming sequence by scanning the ENTER/EXIT PROGRAMMING barcode to exit Programming Mode.

DISABLE ALL SYMBOLOGIES

Use this feature to disable all symbologies.

1. Scan the ENTER/EXIT PROGRAMMING barcode below.
2. Scan the Disable All Symbologies barcode.
3. Complete the programming sequence by scanning the ENTER/EXIT PROGRAMMING barcode.

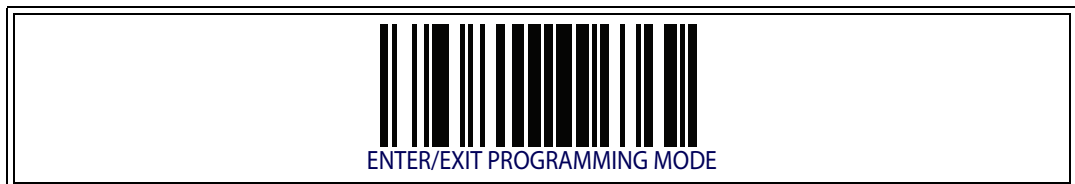



This does not disable the reading of programming labels.



CODE EAN/UPC

Coupon Control

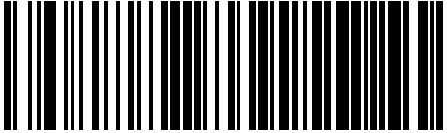
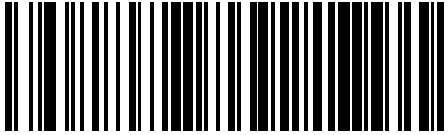
This feature is used to control the reader's method of processing coupon labels.

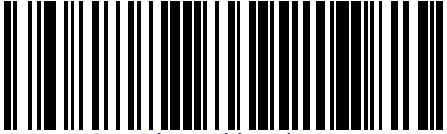
	 Coupon Control = Allow all coupon barcodes to be decoded
 Coupon Control = Enable only UPCA coupon decoding	
	 Coupon Control = Enable only GS1 DataBar™ coupon decoding



Code EAN/UPC

ENTER/EXIT PROGRAMMING MODE

UPC-A

The following options apply to the UPC-A symbology.



UPC-A Enable/Disable

When disabled, the reader will not read UPC-A barcodes.

	 UPC-A = Disable
 UPC-A = Enable	

UPC-A Check Character Transmission

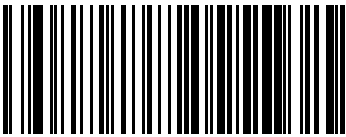
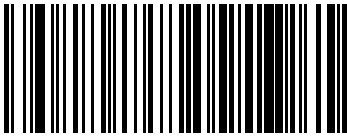

Enable this option to transmit the check character along with UPC-A barcode data.

	 UPC-A Check Character Transmission = Don't Send
 UPC-A Check Character Transmission = Send	



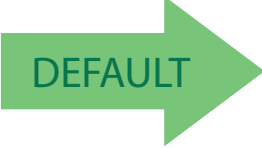

Expand UPC-A to EAN-13

Expands UPC-A data to the EAN-13 data format. Selecting this feature also changes the symbology ID to match those required for EAN-13.

	 UPC-A to EAN-13 = Don't Expand
 UPC-A to EAN-13 = Expand	

UPC-A Number System Character Transmission

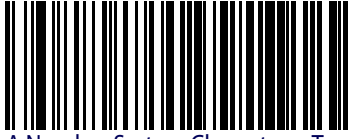



This feature enables/disables transmission of the UPC-A number system character.

	 UPC-A Number System Character = Do not transmit
 UPC-A Number System Character = Transmit	

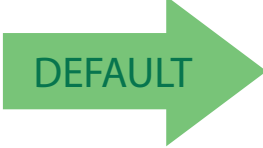

UPC-A Minimum Reads

This feature specifies the minimum number of consecutive times a UPC-A label must be decoded before it is accepted as a good read.

	 UPC-A Minimum Reads = 1
 UPC-A Minimum Reads = 2	
	 UPC-A Minimum Reads = 3
 UPC-A Minimum Reads = 4	





UPC-E

The following options apply to the UPC-E symbology.

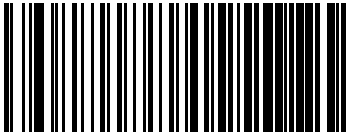

UPC-E Enable/Disable

When disabled, the reader will not read UPC-E barcodes.

	 UPC-E = Disable
 UPC-E = Enable	

UPC-E Check Character Transmission

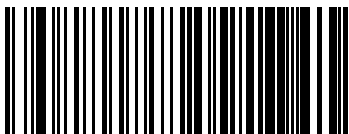
Enable this option to transmit the check character along with UPC-E barcode data.

	 UPC-E Check Character Transmission = Don't Send
 UPC-E Check Character Transmission = Send	

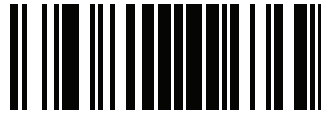

Expand UPC-E to EAN-13

Expands UPC-E data to the EAN-13 data format. Selecting this feature also changes the symbology ID to match those required for EAN-13.

	UPC-E to EAN-13 = Don't Expand

Expand UPC-E to UPC-A



Expands UPC-E data to the UPC-A data format.

	UPC-E to UPC-A = Don't Expand





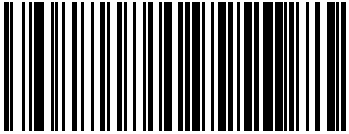
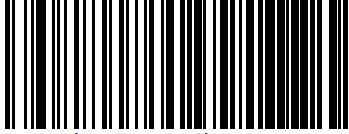

UPC-E Number System Character Transmission

This feature enables/disables transmission of the UPC-E system number character.

	 <p>UPC-E Number System Character = Do not transmit</p>
 <p>UPC-E Number System Character = Transmit</p>	

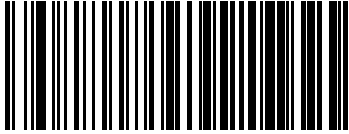
UPC-E Minimum Reads

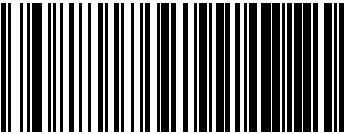
Specifies the minimum number of consecutive times a UPC-E label must be decoded before it is accepted as a good read.

	 <p>UPC-E Minimum Reads = 1</p>
 <p>UPC-E Minimum Reads = 2</p>	
	 <p>UPC-E Minimum Reads = 3</p>
 <p>UPC-E Minimum Reads = 4</p>	



GTIN FORMATTING

This feature enables/disables the ability to convert UPC-E, UPC-A, EAN 8, and EAN 13 labels into the GTIN 14-character format.

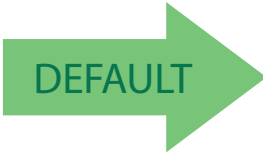
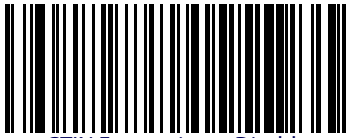
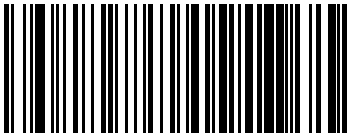

If add-on information is present on the base label prior to the conversion taking place, the add-on information will be appended to the converted GTIN label.

	 <p>GTIN Formatting = Disable</p>
 <p>GTIN Formatting = Enable</p>	



EAN 13 (JAN 13)

The following options apply to the EAN 13 (Jan 13) symbology.

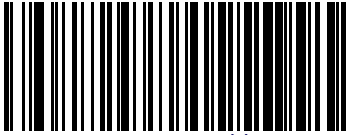

EAN 13 Enable/Disable

When disabled, the reader will not read EAN 13/JAN 13 barcodes.

	 EAN 13 = Disable
 EAN 13 = Enable	

EAN 13 Check Character Transmission

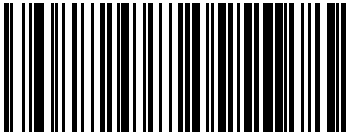
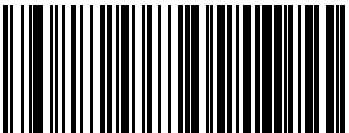
Enable this option to transmit the check character along with EAN 13 barcode data.

	 EAN 13 Check Character Transmission = Don't Send
 EAN 13 Check Character Transmission = Send	



EAN-13 Flag 1 Character

Enables/disables transmission of an EAN/JAN13 Flag1 character. The Flag 1 character is the first character of the label.

	 EAN-13 Flag 1 Char= Don't transmit
 EAN-13 Flag 1 Char= Transmit	

EAN-13 ISBN Conversion

This option enables/disables conversion of EAN 13/JAN 13 Bookland labels starting with 978 to ISBN labels.

	 EAN-13 ISBN Conversion = Disable
 EAN-13 ISBN Conversion = Convert to ISBN	



EAN 13 Minimum Reads

This feature specifies the minimum number of consecutive times an EAN 13 label must be decoded before it is accepted as good read.

	 EAN 13 Minimum Reads = 1
 EAN 13 Minimum Reads = 2	
	 EAN 13 Minimum Reads = 3
 EAN 13 Minimum Reads = 4	





ISSN

The following options apply to the ISSN symbology.

ISSN Enable/Disable

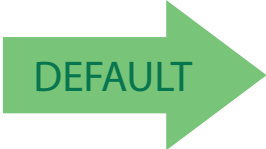
Enables/disables conversion of EAN/JAN13 Bookland labels starting with 977 to ISSN labels.





EAN 8 (JAN 8)

The following options apply to the EAN 8 (Jan 8) symbology.

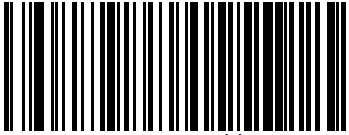
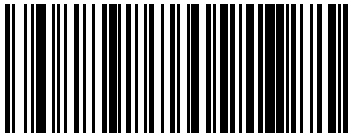

EAN 8 Enable/Disable

When disabled, the reader will not read EAN 8/JAN 8 barcodes.

	 <p>EAN 8 = Disable</p>
 <p>EAN 8 = Enable</p>	

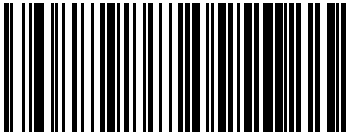
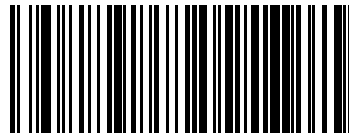

EAN 8 Check Character Transmission

Enable this option to transmit the check character along with EAN 8 barcode data.

	 <p>EAN 8 Check Character Transmission = Don't Send</p>
 <p>EAN 8 Check Character Transmission = Send</p>	

Expand EAN 8 to EAN 13

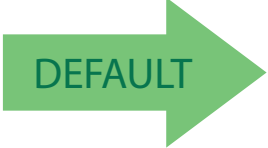
Enable this option to expand EAN 8/JAN 8 labels to EAN 13/JAN 13.

	 <p>Expand EAN 8 to EAN 13 = Disable</p>
 <p>Expand EAN 8 to EAN 13 = Enable</p>	

EAN 8 Minimum Reads

This feature specifies the minimum number of consecutive times an EAN 8 (Jan 8) label must be decoded before it is accepted as good read.

	 <p>EAN 8 Minimum Reads = 1</p>
 <p>EAN 8 Minimum Reads = 2</p>	
	 <p>EAN 8 Minimum Reads = 3</p>
 <p>EAN 8 Minimum Reads = 4</p>	







UPC/EAN GLOBAL SETTINGS

This section provides configuration settings for UPC-A, UPC-E, EAN 13 and EAN 8 symbologies, and affects all of these unless otherwise marked for each feature description.

UPC/EAN Decoding Level

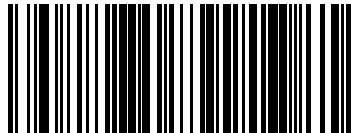
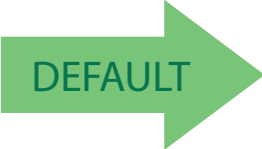
Decoding Levels are used to configure a barcode symbology decoder to be very aggressive to very conservative depending on a particular customer's needs.

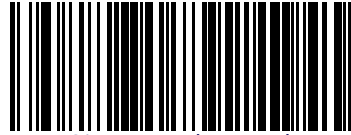
See [page 255](#) for more information on this feature.

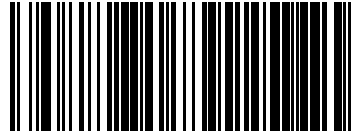
 UPC/EAN Decoding Level = 1 (Conservative)	
	 UPC/EAN Decoding Level = 2
 UPC/EAN Decoding Level = 3	
	 UPC/EAN Decoding Level = 4
 UPC/EAN Decoding Level = 5 (Aggressive)	

UPC/EAN Correlation

When correlation is enabled, the reader will combine label data from multiple scans when decoding. This will help the scanner read labels that have spots, voids and/or damaged areas. Enabling correlation will also increase the chances that a label will be read incorrectly.

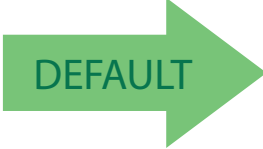
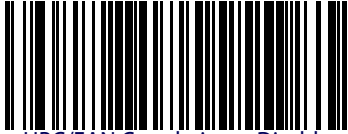
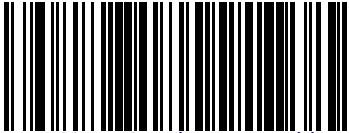
	 UPC/EAN Correlation = Disable
 UPC/EAN Correlation = Enable	

UPC/EAN Price Weight Check

This feature enables/disables calculation and verification of price/weight check digits.

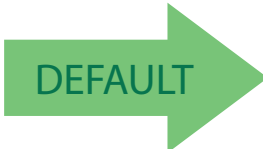
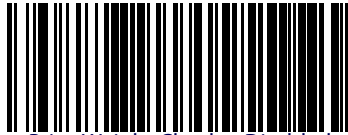
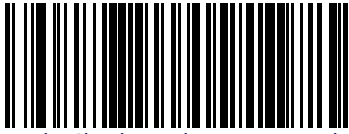
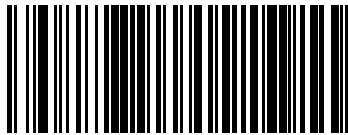
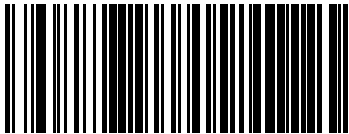
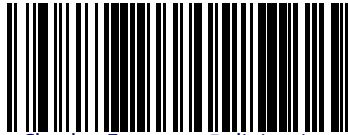

	 Price Weight Check = Disabled
 Price Weight Check = 4-digit price-weight check	
	 Price Weight Check = 5-digit price-weight check
 Price Weight Check = European 4-digit price-weight check	
	 Price Weight Check = European 5-digit price-weight check



In-Store Minimum Reads

This feature specifies the minimum number of consecutive times an in-store label must be decoded before it is accepted as good read.

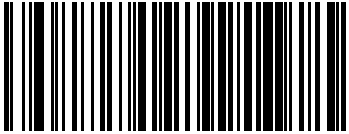
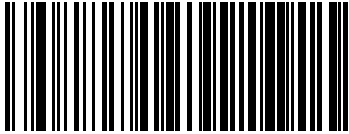
In-store labels are defined as UPC-A labels with a number-system character of 2 or 4 as well as EAN 8 and EAN 13 labels with a Flag1 character of 2 or an EAN 13 label starting with the three characters '980'.

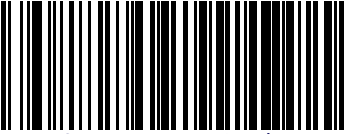
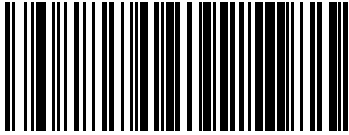
	 In-Store Minimum Reads = 1
 In-Store Minimum Reads = 2	
	 In-Store Minimum Reads = 3
 In-Store Minimum Reads = 4	



ADD-ONS

Contact Customer Support for advanced programming of optional and conditional add-ons.

Optional Add-ons

The reader can be enabled to optionally read the following add-ons (supplementals):



If a UPC/EAN base label and an add-on are both decoded, the reader will transmit the base label and add-on. If a UPC/EAN base label is decoded without an add-on, the base label will be transmitted without an add-on. Conditional add-on settings (if enabled) are considered by the reader before optional add-on settings.

	 Optional Add-Ons = Disable P2
 Optional Add-Ons = Enable P2	
	 Optional Add-Ons = Disable P5
 Optional Add-Ons = Enable P5	
	 Optional Add-Ons = Disable GS1-128
 Optional Add-Ons = Enable GS1-128	





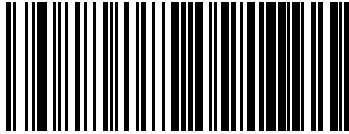
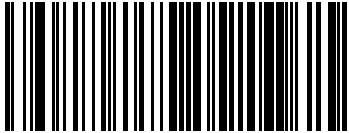
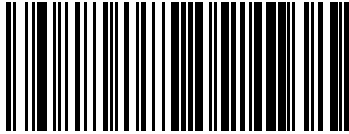
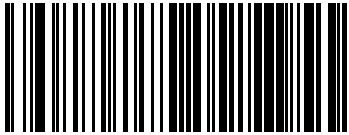
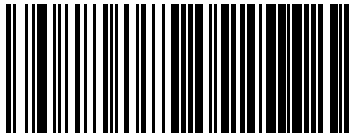

Optional Add-On Timer

This option sets the time the reader will look for an add-on when an add-on fragment has been seen and optional add-ons are enabled. (Also see "Optional GS1-128 Add-On Timer" on page 100.)

 Optional Add-on Timer = 10ms	
	 Optional Add-on Timer = 20ms
 Optional Add-on Timer = 30ms	
	 Optional Add-on Timer = 40ms
 Optional Add-on Timer = 50ms	

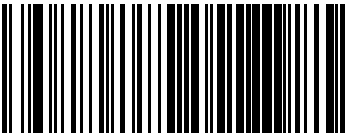

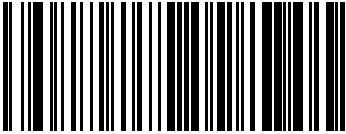
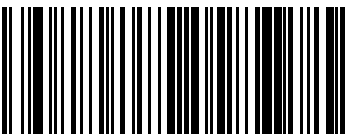
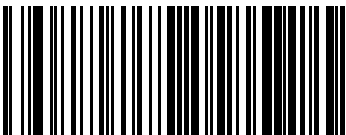
Optional Add-On Timer — cont.





	 Optional Add-on Timer = 60ms
 Optional Add-on Timer = 70ms	
	 Optional Add-on Timer = 100ms
 Optional Add-on Timer = 120ms	
	 Optional Add-on Timer = 140ms
 Optional Add-on Timer = 160ms	

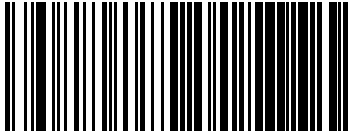

ENTER/EXIT PROGRAMMING MODE

Optional Add-On Timer

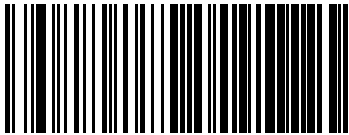
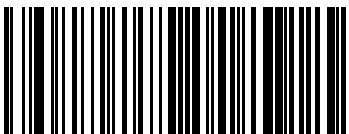
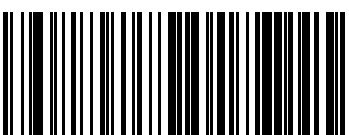
Optional Add-On Timer — cont.

	 Optional Add-on Timer = 180ms
 Optional Add-on Timer = 200ms	
	 Optional Add-on Timer = 220ms
 Optional Add-on Timer = 240ms	
	 Optional Add-on Timer = 260ms
 Optional Add-on Timer = 280ms	
	 Optional Add-on Timer = 300ms



Optional GS1-128 Add-On Timer

This option sets the timer expiration value to read the added part after reading the linear EAN/UPC part. For UPC/EAN add-ons other than those of that type, see "Optional Add-On Timer" on page 97.

	 Optional GS1-128 Add-On Timer = Disable
 Optional GS1-128 Add-On Timer = 10ms	
	 Optional GS1-128 Add-On Timer = 20ms
 Optional GS1-128 Add-On Timer = 30ms	
	 Optional GS1-128 Add-On Timer = 40ms
 Optional GS1-128 Add-On Timer = 50ms	



ENTER/EXIT PROGRAMMING MODE

Optional GS1-128 Add-On Timer

Optional GS1-128 Add-On Timer — cont.

	 <p>Optional GS1-128 Add-On Timer = 60ms</p>
 <p>Optional GS1-128 Add-On Timer = 70ms</p>	
	 <p>Optional GS1-128 Add-On Timer = 100ms</p>
 <p>Optional GS1-128 Add-On Timer = 120ms</p>	
	 <p>Optional GS1-128 Add-On Timer = 140ms</p>
 <p>Optional GS1-128 Add-On Timer = 160ms</p>	



Optional GS1-128 Add-On Timer — cont.



Optional GS1-128 Add-On Timer = 180ms

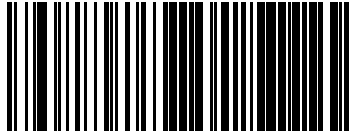

Optional GS1-128 Add-On Timer = 200ms

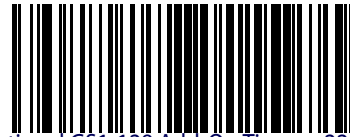

Optional GS1-128 Add-On Timer = 220ms

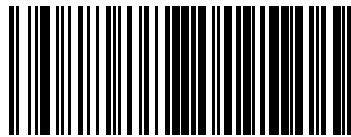

Optional GS1-128 Add-On Timer = 240ms

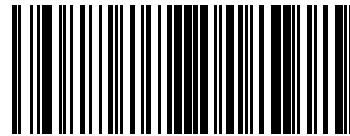

Optional GS1-128 Add-On Timer = 260ms

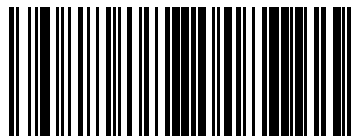

Optional GS1-128 Add-On Timer = 280ms

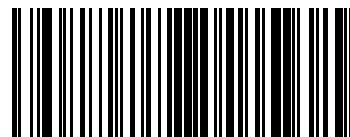

Optional GS1-128 Add-On Timer = 300ms



P2 Add-Ons Minimum Reads

This feature specifies the minimum number of times a P2 add-on must be read before it is marked as valid and then combined with a base label.

	 P2 Add-Ons Minimum Reads = 1
 P2 Add-Ons Minimum Reads = 2	
	 P2 Add-Ons Minimum Reads = 3
 P2 Add-Ons Minimum Reads = 4	



P5 Add-Ons Minimum Reads

This feature specifies the minimum number of times a P5 add-on must be read before it is marked as valid and then combined with a base label.

	 P5 Add-Ons Minimum Reads = 1
 P5 Add-Ons Minimum Reads = 2	
	 P5 Add-Ons Minimum Reads = 3
 P5 Add-Ons Minimum Reads = 4	



GS1-128 Add-Ons Minimum Reads

This feature specifies the minimum number of times an GS1-128 add-on must be read before it is marked as valid and then combined with a base label.

	 GS1-128 Add-Ons Minimum Reads = 1
 GS1-128 Add-Ons Minimum Reads = 2	
	 GS1-128 Add-Ons Minimum Reads = 3
 GS1-128 Add-Ons Minimum Reads = 4	

CODE 39

The following options apply to the Code 39 symbology.

Code 39 Enable/Disable

	 Code 39 = Disable
 Code 39 = Enable	

Code 39 Check Character Calculation

Enable this option to enables/disables calculation and verification of an optional Code 39 check character. When disabled, any check character in the label is treated as a data character

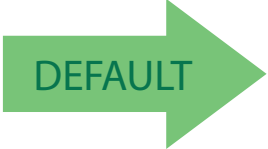
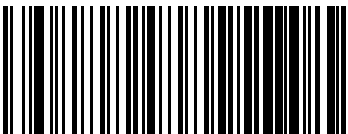
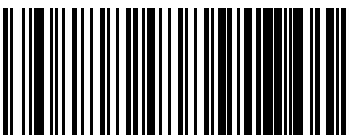
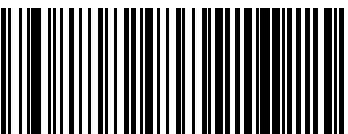
	 Code 39 Check Character Calculation = Don't Calculate
 Code 39 Check Character Calculation = Calculate Std Check	
	 Code 39 Check Character Calculation = Calculate Mod 7 Check



ENTER/EXIT PROGRAMMING MODE

Code 39 Check Character Transmission

Code 39 Check Character Calculation — cont.

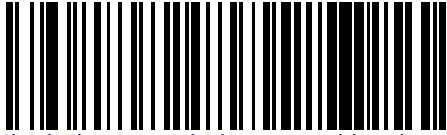

Code 39 Check Character Calculation = Enable Italian Post Check

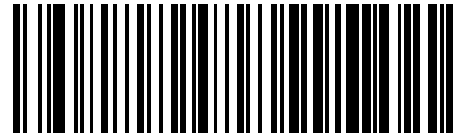

Code 39 Check Character Calculation = Enable Daimler
Chrysler Check

Code 39 Check Character Transmission

Enable this option to transmit the check character along with Code 39 barcode data.

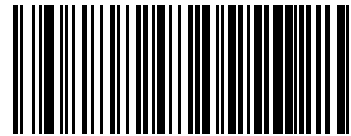

Code 39 Check Character Transmission = Don't Send



Code 39 Check Character Transmission = Send





Code 39 Start/Stop Character Transmission

Enable this option to enable/disable transmission of Code 39 start and stop characters.

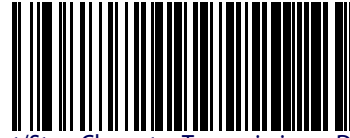
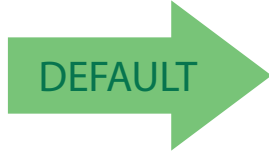

Code 39 Start/Stop Character Transmission = Don't Transmit

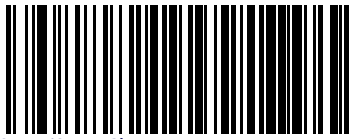

Code 39 Start/Stop Character Transmission = Transmit

Code 39 Full ASCII

Enables/disables the translation of Code 39 characters to Code 39 full-ASCII characters.

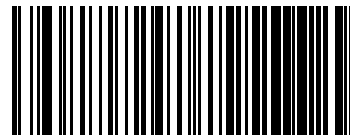
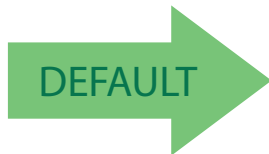

Code 39 Full ASCII = Disable

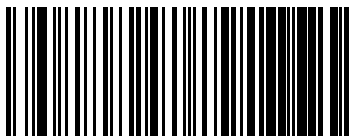



Code 39 Full ASCII = Enable



Code 39 Quiet Zones

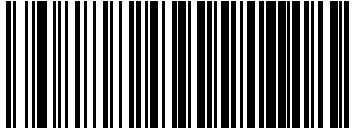
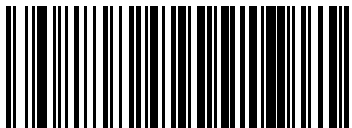
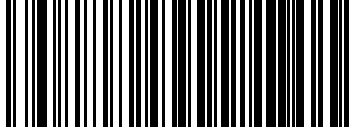

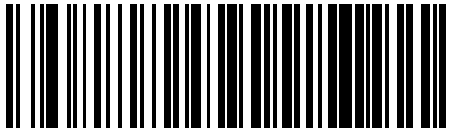
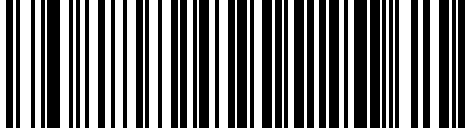
This feature specifies the number of quiet zones for Code 39 labels. Quiet zones are blank areas at the ends of a barcode, typically 10 times the width of the narrowest bar or space in the label.

 <p>Code 39 Quiet Zones = Quiet Zone on one side</p>	
	 <p>Code 39 Quiet Zones = Quiet Zones on two sides</p>
 <p>Code 39 Quiet Zones = Auto</p>	
	 <p>Code 39 Quiet Zones = Virtual Quiet Zones on two sides</p>
 <p>Code 39 Quiet Zones = Small Quiet Zones on two sides</p>	

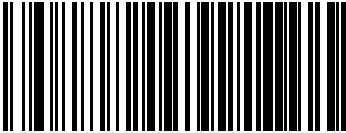
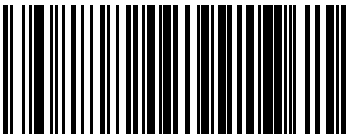

Code 39 Minimum Reads

This feature specifies the minimum number of consecutive times a Code 39 label must be decoded before it is accepted as good read.

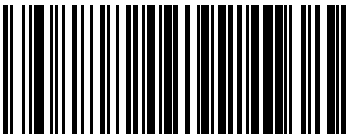
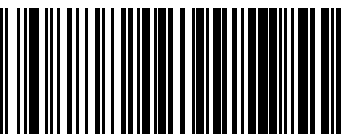
	 <p>Code 39 Minimum Reads = 1</p>
 <p>Code 39 Minimum Reads = 2</p>	
	 <p>Code 39 Minimum Reads = 3</p>
 <p>Code 39 Minimum Reads = 4</p>	



Code 39 Decoding Level

Decoding Levels are used to configure a barcode symbology decoder to be very aggressive to very conservative depending on a particular customer's needs. See [page 255](#) for more information on this feature.



This configuration item applies to Code 39 and Code 32.

 <p>Code 39 Decoding Level = 1 (Conservative)</p>	
	 <p>Code 39 Decoding Level = 2</p>
 <p>Code 39 Decoding Level = 3</p>	
	 <p>Code 39 Decoding Level = 4</p>
 <p>Code 39 Decoding Level = 5 (Aggressive)</p>	



Code 39 Length Control

This feature specifies either variable length decoding or fixed length decoding for the Code 39 symbology.

Variable Length. For variable length decoding, a minimum and maximum length may be set.

Fixed Length. For fixed length decoding, two different lengths may be set.

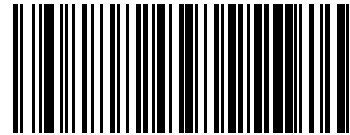
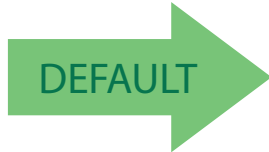

Code 39 Length Control = Variable Length

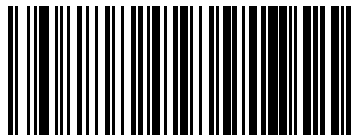

Code 39 Length Control = Fixed Length



Code 39 Set Length 1

This feature specifies one of the barcode lengths for [Code 39 Length Control](#). Length 1 is the minimum label length if in [Variable Length Mode](#), or the first fixed length if in [Fixed Length Mode](#). Length includes the barcode’s data characters only. The length can be set from 0 to 50 characters.

Table 2 provides examples for setting Length 1. See [page 256](#) for detailed instructions on setting this feature.

Table 2. Code 39 Length 1 Setting Examples

STEP	ACTION	EXAMPLES			
1	Desired Setting	00 Characters	07 Characters	15 Characters	50 Characters
2	Scan ENTER/EXIT PROGRAMMING MODE				
3	Scan SELECT CODE 39 LENGTH 1 SETTING				
4	Scan Two Characters From Appendix D, Keypad	'0' and '0'	'0' and '7'	'1' and '5'	'5' AND '0'
5	Scan ENTER/EXIT PROGRAMMING MODE				

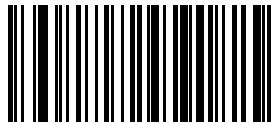

Select Code 39 Set Length 1 Setting

To configure this feature scan the ENTER/EXIT PROGRAMMING MODE barcode above, then the barcode at left, followed by the digits (in hex) from the Alphanumeric characters in [Appendix D, Keypad](#) representing your desired character(s). End by scanning the ENTER/EXIT barcode again.

Make a mistake? Scan the CANCEL barcode to abort and not save the entry string. You can then start again at the beginning.



CANCEL



02 = Length 1 is 2 Characters



Code 39 Set Length 2

This feature specifies one of the barcode lengths for [Code 39 Length Control](#). Length 2 is the maximum label length if in [Variable Length Mode](#), or the second fixed length if in [Fixed Length Mode](#). Length includes the barcode’s check, data, and full-ASCII shift characters. The length does not include start/stop characters.

Table 3 provides examples for setting Length 2. See [page 256](#) for detailed instructions on setting this feature.

Table 3. Code 39 Length 2 Setting Examples

STEP	ACTION	EXAMPLES			
1	Desired Setting	00 (Ignore This Length)	07 Characters	15 Characters	50 Characters
2	Scan ENTER/EXIT PROGRAMMING MODE				
3	Scan SELECT CODE 39 LENGTH 2 SETTING				
4	Scan Two Characters From Appendix D, Keypad	'0' and '0'	'0' and '7'	'1' and '5'	'5' AND '0'
5	Scan ENTER/EXIT PROGRAMMING MODE				

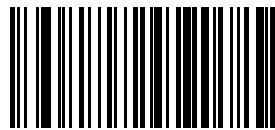

Select Code 39 Length 2 Setting

Make a mistake? Scan the CANCEL barcode to abort and not save the entry string. You can then start again at the beginning.

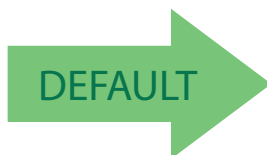

50 = Length 2 is 50 Characters



Code 39 Interdigit Ratio

This feature specifies the ratio between an intercharacter space and module for Code 39 labels.

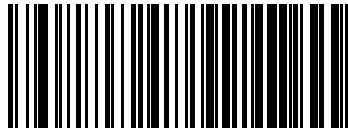
	 Code 39 Interdigit Ratio = Disable
 Code 39 Interdigit Ratio = 1	
	 Code 39 Interdigit Ratio = 2
 Code 39 Interdigit Ratio = 3	
	 Code 39 Interdigit Ratio = 4
 Code 39 Interdigit Ratio = 5	



Code 39

ENTER/EXIT PROGRAMMING MODE



Code 39 Interdigit Ratio — cont.

	 Code 39 Interdigit Ratio = 6
 Code 39 Interdigit Ratio = 7	
	 Code 39 Interdigit Ratio = 8
 Code 39 Interdigit Ratio = 9	
	 Code 39 Interdigit Ratio = 10



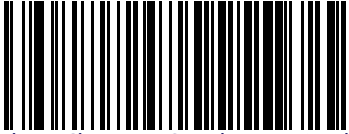

Code 39 Character Correlation

When correlation is enabled, the barcode reader will combine label data from multiple scans when decoding. Enabling correlation will help the scanner read labels that have some spots and/or voids. It may also help read labels that have damaged areas. Enabling correlation will also increase the chances that a label will be read incorrectly.

	 Code 39 Character Correlation = Disable
 Code 39 Character Correlation = Enable	

Code 39 Stitching

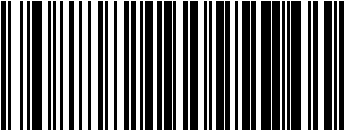
This option enables/disables stitching for Code 39 labels. When parts of a Code 39 barcode are presented to the reader with this feature enabled, the barcode parts will be assembled by the reader's software, and the data will be decoded if all barcode proofing requirements are met.

	 Code 39 Stitching = Disable
 Code 39 Stitching = Enable	





CODE 32 (ITAL PHARMACEUTICAL CODE)

The following options apply to the Code 32 (Italian Pharmaceutical Code) symbology.

Code 32 Enable/Disable

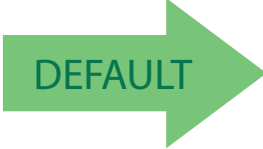
When disabled, the reader will not read Code 32 barcodes.

Code 32 Feature Setting Exceptions



The following features are set for Code 32 by using these Code 39 settings:

- "Code 39 Quiet Zones" on page 109
- "Code 39 Minimum Reads" on page 110
- "Code 39 Decoding Level" on page 111
- "Code 39 Interdigit Ratio" on page 115
- "Code 39 Character Correlation" on page 117
- "Code 39 Stitching" on page 117



Code 32 Check Char Transmission

Enable this option to transmit the check character along with Code 32 barcode data.

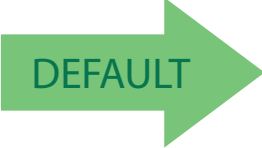
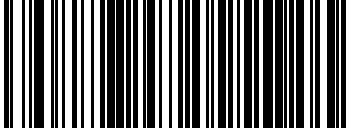
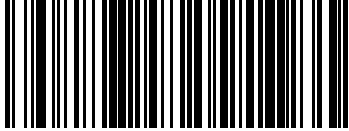
	 Code 32 Check Character Transmission = Don't Send
 Code 32 Check Character Transmission = Send	

Code 32 Start/Stop Character Transmission

This option enables/disables transmission of Code 32 start and stop characters.

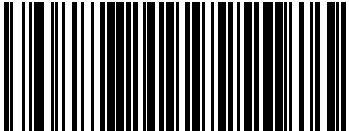
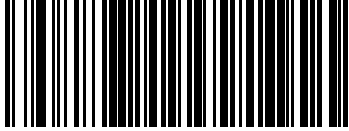
	 Code 32 Start/Stop Character Transmission = Don't Transmit
 Code 32 Start/Stop Character Transmission = Transmit	

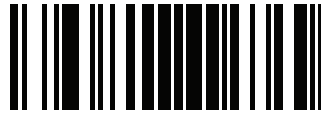

CODE 39 CIP (FRENCH PHARMACEUTICAL)

The following options apply to the Code 39 CIP symbology.

Code 39 CIP Enable/Disable

Enables/Disables ability of the reader to decode Code 39 CIP labels.

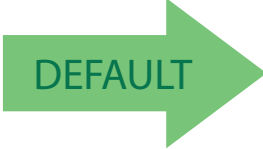
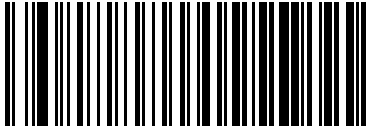
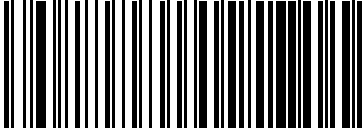
	 Code 39 CIP = Disable
 Code 39 CIP = Enable	





CODE 128

The following options apply to the Code 128 symbology.

Code 128 Enable/Disable

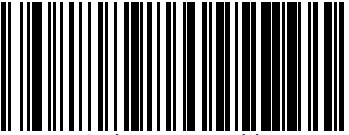
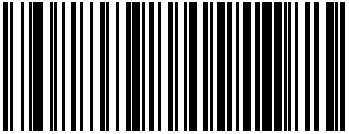
When disabled, the reader will not read Code 128 barcodes.

	 <p>Code 128 = Disable</p>
 <p>Code 128 = Enable</p>	

Expand Code 128 to Code 39

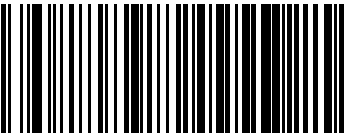
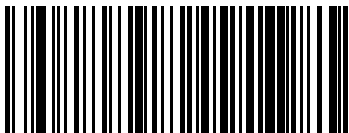

This feature enables/disables expansion of Code 128 labels to Code 39 labels.

	 <p>Code 128 to Code 39 = Don't Expand</p>
 <p>Code 128 to Code 39 = Expand</p>	

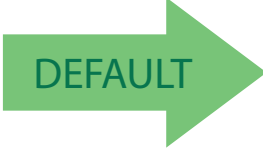
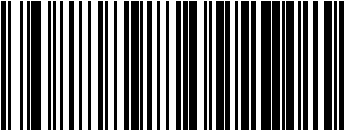

Code 128 Check Character Transmission

Enable this option to transmit the check character along with Code 128 barcode data.

	 Code 128 Check Character Transmission = Don't Send
 Code 128 Check Character Transmission = Send	

Code 128 Function Character Transmission

Enables/disables transmission of Code128 function characters 1, 2, 3, and 4.

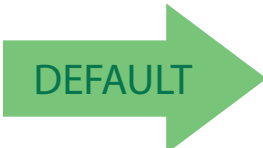
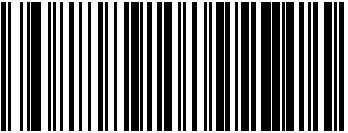
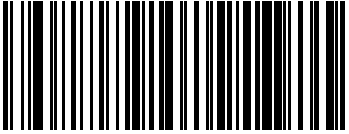
	 Code 128 Function Character Transmission = Don't Send
 Code 128 Function Character Transmission = Send	





ENTER/EXIT PROGRAMMING MODE

Code 128 Sub-Code Change Transmission

Code 128 Sub-Code Change Transmission

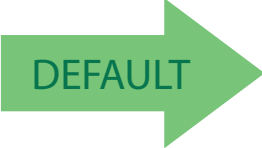
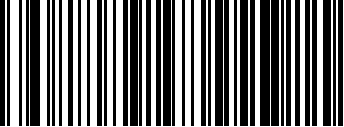
Enables/disables the transmission of “Sub-Code exchange” characters (NOT transmitted by standard decoding).

	 Code 128 Sub-Code Change Transmission = Disable
 Code 128 Sub-Code Change Transmission = Enable	

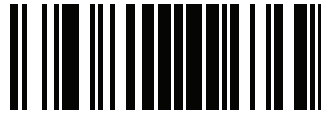

Code 128 Quiet Zones

This feature specifies the number of quiet zones for Code 128 labels. Quiet zones are blank areas at the ends of a barcode and are typically 10 times the width of the narrowest bar or space in the label.

	 <p>Code 128 Quiet Zones = No Quiet Zones</p>
 <p>Code 128 Quiet Zones = Quiet Zone on one side</p>	
	 <p>Code 128 Quiet Zones = Quiet Zones on two sides</p>
 <p>Code 128 Quiet Zones = Auto</p>	
	 <p>Code 128 Quiet Zones = Virtual Quiet Zones on two sides</p>



Code 128 Minimum Reads



This feature specifies the minimum number of consecutive times a Code 128 label must be decoded before it is accepted as good read.

	 Code 128 Minimum Reads = 1
 Code 128 Minimum Reads = 2	
	 Code 128 Minimum Reads = 3
 Code 128 Minimum Reads = 4	

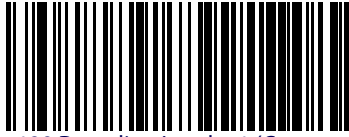
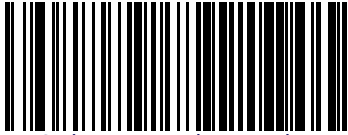
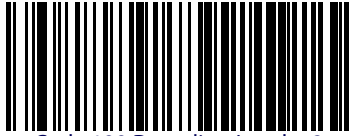

Code 128 Decoding Level

Decoding Levels are used to configure a barcode symbology decoder to be very aggressive to very conservative depending on a particular customer's needs. See [page 255](#) for more information on this feature.

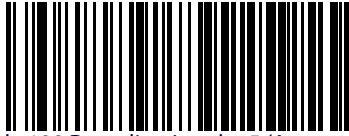
 <p>Code 128 Decoding Level = 1 (Conservative)</p>	
	 <p>Code 128 Decoding Level = 2</p>
 <p>Code 128 Decoding Level = 3</p>	
	 <p>Code 128 Decoding Level = 4</p>
 <p>Code 128 Decoding Level = 5 (Aggressive)</p>	



ENTER/EXIT PROGRAMMING MODE

Code 128 Length Control

Code 128 Length Control

This feature specifies either variable length decoding or fixed length decoding for the Code 128 symbology. See [page 256](#) for more information.

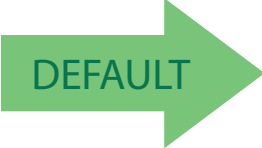
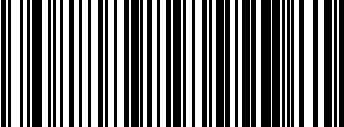
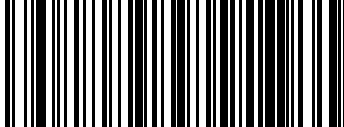
	 Code 128 Length Control = Variable Length
 Code 128 Length Control = Fixed Length	



Code 128 Set Length 1

Specifies one of the barcode lengths for [Code 128 Length Control](#). Length 1 is the minimum label length if in [Variable Length Mode](#), or the first fixed length if in [Fixed Length Mode](#). Length includes the barcode’s data characters only. The length can be set from 1 to 80 characters.

Table 4 provides some examples for setting Length 1. See [page 256](#) for detailed instructions on setting this feature.

Table 4. Code 128 Length 1 Setting Examples

STEP	ACTION	EXAMPLES			
1	Desired Setting	01 Character	07 Characters	15 Characters	80 Characters
2	Scan ENTER/EXIT PROGRAMMING MODE				
3	Scan SELECT CODE 128 LENGTH 1 SETTING				
4	Scan Two Characters From Appendix D, Keypad	'0' and '1'	'0' and '7'	'1' and '5'	'8' AND '0'
5	Scan ENTER/EXIT PROGRAMMING MODE				

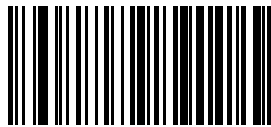

Select Code 128 Set Length 1 Setting

Make a mistake? Scan the CANCEL barcode to abort and not save the entry string. You can then start again at the beginning.

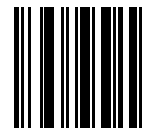

CANCEL

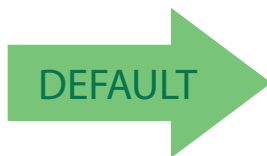

01 = Length 1 is 1 Character



Code 128 Set Length 2

This feature specifies one of the barcode lengths for [Code 128 Length Control](#). Length 2 is the maximum label length if in [Variable Length Mode](#), or the second fixed length if in [Fixed Length Mode](#). Length includes the barcode’s data characters only.

The length can be set from 1 to 80 characters. A setting of 0 specifies to ignore this length (only one fixed length).

Table 5 provides examples for setting Length 2. See [page 256](#) for detailed instructions on setting this feature.

Table 5. Code 128 Length 2 Setting Examples

STEP	ACTION	EXAMPLES			
1	Desired Setting	00 (Ignore This Length)	07 Characters	15 Characters	80 Characters
2	Scan ENTER/EXIT PROGRAMMING MODE				
3	Scan SELECT CODE 128 LENGTH 2 SETTING				
4	Scan Two Characters From Appendix D, Keypad	'0' and '0'	'0' and '7'	'0' and 'F'	'5' AND '0'
5	Scan ENTER/EXIT PROGRAMMING MODE				

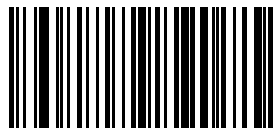

Select Code 128 Length 2 Setting

Make a mistake? Scan the CANCEL barcode to abort and not save the entry string. You can then start again at the beginning.

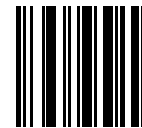

CANCEL

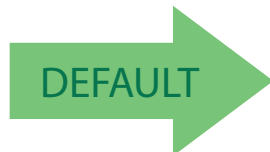



80 = Length 2 is 80 Characters

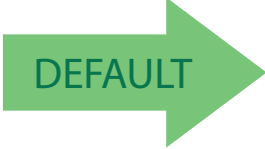
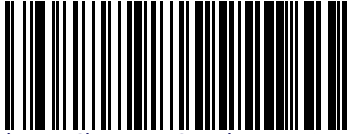

Code 128 Character Correlation

When correlation is enabled, the barcode reader will combine label data from multiple scans when decoding. Enabling correlation will help the scanner read labels that have some spots and/or voids. It may also help read labels that have damaged areas. Enabling correlation will also increase the chances that a label will be read incorrectly.

	 Code 128 Character Correlation = Disable
 Code 128 Character Correlation = Enable	

Code 128 Stitching

This option enables/disables stitching for Code 128 labels. When parts of a Code 128 barcode are presented to the reader with this feature enabled, the barcode parts will be assembled by the reader's software, and the data will be decoded if all barcode proofing requirements are met.

	 Code 128 Stitching = Disable
 Code 128 Stitching = Enable	



GS1-128

The following options apply to the GS1-128 symbology. (Also known as USS-128, GS1-128, GTIN-128, UCC-128, EAN-128.)

GS1-128 Enable

This option enables/disables the ability of the reader to translate GS1-128 labels to the GS1-128 data format. Options are:

- Transmit GS1-128 labels in Code 128 data format.
- Transmit GS1-128 labels in GS1-128 data format.
- Do not transmit GS1-128 labels.

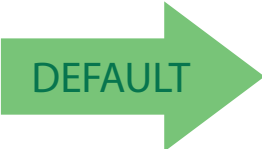
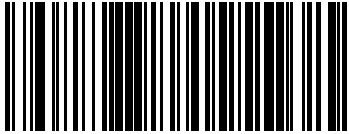
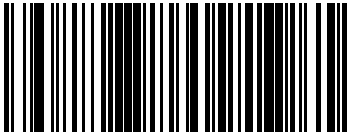
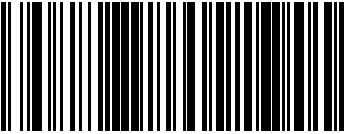
	 GS1-128 = Transmit in Code 128 data format
 GS1-128 = Transmit in GS1-128 data format	
	 GS1-128 = Do not transmit GS1-128 labels

CODE ISBT 128

The following options apply to the ISBT 128 symbology.

ISBT 128 Concatenation

Use this option to enable/disable ISBT128 concatenation of 2 labels.

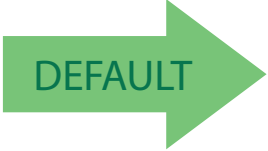
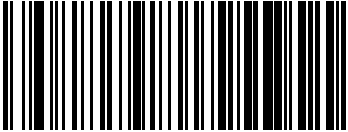
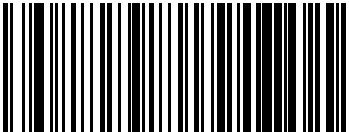
	 ISBN 128 Concatenation = Disable
 ISBN 128 Concatenation = Enable	

ISBT 128 Concatenation Mode

Specifies the concatenation mode between Static and Dynamic.

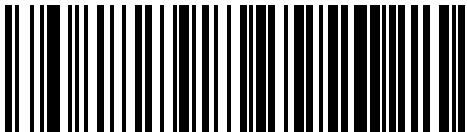
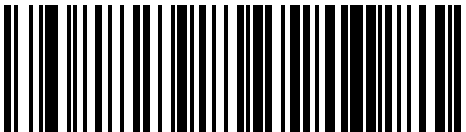

This option is only valid when ISBT 128 Concatenation is enabled (see page 132).

	 ISBN 128 Concatenation Mode = Static
 ISBN 128 Concatenation Mode = Dynamic	



ENTER/EXIT PROGRAMMING MODE

ISBT 128 Dynamic Concatenation Timeout

ISBT 128 Dynamic Concatenation Timeout

Specifies the timeout used by the ISBT 128 Dynamic Concatenation Mode.

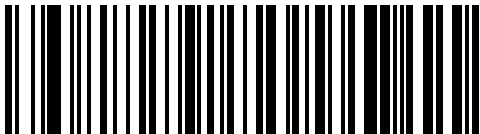
	 ISBT 128 Dynamic Concatenation Timeout = 50 msec
 ISBT 128 Dynamic Concatenation Timeout = 100 msec	
	 ISBT 128 Dynamic Concatenation Timeout = 200 msec
 ISBT 128 Dynamic Concatenation Timeout = 500 msec	
	 ISBT 128 Dynamic Concatenation Timeout = 750 msec
 ISBT 128 Dynamic Concatenation Timeout = 1 second	

ISBT 128 Advanced Concatenation Options



To set up pairs of label types for concatenation, use the Datalogic Aladdin configuration application or contact Datalogic Technical Support, as described on [page 8](#).





INTERLEAVED 2 OF 5 (I 2 OF 5)

The following options apply to the I 2 of 5 symbology.

I 2 of 5 Enable/Disable

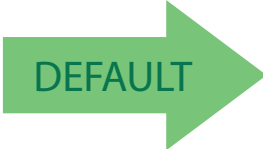
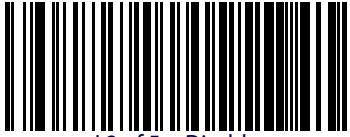
When disabled, the reader will not read I 2 of 5 barcodes.

I 2 of 5 Check Character Calculation

This option enables/disables calculation and verification of an optional I 2 of 5 check character.

	
	
	

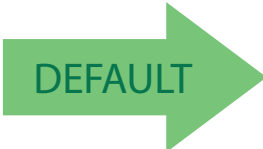
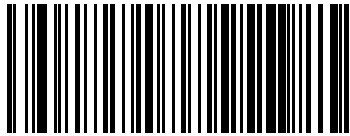
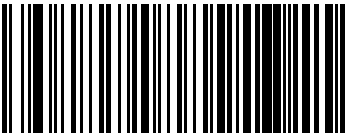
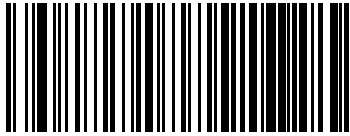

ENTER/EXIT PROGRAMMING MODE

I 2 of 5 Check Character Transmission

I 2 of 5 Check Character Calculation - cont.

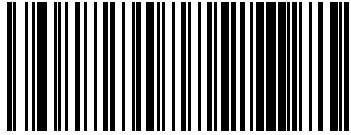

I 2 of 5 Check Character Calculation = Check DHL

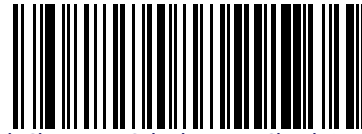

I 2 of 5 Check Character Calculation = Check Daimler Chrysler

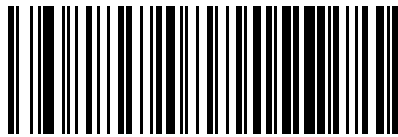

I 2 of 5 Check Character Calculation = Check Bosch

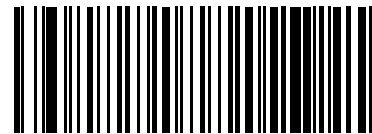

I 2 of 5 Check Character Calculation = Italian Post

I 2 of 5 Check Character Transmission

Enable this option to transmit the check character along with I 2 of 5 barcode data.

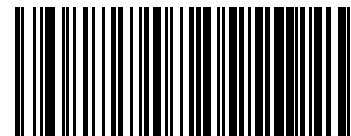

I 2 of 5 Check Character Transmission = Don't Send

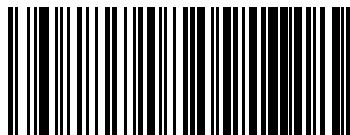



I 2 of 5 Check Character Transmission = Send



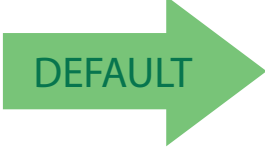

I 2 of 5 Minimum Reads

This feature specifies the minimum number of consecutive times an I 2 of 5 label must be decoded before it is accepted as good read.

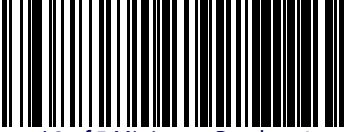
	 I 2 of 5 Minimum Reads = 1
 I 2 of 5 Minimum Reads = 2	
	 I 2 of 5 Minimum Reads = 3
 I 2 of 5 Minimum Reads = 4	



2 of 5 Decoding Level



This configuration item applies to Interleaved 2 of 5, Datalogic 2 of 5 and Standard 2 of 5.

Decoding Levels are used to configure a barcode symbology decoder to be very aggressive to very conservative depending on a particular customer's needs. See [page 255](#) for more information on this feature.

 2 of 5 Decoding Level = 1 (Conservative)	
	 2 of 5 Decoding Level = 2
 2 of 5 Decoding Level = 3	
	 2 of 5 Decoding Level = 4
 2 of 5 Decoding Level = 5 (Aggressive)	



Interleaved 2 of 5 (I 2 of 5)

ENTER/EXIT PROGRAMMING MODE

I 2 of 5 Length Control

This feature specifies either variable length decoding or fixed length decoding for the I 2 of 5 symbology.

Variable Length. For variable length decoding, a minimum and maximum length may be set.

Fixed Length. For fixed length decoding, two different lengths may be set.

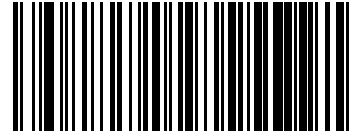
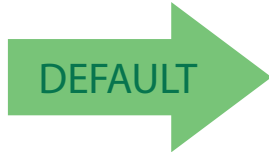

I 2 of 5 Length Control = Variable Length

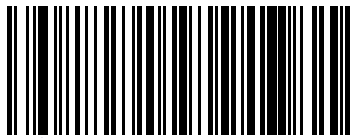

I 2 of 5 Length Control = Fixed Length



I 2 of 5 Set Length 1

This feature specifies one of the barcode lengths for I 2 of 5 Length Control. Length 1 is the minimum label length if in Variable Length Mode, or the first fixed length if in Fixed Length Mode. The length includes the barcode's check and data characters. The length can be set from 2 to 50 characters in increments of two.

Table 6 provides some examples for setting Length 1. See page 256 for detailed instructions on setting this feature.

Table 6. I 2 of 5 Length 1 Setting Examples

STEP	ACTION	EXAMPLES			
1	Desired Setting	2 Characters	6 Characters	14 Characters	50 Characters
2	Pad with leading zeroes to yield two digits	02	06	14	50
3	Scan ENTER/EXIT PROGRAMMING MODE				
4	Scan SELECT I 2 of 5 LENGTH 1 SETTING				
5	Scan Two Characters From Appendix D, Keypad	'0' and '2'	'0' and '6'	'1' and '4'	'5' AND '0'
6	Scan ENTER/EXIT PROGRAMMING MODE				

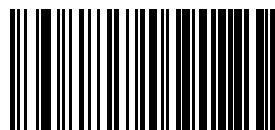

Select I 2 of 5 Length 1 Setting

Make a mistake? Scan the CANCEL barcode to abort and not save the entry string. You can then start again at the beginning.

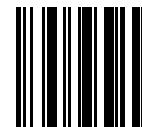

CANCEL

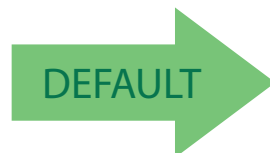

06 = Length 1 is 6 Characters



I 2 of 5 Set Length 2

This feature specifies one of the barcode lengths for **I 2 of 5 Length Control**. Length 2 is the maximum label length if in **Variable Length Mode**, or the second fixed length if in **Fixed Length Mode**. The length includes the barcode's check and data characters.

The length can be set from 2 to 50 characters. A setting of 0 specifies to ignore this length (only one fixed length).

Table 7 provides examples for setting Length 2. See [page 256](#) for detailed instructions on setting this feature.

Table 7. I 2 of 5 Length 2 Setting Examples

STEP	ACTION	EXAMPLES			
1	Desired Setting	Ignore This Length	4 Characters	14 Characters	50 Characters
2	Pad with leading zeroes to yield two digits	00	04	14	50
3	Scan ENTER/EXIT PROGRAMMING MODE				
4	Scan SELECT I 2 OF 5 LENGTH 2 SETTING				
5	Scan Two Characters From Appendix D, Keypad	'0' and '0'	'0' and '4'	'1' and '4'	'5' AND '0'
6	Scan ENTER/EXIT PROGRAMMING MODE				

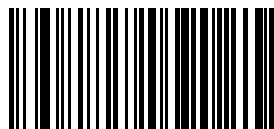

Select I 2 of 5 Length 2 Setting

Make a mistake? Scan the CANCEL barcode to abort and not save the entry string. You can then start again at the beginning.

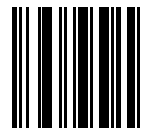

CANCEL

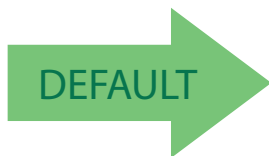

50 = Length 2 is 50 Characters



I 2 of 5 Character Correlation

When correlation is enabled, the barcode reader will combine label data from multiple scans when decoding. Enabling correlation will help the scanner read labels that have some spots and/or voids. It may also help read labels that have damaged areas. Enabling correlation will also increase the chances that a label will be read incorrectly.

	 I 2 of 5 Character Correlation = Disable
 I 2 of 5 Character Correlation = Enable	

I 2 of 5 Stitching

This option enables/disables stitching for I 2 of 5 labels. When parts of a I 2 of 5 barcode are presented to the reader with this feature enabled, the barcode parts will be assembled by the reader's software, and the data will be decoded if all barcode proofing requirements are met.

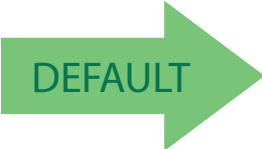
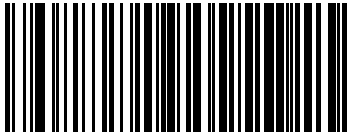
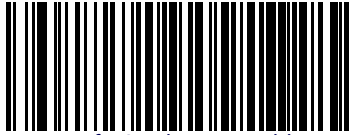
	 I 2 of 5 Stitching = Disable
 I 2 of 5 Stitching = Enable	



STANDARD 2 OF 5

The following options apply to the Standard 2 of 5 symbology.

Standard 2 of 5 Enable/Disable

When disabled, the reader will not read Standard 2 of 5 barcodes.

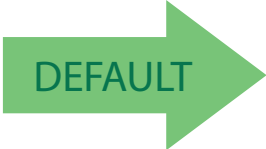
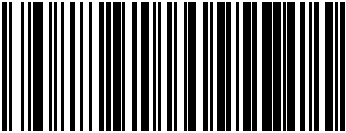
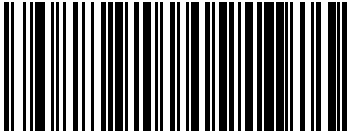
	 Standard 2 of 5 = Disable
 Standard 2 of 5 = Enable	

Standard 2 of 5 Check Character Calculation

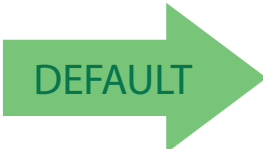
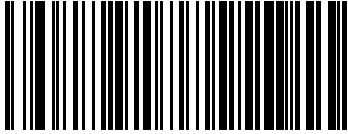
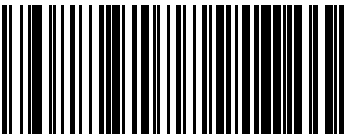

This option enables/disables calculation and verification of an optional Standard 2 of 5 check character.

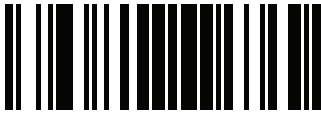
	 Standard 2 of 5 Check Character Calculation = Disable
 Standard 2 of 5 Check Character Calculation = Enable	

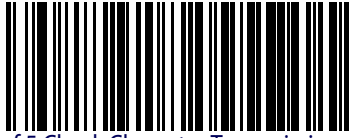

Standard 2 of 5 Check Character Transmission

This feature enables/disables transmission of an optional Standard 2 of 5 check character.

	 <p>Standard 2 of 5 Check Character Transmission = Don't Send</p>
 <p>Standard 2 of 5 Check Character Transmission = Send</p>	

Standard 2 of 5 Minimum Reads

This feature specifies the minimum number of consecutive times a Standard 2 of 5 label must be decoded before it is accepted as good read.

	 <p>Standard 2 of 5 Minimum Reads = 1</p>
 <p>Standard 2 of 5 Minimum Reads = 2</p>	
	 <p>Standard 2 of 5 Minimum Reads = 3</p>
 <p>Standard 2 of 5 Minimum Reads = 4</p>	

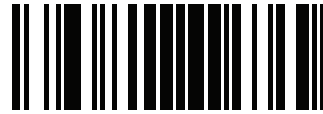

Standard 2 of 5 Decoding Level



The Standard 2 of 5 Decoding Level feature is set using "2 of 5 Decoding Level" on page 137.

Standard 2 of 5 Length Control

This feature specifies either variable length decoding or fixed length decoding for the Standard 2 of 5 symbology.

Variable Length. For variable length decoding, a minimum and maximum length may be set.

Fixed Length. For fixed length decoding, two different lengths may be set.

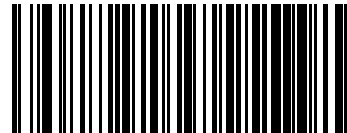
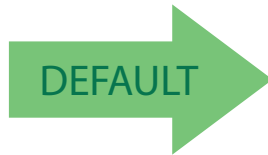

Standard 2 of 5 Length Control = Variable Length

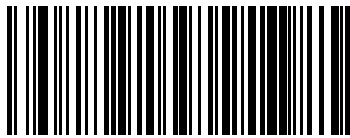

Standard 2 of 5 Length Control = Fixed Length



Standard 2 of 5 Set Length 1

This feature specifies one of the barcode lengths for [Standard 2 of 5 Length Control](#). Length 1 is the minimum label length if in [Variable Length Mode](#), or the first fixed length if in [Fixed Length Mode](#). Length includes the barcode’s check and data characters. The length can be set from 1 to 50 characters.

Table 8 provides some examples for setting Length 1. See [page 256](#) if you want detailed instructions on setting this feature.

Table 8. Standard 2 of 5 Length 1 Setting Examples

STEP	ACTION	EXAMPLES			
1	Desired Setting	01 Character	07 Characters	15 Characters	50 Characters
2	Scan ENTER/EXIT PROGRAMMING MODE				
3	Scan SELECT STANDARD 2 OF 5 LENGTH 1 SETTING				
4	Scan Two Characters From Appendix D, Keypad	'0' and '1'	'0' and '7'	'1' and '5'	'5' AND '0'
5	Scan ENTER/EXIT PROGRAMMING MODE				

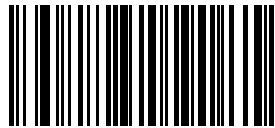

Select Standard 2 of 5 Length 1 Setting

Make a mistake? Scan the CANCEL barcode to abort and not save the entry string. You can then start again at the beginning.

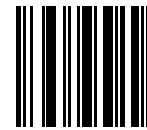

CANCEL

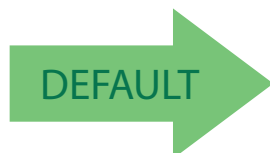

08 = Length 1 is 8 Characters



Standard 2 of 5 Set Length 2

This feature specifies one of the barcode lengths for [Standard 2 of 5 Length Control](#). Length 2 is the maximum label length if in [Variable Length](#) Mode, or the second fixed length if in [Fixed Length](#) Mode. Length includes the barcode's check and data characters.

The length can be set from 1 to 50 characters. A setting of 0 specifies to ignore this length (only one fixed length).

Table 9 provides examples for setting Length 2. See [page 256](#) for detailed instructions on setting this feature.

Table 9. Standard 2 of 5 Length 2 Setting Examples

STEP	ACTION	EXAMPLES			
1	Desired Setting (pad with leading zeroes)	00 (Ignore This Length)	07 Characters	15 Characters	50 Characters
2	Scan ENTER/EXIT PROGRAMMING MODE				
3	Scan SELECT STANDARD 2 OF 5 LENGTH 2 SETTING				
4	Scan Two Characters From Appendix D, Keypad	'0' and '0'	'0' and '7'	'1' and '5'	'5' AND '0'
5	Scan ENTER/EXIT PROGRAMMING MODE				

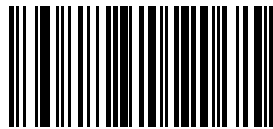

Select Standard 2 of 5 Length 2 Setting

Make a mistake? Scan the CANCEL barcode to abort and not save the entry string. You can then start again at the beginning.

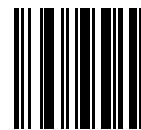

CANCEL

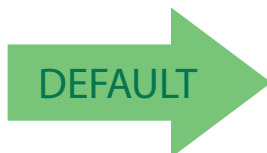



50 = Length 2 is 50 Characters

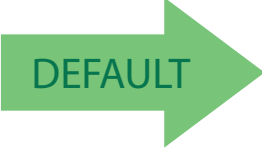
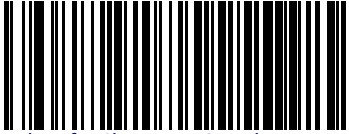

Standard 2 of 5 Character Correlation

When correlation is enabled, the barcode reader will combine label data from multiple scans when decoding. Enabling correlation will help the scanner read labels that have some spots and/or voids. It may also help read labels that have damaged areas. Enabling correlation will also increase the chances that a label will be read incorrectly.

	 Standard 2 of 5 Character Correlation = Disable
 Standard 2 of 5 Character Correlation = Enable	

Standard 2 of 5 Stitching

This option enables/disables stitching for Standard 2 of 5 labels. When parts of a Standard 2 of 5 barcode are presented to the reader with this feature enabled, the barcode parts will be assembled by the reader's software, and the data will be decoded if all barcode proofing requirements are met.

	 Standard 2 of 5 Stitching = Disable
 Standard 2 of 5 Stitching = Enable	



INDUSTRIAL 2 OF 5

The following options apply to the Industrial 2 of 5 symbology.



Industrial 2 of 5 Enable/Disable

Enables/Disables ability of reader to decode Industrial 2 of 5 labels.

Industrial 2 of 5 Check Character Calculation

Enables/Disables calculation and verification of an optional Industrial 2 of 5 check character.





ENTER/EXIT PROGRAMMING MODE

Industrial 2 of 5 Check Character Transmission

Industrial 2 of 5 Check Character Transmission

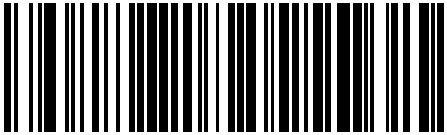
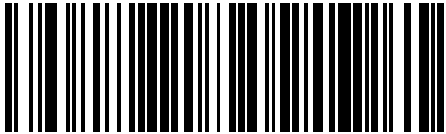
Enables/disables transmission of an Industrial 2 of 5 check character.

	 <p>Industrial 2 of 5 Check Character Transmission = Disable</p>
 <p>Industrial 2 of 5 Check Character Transmission = Enable</p>	

Industrial 2 of 5 Length Control

This feature specifies either variable length decoding or fixed length decoding for the Industrial 2 of 5 symbology.

Variable Length. For variable length decoding, a minimum and maximum length may be set.

Fixed Length. For fixed length decoding, two different lengths may be set.

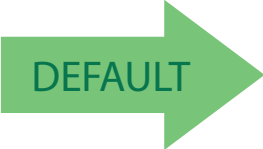
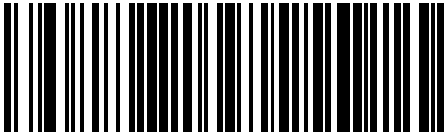
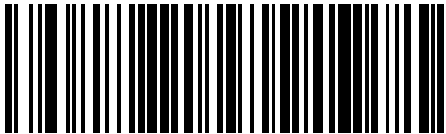
	 <p>Industrial 2 of 5 Length Control = Variable Length</p>
 <p>Industrial 2 of 5 = Fixed Length</p>	



Industrial 2 of 5 Set Length 1

This feature specifies one of the barcode lengths for **Industrial 2 of 5 Length Control**. Length 1 is the minimum label length if in **Variable Length Mode**, or the first fixed length if in **Fixed Length Mode**. Length includes the barcode's data characters only. The length can be set from 0 to 50 characters.

Table 10 provides some examples for setting Length 1. See [page 256](#) if you want detailed instructions on setting this feature.

Table 10. Industrial 2 of 5 Length 1 Setting Examples

STEP	ACTION	EXAMPLES			
1	Desired Setting	00 Characters	07 Characters	15 Characters	50 Characters
2	Scan ENTER/EXIT PROGRAMMING MODE				
3	Scan SELECT INDUSTRIAL 2 OF 5 LENGTH 1 SETTING				
4	Scan Two Characters From Appendix D, Keypad	'0' and '0'	'0' and '7'	'1' and '5'	'5' AND '0'
5	Scan ENTER/EXIT PROGRAMMING MODE				

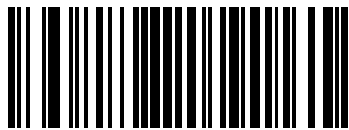

Select Industrial 2 of 5 Set Length 1 Setting

Make a mistake? Scan the CANCEL barcode to abort and not save the entry string. You can then start again at the beginning.



CANCEL

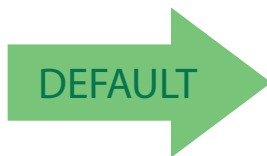

01 = Length 1 is 1 Character



Industrial 2 of 5 Set Length 2

This feature specifies one of the barcode lengths for **Industrial 2 of 5 Length Control**. Length 2 is the maximum label length if in **Variable Length Mode**, or the second fixed length if in **Fixed Length Mode**. Length includes the barcode’s check, data, and full-ASCII shift characters. The length does not include start/stop characters.

The length can be set from 1 to 50 characters. A setting of 0 specifies to ignore this length (only one fixed length).

Table 11 provides examples for setting Length 2. See [page 256](#) for detailed instructions on setting this feature.

Table 11. Industrial 2 of 5 Length 2 Setting Examples

STEP	ACTION	EXAMPLES			
1	Desired Setting	00 (Ignore This Length)	07 Characters	15 Characters	50 Characters
2	Scan ENTER/EXIT PROGRAMMING MODE				
3	Scan SELECT INDUSTRIAL 2 OF 5 LENGTH 2 SETTING				
4	Scan Two Characters From Appendix D, Keypad	'0' and '0'	'0' and '7'	'1' and '5'	'5' AND '0'
5	Scan ENTER/EXIT PROGRAMMING MODE				

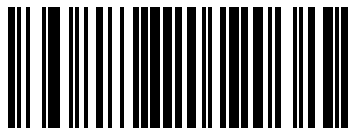

Select Industrial 2 of 5 Length 2 Setting

Make a mistake? Scan the CANCEL barcode to abort and not save the entry string. You can then start again at the beginning.



CANCEL

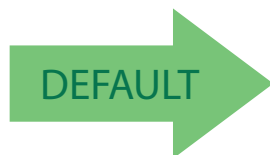

50 = Length 2 is 50 Characters



Industrial 2 of 5 Minimum Reads

This feature specifies the minimum number of consecutive times an Industrial 2 of 5 label must be decoded before it is accepted as good read.

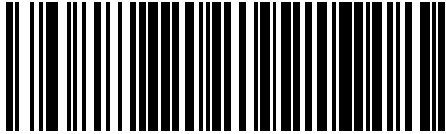
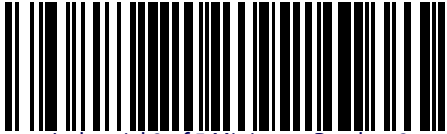
	 <p>Industrial 2 of 5 Minimum Reads = 1</p>
 <p>Industrial 2 of 5 Minimum Reads = 2</p>	
	 <p>Industrial 2 of 5 Minimum Reads = 3</p>
 <p>Industrial 2 of 5 Minimum Reads = 4</p>	

Industrial 2 of 5 Character Correlation

Enable/disables character correlation for Industrial 2 of 5.

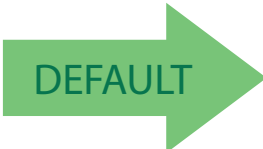
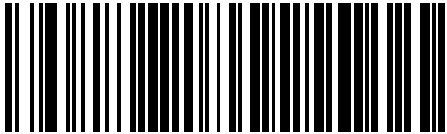
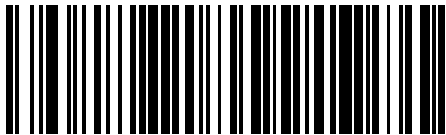
	 <p>Industrial 2 of 5 Character Correlation = Disable</p>
 <p>Industrial 2 of 5 Character Correlation = Enable</p>	





ENTER/EXIT PROGRAMMING MODE

Industrial 2 of 5 Stitching

Industrial 2 of 5 Stitching

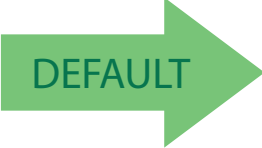
Enables/disables fixed length stitching for Industrial 2 of 5.

	 <p>Industrial 2 of 5 Stitching = Disable</p>
 <p>Industrial 2 of 5 Stitching = Enable</p>	

CODE IATA

The following options apply to the IATA symbology.



IATA Enable/Disable

Enables/Disables the ability of the reader to decode IATA labels.

	 <p>IATA = Disable</p>
 <p>IATA = Enable</p>	

IATA Check Character Transmission

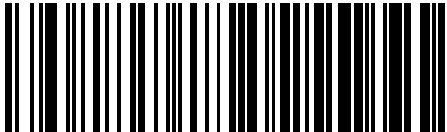
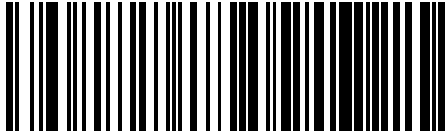
Enables/Disables calculation and verification of an optional Industrial 2 of 5 check character.

	 <p>IATA Check Character Transmission = Disable</p>
 <p>IATA Check Character Transmission = Enable</p>	



DATALOGIC 2 OF 5

The following options apply to the Datalogic 2 of 5 symbology.

Datalogic 2 of 5 Enable/Disable

When disabled, the reader will not read Datalogic 2 of 5 barcodes.

	 <p>Datalogic 2 of 5 = Disable</p>
 <p>Datalogic 2 of 5 = Enable</p>	

Datalogic 2 of 5 Check Character Calculation

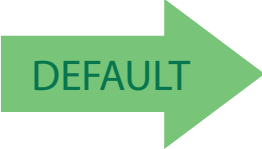
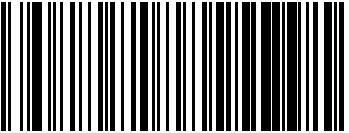
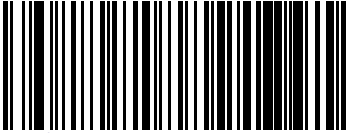

This option enables/disables calculation and verification of an optional Datalogic 2 of 5 check character.

	 <p>Datalogic 2 of 5 Check Character Calculation = Disable</p>
 <p>Datalogic 2 of 5 Check Character Calculation = Enable</p>	

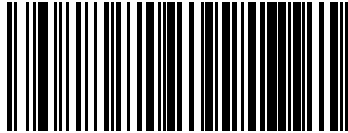
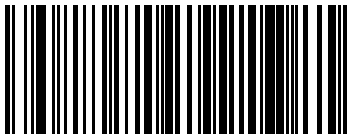

Datalogic 2 of 5 Minimum Reads

This feature specifies the minimum number of consecutive times an Datalogic 2 of 5 label must be decoded before it is accepted as good read.

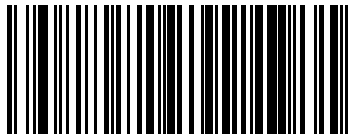
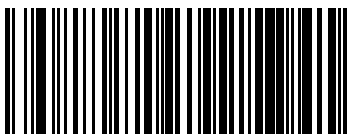
	 1 2 of 5 Minimum Reads = 1
 1 2 of 5 Minimum Reads = 2	
	 1 2 of 5 Minimum Reads = 3
 1 2 of 5 Minimum Reads = 4	

Datalogic 2 of 5 Decoding Level



The Datalogic 2 of 5 Decoding Level feature is set using "2 of 5 Decoding Level" on page 137.



Datalogic 2 of 5 Length Control

This feature specifies either variable length decoding or fixed length decoding for the Datalogic 2 of 5 symbology.

Variable Length. For variable length decoding, a minimum and maximum length may be set.

Fixed Length. For fixed length decoding, two different lengths may be set.

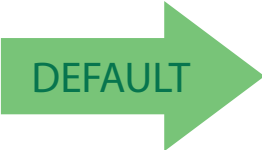
	 <p>Datalogic 2 of 5 Length Control = Variable Length</p>
 <p>Datalogic 2 of 5 Length Control = Fixed Length</p>	



Datalogic 2 of 5 Set Length 1

This feature specifies one of the barcode lengths for [Datalogic 2 of 5 Length Control](#). Length 1 is the minimum label length if in [Variable Length](#) Mode, or the first fixed length if in [Fixed Length](#) Mode. The length includes the barcode’s check and data characters. The length can be set from 2 to 50 characters in increments of two.

Table 12 provides some examples for setting Length 1. See [page 256](#) for detailed instructions on setting this feature.

Table 12. Datalogic 2 of 5 Length 1 Setting Examples

STEP	ACTION	EXAMPLES			
1	Desired Setting	2 Characters	6 Characters	14 Characters	50 Characters
2	Pad with leading zeroes to yield two digits	02	06	14	50
3	Scan ENTER/EXIT PROGRAMMING MODE				
4	Scan SELECT Datalogic 2 of 5 LENGTH 1 SETTING				
5	Scan Two Characters From Appendix D, Keypad	'0' and '2'	'0' and '6'	'1' and '4'	'5' AND '0'
6	Scan ENTER/EXIT PROGRAMMING MODE				

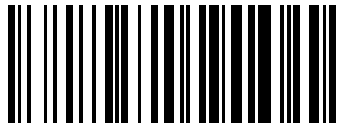

Select Datalogic 2 of 5 Length 1 Setting

Make a mistake? Scan the CANCEL barcode to abort and not save the entry string. You can then start again at the beginning.

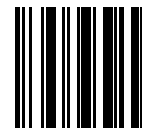

CANCEL

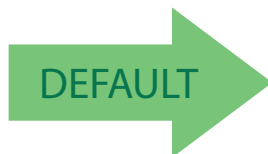

06 = Length 1 is 6 Characters



Datalogic 2 of 5 Set Length 2

This feature specifies one of the barcode lengths for [Datalogic 2 of 5 Length Control](#). Length 2 is the maximum label length if in [Variable Length Mode](#), or the second fixed length if in [Fixed Length Mode](#). The length includes the barcode’s check and data characters.

The length can be set from 2 to 50 characters. A setting of 0 specifies to ignore this length (only one fixed length).

Table 13 provides examples for setting Length 2. See [page 256](#) for detailed instructions on setting this feature.

Table 13. Datalogic 2 of 5 Length 2 Setting Examples

STEP	ACTION	EXAMPLES			
1	Desired Setting	Ignore This Length	4 Characters	14 Characters	50 Characters
2	Pad with leading zeroes to yield two digits	00	04	14	50
3	Scan ENTER/EXIT PROGRAMMING MODE				
4	Scan SELECT DATALOGIC 2 OF 5 LENGTH 2 SETTING				
5	Scan Two Characters From Appendix D, Keypad	'0' and '0'	'0' and '4'	'1' and '4'	'5' AND '0'
6	Scan ENTER/EXIT PROGRAMMING MODE				

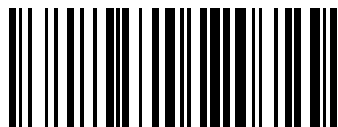

Select Datalogic 2 of 5 Length 2 Setting

Make a mistake? Scan the CANCEL barcode to abort and not save the entry string. You can then start again at the beginning.

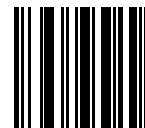

CANCEL

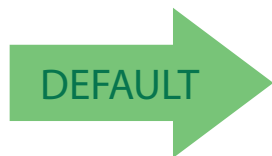

50 = Length 2 is 50 Characters



Datalogic 2 of 5 Character Correlation

When correlation is enabled, the barcode reader will combine label data from multiple scans when decoding. Enabling correlation will help the scanner read labels that have some spots and/or voids. It may also help read labels that have damaged areas. Enabling correlation will also increase the chances that a label will be read incorrectly.

	I 2 of 5 Character Correlation = Disable
I 2 of 5 Character Correlation = Enable	

Datalogic 2 of 5 Stitching

This option enables/disables stitching for Datalogic 2 of 5 labels. When parts of a Datalogic 2 of 5 barcode are presented to the reader with this feature enabled, the barcode parts will be assembled by the reader's software, and the data will be decoded if all barcode proofing requirements are met.

	Datalogic 2 of 5 Stitching = Disable
Datalogic 2 of 5 Stitching = Enable	



CODABAR

The following options apply to the Codabar symbology.

Codabar Enable/Disable

When disabled, the reader will not read Codabar barcodes.

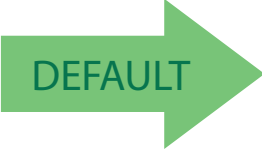
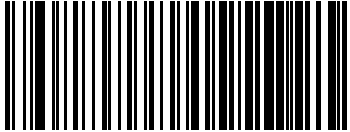
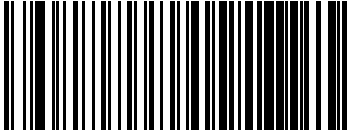
	 <p>Codabar = Disable</p>
 <p>Codabar = Enable</p>	

Codabar Check Character Calculation

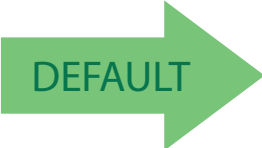
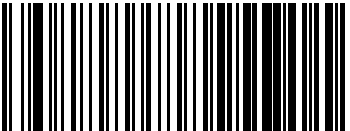
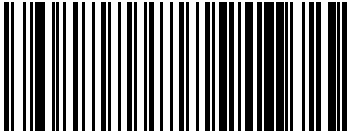
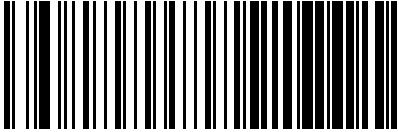

Enable this option to enables/disables calculation and verification of an optional Codabar check character. When disabled, any check character in the label is treated as a data character

	 <p>Codabar Check Character Calculation = Don't Calculate</p>
 <p>Codabar Check Character Calculation = Enable AIM standard check char.</p>	
	 <p>Codabar Check Character Calculation = Enable Modulo 10 check char.</p>



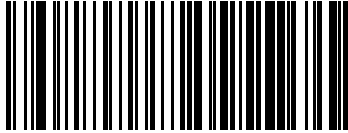
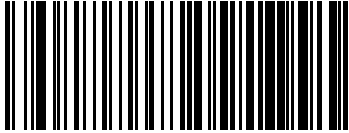

Codabar Check Character Transmission

Enable this option to transmit the check character along with Codabar barcode data.

	 Codabar Check Character Transmission = Don't Send
 Codabar Check Character Transmission = Send	

Codabar Start/Stop Character Transmission

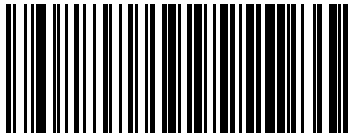
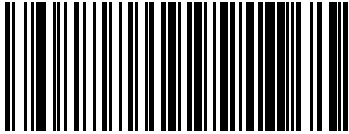
Enable this option to enable/disable transmission of Codabar start and stop characters.

	 Codabar Start/Stop Character Transmission = Don't Transmit
 Codabar Start/Stop Character Transmission = Transmit	



ENTER/EXIT PROGRAMMING MODE

Codabar Start/Stop Character Set

Codabar Start/Stop Character Set

This option specifies the format of transmitted Codabar start/stop characters.

	 Codabar Check Character Set = ABCD/TN*E
 Codabar Check Character Set = ABCD/ABCD	
	 Codabar Check Character Set = abcd/tn*e
 Codabar Check Character Set = abcd/abcd	

Codabar Start/Stop Character Match

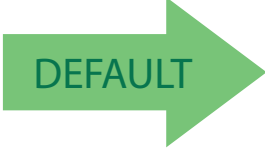
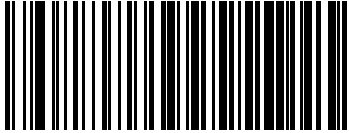
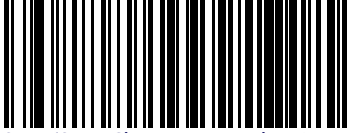

When enabled, this option requires that start and stop characters match.

	 Codabar Start/Stop Character Match = Don't Require Match
 Codabar Start/Stop Character Match = Require Match	

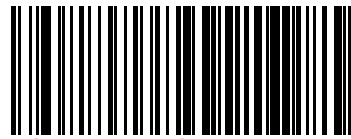

Codabar Quiet Zones

Specifies the number of quiet zones for Codabar labels. Quiet zones are blank areas at the ends of a barcode and are typically 10 times the width of the narrowest bar or space in the label.

 <p>Codabar Quiet Zones = Quiet Zone on one side</p>	
	 <p>Codabar Quiet Zones = Quiet Zones on two sides</p>
 <p>Codabar Quiet Zones = Auto</p>	
	 <p>Codabar Quiet Zones = Virtual Quiet Zones on two sides</p>
 <p>Codabar Quiet Zones = Small Quiet Zones on two sides</p>	

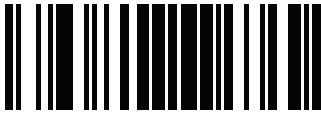

Codabar Minimum Reads



This feature specifies the minimum number of consecutive times a Codabar label must be decoded before it is accepted as good read.

	 Codabar Minimum Reads = 1
 Codabar Minimum Reads = 2	
	 Codabar Minimum Reads = 3
 Codabar Minimum Reads = 4	

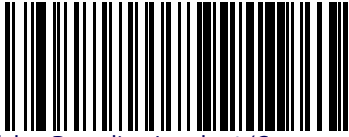
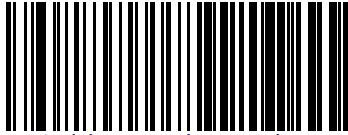
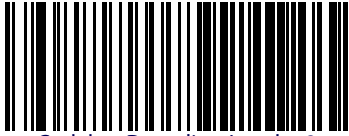

Codabar Decoding Level

Decoding Levels are used to configure a barcode symbology decoder to be very aggressive to very conservative, depending on a particular customer's needs. See [page 255](#) for more information on this feature.

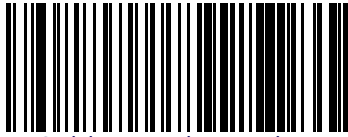
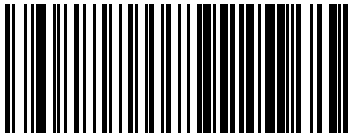
 <p>Codabar Decoding Level = 1 (Conservative)</p>	
	 <p>Codabar Decoding Level = 2</p>
 <p>Codabar Decoding Level = 3</p>	
	 <p>Codabar Decoding Level = 4</p>
 <p>Codabar Decoding Level = 5</p>	



Codabar Length Control

This feature specifies either variable length decoding or fixed length decoding for the Codabar symbology.

Variable Length. For variable length decoding, a minimum and maximum length may be set.

Fixed Length. For fixed length decoding, two different lengths may be set.

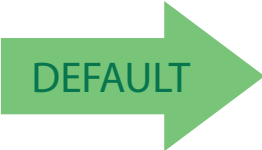
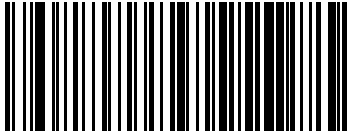
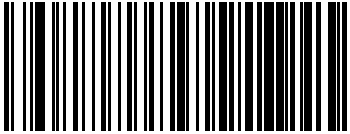
	 Codabar Length Control = Variable Length
 Codabar Length Control = Fixed Length	

Codabar Set Length 1

This feature specifies one of the barcode lengths for [Codabar Length Control](#). Length 1 is the minimum label length if in [Variable Length Mode](#), or the first fixed length if in [Fixed Length Mode](#). Length includes the barcode’s start, stop, check and data characters. The length must include at least one data character. The length can be set from 3 to 50 characters.

Table 14 provides some examples for setting Length 1. See [page 256](#) for detailed instructions on setting this feature.

Table 14. Codabar Length 1 Setting Examples

STEP	ACTION	EXAMPLES			
1	Desired Setting (and pad with leading zeroes)	03 Characters	09 Characters	15 Characters	50 Characters
2	Scan ENTER/EXIT PROGRAMMING MODE				
3	Scan SELECT CODABAR LENGTH 1 SETTING				
4	Scan Two Characters From Appendix D, Keypad	'0' and '3'	'0' and '9'	'1' and '5'	'5' AND '0'
5	Scan ENTER/EXIT PROGRAMMING MODE				



Make a mistake? Scan the CANCEL barcode to abort and not save the entry string. You can then start again at the beginning.

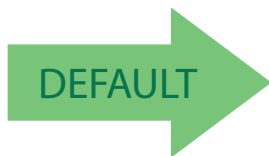

03 = Length 1 is 3 Characters



Codabar Set Length 2

This feature specifies one of the barcode lengths for **Codabar Length Control**. Length 2 is the maximum label length if in **Variable Length Mode**, or the second fixed length if in **Fixed Length Mode**. The length includes the barcode’s start, stop, check and data characters. The length must include at least one data character.

The length can be set from 3 to 50 characters. A setting of 0 specifies to ignore this length (only one fixed length).

Table 15 provides examples for setting Length 2. See [page 256](#) for detailed instructions on setting this feature.

Table 15. Codabar Length 2 Setting Examples

STEP	ACTION	EXAMPLES			
1	Desired Setting (and pad with leading zeroes)	00 Ignore This Length	07 Characters	15 Characters	50 Characters
2	Scan ENTER/EXIT PROGRAMMING MODE				
3	Scan SELECT CODABAR LENGTH 2 SETTING				
4	Scan Two Characters From Appendix D, Keypad	'0' and '0'	'0' and '7'	'1' and '5'	'5' AND '0'
5	Scan ENTER/EXIT PROGRAMMING MODE				

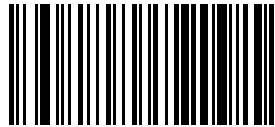

Select Codabar Length 2 Setting

Make a mistake? Scan the CANCEL barcode to abort and not save the entry string. You can then start again at the beginning.

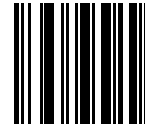

CANCEL

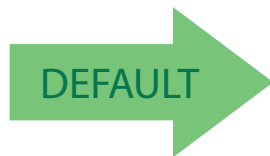

50 = Length 2 is 50 Characters



Codabar Interdigit Ratio

This feature specifies the ratio between an intercharacter space and module for Codabar labels.

	 <p>Codabar Interdigit Ratio = Disable</p>
 <p>Codabar Interdigit Ratio = 1</p>	
	 <p>Codabar Interdigit Ratio = 2</p>
 <p>Codabar Interdigit Ratio = 3</p>	
	 <p>Codabar Interdigit Ratio = 4</p>
 <p>Codabar Interdigit Ratio = 5</p>	



ENTER/EXIT PROGRAMMING MODE

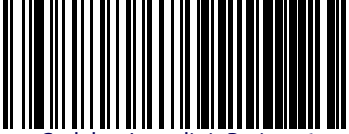
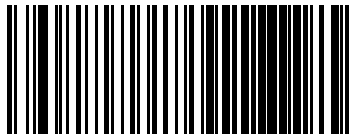
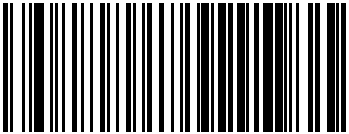
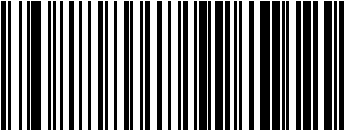

Codabar Interdigit Ratio

Codabar Interdigit Ratio — cont.

	 <p>Codabar Interdigit Ratio = 6</p>
 <p>Codabar Interdigit Ratio = 7</p>	
	 <p>Codabar Interdigit Ratio = 8</p>
 <p>Codabar Interdigit Ratio = 9</p>	
	 <p>Codabar Interdigit Ratio = 10</p>

Codabar Character Correlation

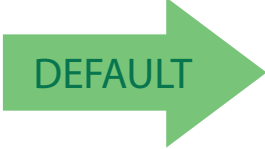
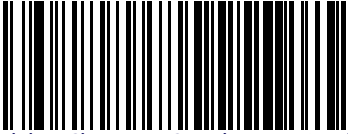
When correlation is enabled, the barcode reader will combine label data from multiple scans when decoding. Enabling correlation will help the scanner read labels that have some spots and/or voids. It may also help read labels that have damaged areas. Enabling correlation will also increase the chances that a label will be read incorrectly.

	 Codabar Character Correlation = Disable
 Codabar Character Correlation = Enable	

Codabar Stitching

This option enables/disables stitching for Codabar labels. When parts of a Codabar barcode are presented to the reader with this feature enabled, the barcode parts will be assembled by the reader's software, and the data will be decoded if all barcode proofing requirements are met.

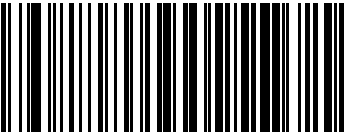
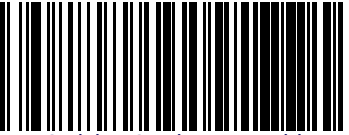
	 Codabar Stitching = Disable
 Codabar Stitching = Enable	



ABC CODABAR

The following options apply to the ABC Codabar symbology.



ABC Codabar Enable/Disable

Enables/Disables ability of reader to decode ABC Codabar labels.

ABC Codabar Concatenation Mode

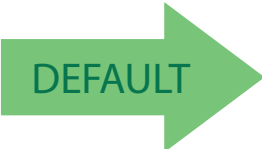

Specifies the concatenation mode between Static and Dynamic.

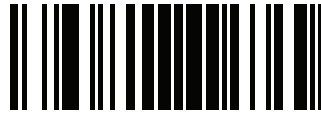

ABC Codabar Dynamic Concatenation Timeout

Specifies the timeout in 10-millisecond ticks used by the ABC Codabar Dynamic Concatenation Mode.

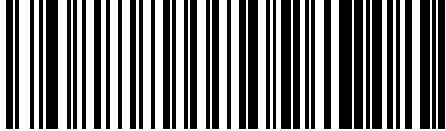
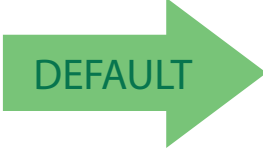
	 ABC Codabar Dynamic Concatenation Timeout = 50 msec
 ABC Codabar Dynamic Concatenation Timeout = 100 msec	
	 ABC Codabar Dynamic Concatenation Timeout = 200 msec
 ABC Codabar Dynamic Concatenation Timeout = 500 msec	
	 ABC Codabar Dynamic Concatenation Timeout = 750 msec
 ABC Codabar Dynamic Concatenation Timeout = 1 Second	

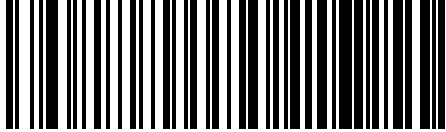
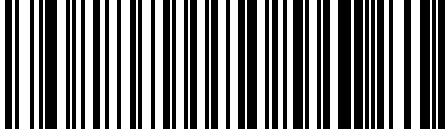
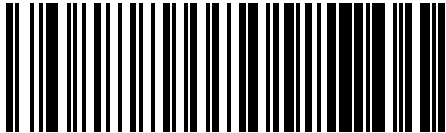

GS1 DATABAR™ OMNIDIRECTIONAL

The following options apply to the GS1 DataBar™ Omnidirectional (formerly RSS-14) symbology.

GS1 DataBar™ Omnidirectional Enable/Disable

When disabled, the reader will not read GS1 DataBar™ Omnidirectional barcodes.

	 GS1 DataBar™ Omnidirectional = Disable
 GS1 DataBar™ Omnidirectional = Enable	

GS1 DataBar™ Omnidirectional GS1-128 Emulation

When enabled, GS1 DataBar™ Omnidirectional barcodes will be translated to the GS1-128 label data format.

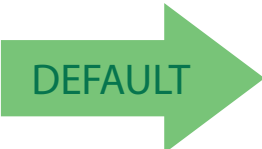
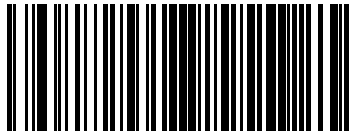
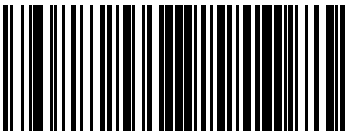
	 GS1 DataBar™ Omnidirectional GS1-128 Emulation = Disable
 GS1 DataBar™ Omnidirectional GS1-128 Emulation = Enable	



GS1 DataBar™ Omnidirectional Minimum Reads

This feature specifies the minimum number of consecutive times a GS1 DataBar™ Omnidirectional label must be decoded before it is accepted as good read.

	 <p>GS1 DataBar™ Omnidirectional Minimum Reads = 1</p>
 <p>GS1 DataBar™ Omnidirectional Minimum Reads = 2</p>	
	 <p>GS1 DataBar™ Omnidirectional Minimum Reads = 3</p>
 <p>GS1 DataBar™ Omnidirectional Minimum Reads = 4</p>	



GS1 DATABAR™ EXPANDED

The following options apply to the GS1 DataBar™ Expanded (formerly RSS Expanded) symbology.



GS1 DataBar™ Expanded Enable/Disable

When disabled, the reader will not read GS1 DataBar™ Expanded barcodes.

	 GS1 DataBar™ Expanded = Disable
 GS1 DataBar™ Expanded = Enable	

GS1 DataBar™ Expanded GS1-128 Emulation

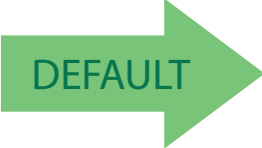
When enabled, GS1 DataBar™ Expanded barcodes will be translated to the GS1-128 label data format.

	 GS1 DataBar™ Expanded GS1-128 Emulation = Disable
 GS1 DataBar™ Expanded GS1-128 Emulation = Enable	

GS1 DataBar™ Expanded Minimum Reads

This feature specifies the minimum number of consecutive times a GS1 DataBar™ Expanded label must be decoded before it is accepted as good read.

	 GS1 DataBar™ Expanded Minimum Reads = 1
 GS1 DataBar™ Expanded Minimum Reads = 2	
	 GS1 DataBar™ Expanded Minimum Reads = 3
 GS1 DataBar™ Expanded Minimum Reads = 4	

GS1 DataBar™ Expanded Length Control

This feature specifies either variable length decoding or fixed length decoding for the GS1 DataBar™ Expanded symbology.

Variable Length. For variable-length decoding, a minimum length may be set.

Fixed Length. For fixed-length decoding, two different lengths may be set.

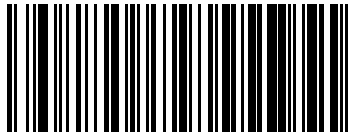
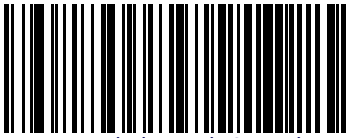
	 GS1 DataBar™ Expanded Length Control = Variable Length
 GS1 DataBar™ Expanded Length Control = Fixed Length	



GS1 DataBar™ Expanded Set Length 1

This feature specifies one of the barcode lengths for [GS1 DataBar™ Expanded Length Control](#). Length 1 is the minimum label length if in [Variable Length](#) Mode, or the first fixed length if in [Fixed Length](#) Mode. Length includes the barcode’s data characters only. The length can be set from 1 to 74 characters.

Table 16 provides some examples for setting Length 1. See [page 256](#) for detailed instructions on setting this feature.

Table 16. GS1 DataBar™ Expanded Length 1 Setting Examples

STEP	ACTION	EXAMPLES			
1	Desired Setting	01 Character	07 Characters	52 Characters	74 Characters
2	Scan ENTER/EXIT PROGRAMMING MODE				
3	Scan SELECT GS1 DataBar™ EXPANDED LENGTH 1SETTING				
4	Scan Two Characters From Appendix D, Keypad	'0' and '1'	'0' and '7'	'5' and '2'	'7' AND '4'
5	Scan ENTER/EXIT PROGRAMMING MODE				



Select GS1 DataBar™ Expanded Set Length 1 Setting

Make a mistake? Scan the CANCEL barcode to abort and not save the entry string. You can then start again at the beginning.

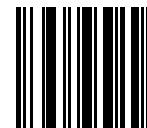

CANCEL

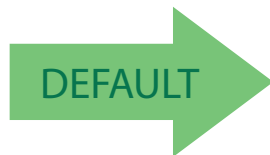

01 = Length 1 is 1 Character



GS1 DataBar™ Expanded Set Length 2

This feature specifies one of the barcode lengths for [GS1 DataBar™ Expanded Length Control](#). Length 2 is the maximum label length if in [Variable Length](#) Mode, or the second fixed length if in [Fixed Length](#) Mode. Length includes the barcode’s data characters only. The length can be set from 1 to 74 characters. A setting of 0 specifies to ignore this length (only one fixed length).

Table 17 provides examples for setting Length 2. See [page 256](#) for detailed instructions on setting this feature.

Table 17. GS1 DataBar™ Expanded Length 2 Setting Examples

STEP	ACTION	EXAMPLES			
1	Desired Setting	00 (ignore second length)	07 Characters	52 Characters	74 Characters
2	Scan ENTER/EXIT PROGRAMMING MODE				
3	Scan SELECT GS1 DataBar™ EXPANDED LENGTH 2 SETTING				
4	Scan Two Characters From Appendix D, Keypad	'0' and '0'	'0' and '7'	'5' and '2'	'7' and '4'
5	Scan ENTER/EXIT PROGRAMMING MODE				

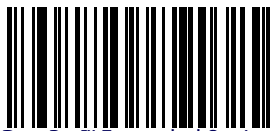

Select GS1 DataBar™ Expanded Set Length 2 Setting

Make a mistake? Scan the CANCEL barcode to abort and not save the entry string. You can then start again at the beginning.

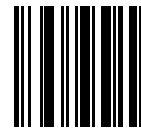

CANCEL

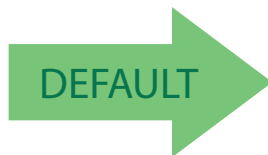

74 = Length 2 is 74 Characters



GS1 DATABAR™ LIMITED

The following options apply to the GS1 DataBar™ Limited (formerly RSS Limited) symbology.

GS1 DataBar™ Limited Enable/Disable

When disabled, the reader will not read GS1 DataBar™ Limited barcodes.

	 GS1 DataBar™ Limited = Disable
 GS1 DataBar™ Limited = Enable	

GS1 DataBar™ Limited GS1-128 Emulation

When enabled, GS1 DataBar™ Limited barcodes will be translated to the GS1-128 label data format.

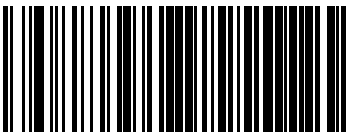
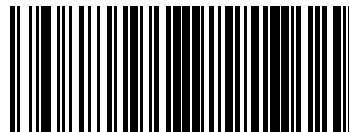
	 GS1 DataBar™ Limited GS1-128 Emulation = Disable
 GS1 DataBar™ Limited GS1-128 Emulation = Enable	

GS1 DataBar™ Limited Minimum Reads

This feature specifies the minimum number of consecutive times a GS1 DataBar™ Limited label must be decoded before it is accepted as good read.

	 <p>GS1 DataBar™ Limited Minimum Reads = 1</p>
 <p>GS1 DataBar™ Limited Minimum Reads = 2</p>	
	 <p>GS1 DataBar™ Limited Minimum Reads = 3</p>
 <p>GS1 DataBar™ Limited Minimum Reads = 4</p>	



CODE 93

The following options apply to the Code 93 symbology.

Code 93 Enable/Disable

Enables/Disables ability of reader to decode Code 93 labels.

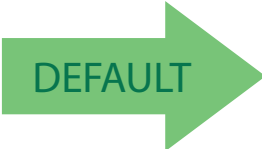
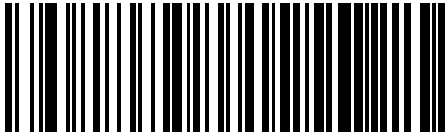
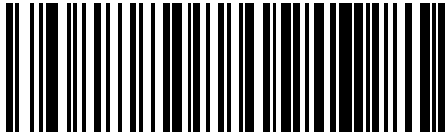
Code 93 Check Character Calculation

Enables/disables calculation and verification of an optional Code 93 check character.



Code 93 Check Character Transmission

Enables/disables transmission of an optional Code 93 check character.

	 <p>Code 93 Check Character Transmission = Disable</p>
 <p>Code 93 Check Character Transmission = Enable</p>	

Code 93 Length Control

This feature specifies either variable length decoding or fixed length decoding for the Code 93 symbology.

Variable Length. For variable length decoding, a minimum and maximum length may be set.

Fixed Length. For fixed length decoding, two different lengths may be set.

	 <p>Code 93 Length Control = Variable Length</p>
 <p>Code 93 = Fixed Length</p>	



Code 93 Set Length 1

Specifies one of the barcode lengths for [Code 93 Length Control](#). Length 1 is the minimum label length if in [Variable Length Mode](#), or the first fixed length if in [Fixed Length Mode](#). Length includes the barcode's data characters only. The length can be set from 01 to 50 characters.

Table 18 provides some examples for setting Length 1. See [page 256](#) for detailed instructions on setting this feature.

Table 18. Code 93 Length 1 Setting Examples

STEP	ACTION	EXAMPLES			
1	Desired Setting	01 Characters	07 Characters	15 Characters	50 Characters
2	Scan ENTER/EXIT PROGRAMMING MODE				
3	Scan SELECT CODE 93 LENGTH 1 SETTING				
4	Scan Two Characters From Appendix D, Keypad	'0' and '1'	'0' and '7'	'1' and '5'	'5' AND '0'
5	Scan ENTER/EXIT PROGRAMMING MODE				

 Select Code 93 Set Length 1 Setting	
--	--

Make a mistake? Scan the CANCEL barcode to abort and not save the entry string. You can then start again at the beginning.

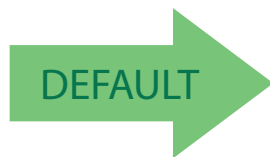

01 = Length 1 is 1 Character

Code 93 Set Length 2

This feature specifies one of the barcode lengths for [Code 93 Length Control](#). Length 2 is the maximum label length if in [Variable Length Mode](#), or the second fixed length if in [Fixed Length Mode](#). Length includes the barcode's check, data, and full-ASCII shift characters. The length does not include start/stop characters. The length can be set from 1 to 50 characters. A setting of 0 specifies to ignore this length (only one fixed length).

Table 19 provides examples for setting Length 2. See [page 256](#) for detailed instructions on setting this feature.

Table 19. CODE 93 Length 2 Setting Examples

STEP	ACTION	EXAMPLES			
1	Desired Setting	00 (Ignore This Length)	07 Characters	15 Characters	50 Characters
2	Scan ENTER/EXIT PROGRAMMING MODE				
3	Scan SELECT CODE 93 LENGTH 2 SETTING				
4	Scan Two Characters From Appendix D, Keypad	'0' and '0'	'0' and '7'	'1' and '5'	'5' AND '0'
5	Scan ENTER/EXIT PROGRAMMING MODE				



Make a mistake? Scan the CANCEL barcode to abort and not save the entry string. You can then start again at the beginning.



DEFAULT

50 = Length 2 is 50 Characters



Code 93 Minimum Reads





This feature specifies the minimum number of consecutive times a Code 93 label must be decoded before it is accepted as good read.

	 Code 93 Minimum Reads = 1
 Code 93 Minimum Reads = 2	
	 Code 93 Minimum Reads = 3
 Code 93 Minimum Reads = 4	

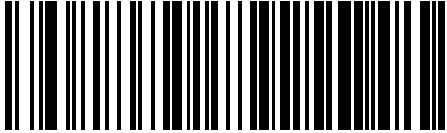
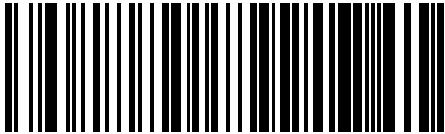
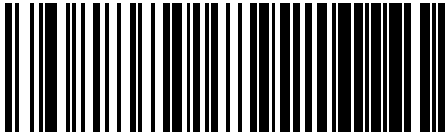
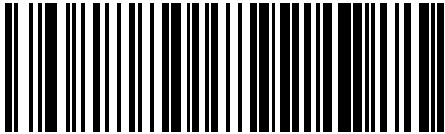

Code 93 Decoding Level

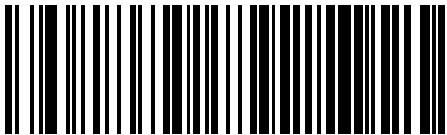
Specifies the decoding level for Code 93. Decoding Levels are used to configure a barcode symbology decoder to be very aggressive to very conservative depending on a particular customer's needs. See [page 255](#) for more information on this feature.

	 Code 93 Decoding Level = Disable
 Code 93 Decoding Level = 1 (Conservative)	
	 Code 93 Decoding Level = 2
 Code 93 Decoding Level = 3	
	 Code 93 Decoding Level = 4
 Code 93 Decoding Level = 5 (Aggressive)	



ENTER/EXIT PROGRAMMING MODE

Code 93 Quiet Zones

Code 93 Quiet Zones

Enables/disables quiet zones for Code 93.

	 <p>Code 93 Quiet Zones = No Quiet Zones</p>
 <p>Code 93 Quiet Zones = Quiet Zone on one side</p>	
	 <p>Code 93 Quiet Zones = Quiet Zones on two sides</p>
 <p>Code 93 Quiet Zones = Auto</p>	
	 <p>Code 93 Quiet Zones = Virtual Quiet Zones on two sides</p>

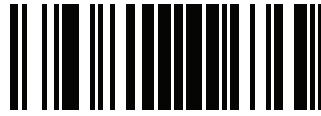



Code 93

ENTER/EXIT PROGRAMMING MODE

Code 93 Character Correlation

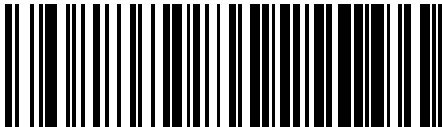
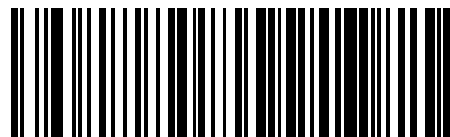
Enables/disables Character Correlation for Code 93.

	 Code 93 Character Correlation = Disable
 Code 93 Character Correlation = Enable	

Code 93 Stitching

Disable/enable fixed or variable length stitching for Code 93.

	 Code 93 Stitching = Disable
 Code 93 Stitching = Enable	



ENTER/EXIT PROGRAMMING MODE

MSI Enable/Disable

MSI

The following options apply to the MSI symbology.

MSI Enable/Disable

Enables/Disables ability of reader to decode MSI labels.

	 <p>MSI = Disable</p>
 <p>MSI = Enable</p>	

MSI Check Character Calculation

Enables/Disables calculation and verification of an optional MSI check character.

	 <p>MSI Check Character Calculation = Disable</p>
 <p>MSI Check Character Calculation = Enable Mod10</p>	
	 <p>MSI Check Character Calculation = Enable Mod11/10</p>
 <p>MSI Check Character Calculation = Enable Mod10/10</p>	





MSI

ENTER/EXIT PROGRAMMING MODE

MSI Check Character Transmission

Enables/disables transmission of an MSI check character.

	 <p>MSI Check Character Transmission = Disable</p>
 <p>MSI Check Character Transmission = Enable</p>	

MSI Length Control

This feature specifies either variable length decoding or fixed length decoding for the MSI symbology.

Variable Length. For variable length decoding, a minimum and maximum length may be set.

Fixed Length. For fixed length decoding, two different lengths may be set.

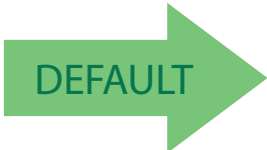
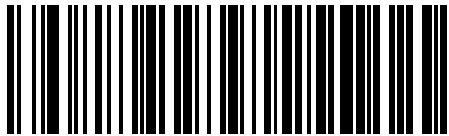
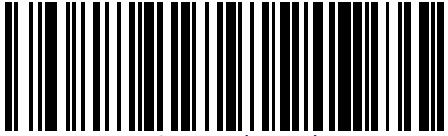
	 <p>MSI Length Control = Variable Length</p>
 <p>MSI = Fixed Length</p>	



MSI Set Length 1

This feature specifies one of the barcode lengths for [MSI Length Control](#). Length 1 is the minimum label length if in [Variable Length Mode](#), or the first fixed length if in [Fixed Length Mode](#). Length includes the barcode’s data characters only. The length can be set from 01 to 50 characters.

Table 20 provides some examples for setting Length 1. See [page 256](#) for detailed instructions on setting this feature.

Table 20. MSI Length 1 Setting Examples

STEP	ACTION	EXAMPLES			
1	Desired Setting	01 Characters	07 Characters	15 Characters	50 Characters
2	Scan ENTER/EXIT PROGRAMMING MODE				
3	Scan SELECT MSI LENGTH 1 SETTING				
4	Scan Two Characters From Appendix D, Keypad	'0' and '1'	'0' and '7'	'1' and '5'	'5' AND '0'
5	Scan ENTER/EXIT PROGRAMMING MODE				

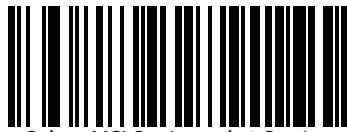

Select MSI Set Length 1 Setting

Make a mistake? Scan the CANCEL barcode to abort and not save the entry string. You can then start again at the beginning.

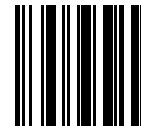

CANCEL

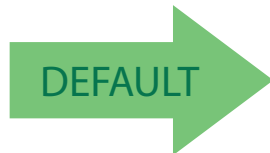

01 = Length 1 is 1 Character



MSI Set Length 2

This feature specifies one of the barcode lengths for [MSI Length Control](#). Length 2 is the maximum label length if in [Variable Length Mode](#), or the second fixed length if in [Fixed Length Mode](#). Length includes the barcode’s check, data, and full-ASCII shift characters. The length does not include start/stop characters. The length can be set from 1 to 50 characters. A setting of 0 specifies to ignore this length (only one fixed length).

Table 21 provides examples for setting Length 2. See [page 256](#) for detailed instructions on setting this feature.

Table 21. MSI Length 2 Setting Examples

STEP	ACTION	EXAMPLES			
1	Desired Setting	00 (Ignore This Length)	07 Characters	15 Characters	50 Characters
2	Scan ENTER/EXIT PROGRAMMING MODE				
3	Scan SELECT MSI LENGTH 2 SETTING				
4	Scan Two Characters From Appendix D, Keypad	'0' and '0'	'0' and '7'	'1' and '5'	'5' AND '0'
5	Scan ENTER/EXIT PROGRAMMING MODE				



Select MSI Length 2 Setting

Make a mistake? Scan the CANCEL barcode to abort and not save the entry string. You can then start again at the beginning.

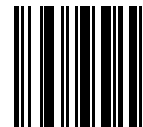

CANCEL

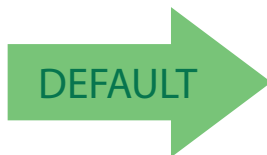

50 = Length 2 is 50 Characters



MSI Minimum Reads

This feature specifies the minimum number of consecutive times an MSI label must be decoded before it is accepted as good read.

	 MSI Minimum Reads = 1
 MSI Minimum Reads = 2	
	 MSI Minimum Reads = 3
 MSI Minimum Reads = 4	



MSI Decoding Level



Specifies the decoding level for MSI. Decoding Levels are used to configure a barcode symbology decoder to be very aggressive to very conservative depending on a particular customer's needs. See [page 255](#) for more information on this feature.

	 MSI Decoding Level = Disable
 MSI Decoding Level = 1 (conservative)	
	 MSI Decoding Level = 2
 MSI Decoding Level = 3	
	 MSI Decoding Level = 4
 MSI Decoding Level = 5 (aggressive)	

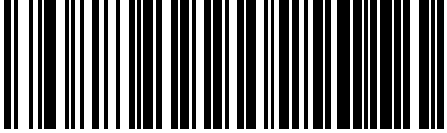

MSI Stitching

Enables/disables fixed length stitching for MSI.

	 MSI Stitching = Disable
 MSI Stitching = Enable	

MSI Character Correlation

Enables/disables Character Correlation for MSI.

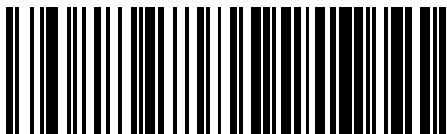
	 MSI Character Correlation = Disable
 MSI Character Correlation = Enable	





PLESSEY

The following options apply to the Plessey symbology.

Plessey Enable/Disable

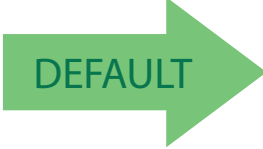
Enables/Disables ability of reader to decode Plessey labels.







ENTER/EXIT PROGRAMMING MODE

Plessey Check Character Calculation

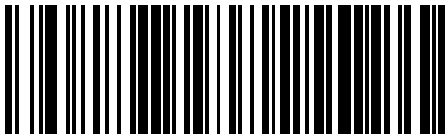

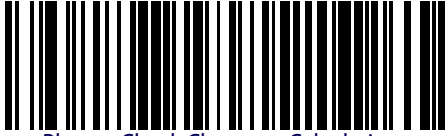
Plessey Check Character Calculation

Enables/Disables calculation and verification of an optional Plessey check character.

	 <p>Plessey Check Character Calculation = Disable</p>
 <p>Plessey Check Character Calculation = Enable Plessey std. check char. verification</p>	
	 <p>Plessey Check Character Calculation = Enable Anker check char. verification</p>
 <p>Plessey Check Character Calculation = Enable Plessey std. and Anker check char verification</p>	

Plessey Check Character Transmission

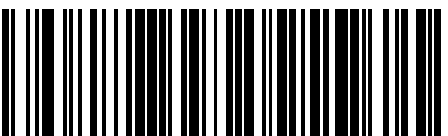
Enables/disables transmission of an MSI check character.

	 <p>Plessey Check Character Transmission = Disable</p>
 <p>Plessey Check Character Transmission = Enable</p>	



Plessey Length Control

This feature specifies either variable length decoding or fixed length decoding for the Plessey symbology.

Variable Length. For variable length decoding, a minimum and maximum length may be set.

Fixed Length. For fixed length decoding, two different lengths may be set.

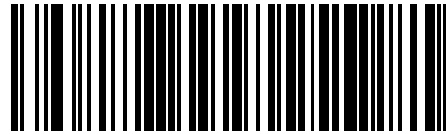
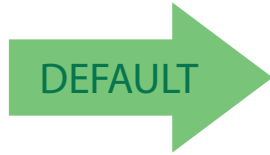

Plessey Length Control = Variable Length

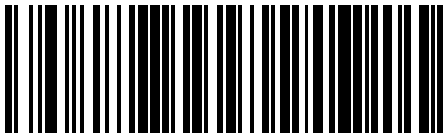

Plessey = Fixed Length



Plessey Set Length 1

This feature specifies one of the barcode lengths for [Plessey Length Control](#). Length 1 is the minimum label length if in [Variable Length Mode](#), or the first fixed length if in [Fixed Length Mode](#). Length includes the barcode’s data characters only. The length can be set from 01 to 50 characters.

Table 22 provides some examples for setting Length 1. See [page 256](#) for detailed instructions on setting this feature.

Table 22. Plessey Length 1 Setting Examples

STEP	ACTION	EXAMPLES			
1	Desired Setting	01 Characters	07 Characters	15 Characters	50 Characters
2	Scan ENTER/EXIT PROGRAMMING MODE				
3	Scan SELECT Plessey LENGTH 1 SETTING				
4	Scan Two Characters From Appendix D, Keypad	'0' and '1'	'0' and '7'	'1' and '5'	'5' AND '0'
5	Scan ENTER/EXIT PROGRAMMING MODE				



Select Plessey Set Length 1 Setting

Make a mistake? Scan the CANCEL barcode to abort and not save the entry string. You can then start again at the beginning.



CANCEL

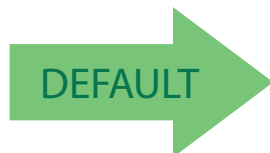

01 = Length 1 is 1 Character



Plessey Set Length 2

This feature specifies one of the barcode lengths for [Plessey Length Control](#). Length 2 is the maximum label length if in [Variable Length Mode](#), or the second fixed length if in [Fixed Length Mode](#). Length includes the barcode’s check, data, and full-ASCII shift characters. The length does not include start/stop characters.

The length can be set from 1 to 50 characters. A setting of 0 specifies to ignore this length (only one fixed length).

Table 23 provides examples for setting Length 2. See [page 256](#) for detailed instructions on setting this feature.

Table 23. Plessey Length 2 Setting Examples

STEP	ACTION	EXAMPLES			
1	Desired Setting	00 (Ignore This Length)	07 Characters	15 Characters	50 Characters
2	Scan ENTER/EXIT PROGRAMMING MODE				
3	Scan SELECT PLESSEY LENGTH 2 SETTING				
4	Scan Two Characters From Appendix D, Keypad	'0' and '0'	'0' and '7'	'1' and '5'	'5' AND '0'
5	Scan ENTER/EXIT PROGRAMMING MODE				



Make a mistake? Scan the CANCEL barcode to abort and not save the entry string. You can then start again at the beginning.

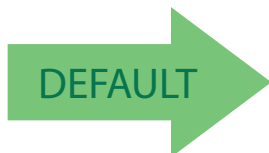

50 = Length 2 is 50 Characters



Plessey Minimum Reads





This feature specifies the minimum number of consecutive times a Plessey label must be decoded before it is accepted as good read.

	 Plessey Minimum Reads = 1
 Plessey Minimum Reads = 2	
	 Plessey Minimum Reads = 3
 Plessey Minimum Reads = 4	

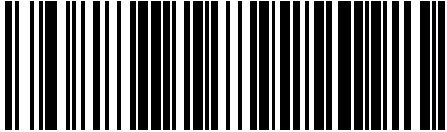
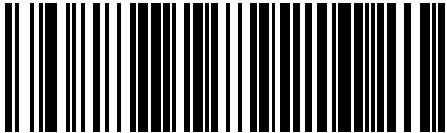

Plessey Decoding Level



Specifies the decoding level for Plessey. Decoding Levels are used to configure a barcode symbology decoder to be very aggressive to very conservative depending on a particular customer's needs. See [page 255](#) for more information on this feature.

	 Plessey Decoding Level = Disable
 Plessey Decoding Level = 1 (conservative)	
	 Plessey Decoding Level = 2
 Plessey Decoding Level = 3	
	 Plessey Decoding Level = 4
 Plessey Decoding Level = 5 (aggressive)	



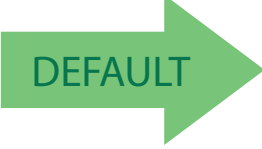

Plessey Stitching

Enables/disables fixed length stitching for Plessey.

	 Plessey Stitching = Disable
 Plessey Stitching = Enable	

Plessey Character Correlation

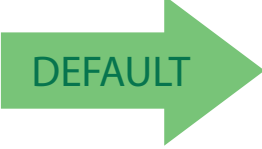
Enables/disables Character Correlation for Plessey.

	 Plessey Character Correlation = Disable
 Plessey Character Correlation = Enable	



NOTES

Chapter 4

Software Configuration Strings

RS-232 models (as well as USB models with the USB-COM Interface selected) can be configured using the serial strings contained in this chapter.

To configure RS-232 models by using the configuration strings:

1. Connect your reader to a PC RS-232 port according to the information in [Installing the Interface Cable, starting on page 12](#). Set the PC serial port to the default RS-232 communication parameters (see [Standard Defaults, starting on page 263](#)).



To configure the reader using configuration strings you must enter Service Mode, which automatically sets the reader communication to 115200 baud rate. You must therefore set the host accordingly for RS-232 communications. Upon exiting Service Mode, the programmed baud rate will be restored.

2. Using a Terminal Emulation Program, send the Restore Current Interface (Custom) Default string to the reader using the syntax described on the next page.
3. Send all the necessary command strings according to your application's requirements.

To configure USB models (only for USB-COM Interface) by using the configuration strings:



USB models by default have the USB-KBD Interface selected and are easily configured by reading the barcodes in [Setting the Interface, starting on page 13](#).

1. Download and install the USB-COM driver from www.scanning.datalogic.com.
2. Connect your reader to a PC USB port according to the information in [Installing the Interface Cable, starting on page 12](#).
3. Change the interface to USB-COM by reading the barcode below.

USB-COM

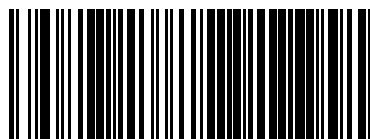

4. Using a Terminal Emulation Program, send the Restore Current Interface (Custom) Default string to the reader using the syntax described on the next page.
5. Send all the necessary command strings according to your application's requirements.

Command Syntax

1. Enter Service (Serial String Programming) Mode

`$$<CR>`



This command automatically sets the reader communication to 115200 baud rate. Before continuing, please set the baud rate of the Terminal Emulation Program to 115200.

2. Send Command

\$	<i>Command</i>	<i>Parameter</i>	<i>Value</i>	<CR>
----	----------------	------------------	--------------	------

Where:

Command:	Description
HAXX	Interface Selection
AA	Enable All Symbologies
AD	Disable All Symbologies
R	Reset Reader
CXXXXXX	Write Single Configuration Item to RAM
Parameter:	
XXXX	A 4-character ASCII string See Serial Configuration Strings Table
Value:	
XX	A 2-character Hex string See Serial Configuration Strings Table

3. Apply and Save Configuration to FLASH (permanent memory) and Exit Service Mode

`$Ar<CR>`



This command automatically returns to the programmed baud rate. Before continuing, please set the baud rate of the Terminal Emulation Program to the programmed baud rate.

SERIAL CONFIGURATION STRINGS

ENTER/EXIT CONFIGURATION COMMANDS	
Description	Command
Enter Service Mode (configuration) fixed 115200 Baud rate	S
Exit Service Mode (configuration) return to programmed Baud rate	s
Apply Configuration to RAM (temporary memory) and Exit Service Mode	r01
Apply and Save Configuration to FLASH (permanent memory) and Exit Service Mode	Ar



To configure the reader using configuration strings, it must be placed into Service Mode, which automatically sets the reader communication to 115200 baud rate. You must therefore set the host accordingly for RS-232 communications. Upon exiting Service Mode, the programmed baud rate will be restored.

CONFIGURATION COMMANDS	
Description	Command
Write Single Configuration Item to RAM (temporary memory)	Cxxxxxx
Read Single Configuration Item from RAM (temporary memory)	cxxxx
Reset Reader	R
Read Application Software Release (does not require Enter/Exit Service Mode)	\$\$!
Host Commands Obey	CIFIH00
Host Commands Ignore	CIFIH01
Enable All Symbologies	AA
Disable All Symbologies	AD



The Interface Selection commands store and load the new interface type with its factory defaults into the current configuration.

INTERFACE SELECTION COMMANDS

Description	Command
Restore Current Interface (Custom) Default Configuration	HA00
RS232-STD	HA05
USB-COM	HA47
RS232-Wincor-Nixdorf	HA12
USB-KBD	HA35
USB-KBD-ALT	HA2B
USB KBD-APPLE	HA2C



To read a particular parameter setting from the reader, send the read parameter command without any value. The reader will respond with its currently configured value.

The Read Application Software Release command is a direct command that does not require entering Service Mode.

RS-232 ONLY PARAMETERS

Description		Parameter	Value
Baud Rate	1200	R2BA	00
	2400		01
	4800		02
	9600		03
	19200		04
	38400		05
	57600		06
	115200		07
Parity	none	R2PA	00
	even		01
	odd		02
Data Bits	7	R2DA	00
	8		01
Stop Bits	1	R2ST	00
	2		01
Handshaking Control	RTS	R2HC	00
	RTS/CTS	R2HC	01
	RTS/Xon/Xoff	R2HC	02
	RTS On/CTS	R2HC	03
	RTS/CTS Scan Control	R2HC	04

RS-232/USB-COM PARAMETERS			
Description		Parameter	Value
Intercharacter Delay	No delay or from 10 to 990 ms	R2IC	a
Disable Character	Host command character which disables the reader	R2DC	b
Enable Character	Host command character which enables the reader	R2EC	b
ACK/NAK Options	Disable	R2AE	00
	Enable for label transmission		01
	Enable for host command acknowledge		02
	Enable for label transmission and host command acknowledge		03
ACK Character	Selects character to be used as ACK	R2AC	c
NAK Character	Selects character to be used as NAK	R2NA	c
ACK/NAK Timeout Value	No timeout or from 200 to 15000 ms	R2AT	d
ACK/NAK Retry Count	From 0 to unlimited retries	R2AR	e
ACK/NAK Error Handling	Ignore errors detected	R2EH	00
	Process errors as valid ACK character		01
	Process errors as valid NAK character		02
Beep On ASCII BEL	Disable	R2BB	00
	Enable		01
Beep On Not-On-File	Disable	BPNF	00
	Enable		01
Indicate Transmission Failure	Disable	R2TF	00
	Enable		01

a = Hex value from **00** to **63** representing the decimal number (*00 = no delay; all others x10 ms*)

b = Hex value from **00** to **FE** representing the ASCII character

c = Hex value from **00** to **FF** representing the ASCII character

d = Hex value from **00** to **4B** representing the decimal number (*00 = timeout disabled; all others x200 ms*)

e = Hex value from **00** to **FF** representing the number of retries (*00 = no retries; 01-FE = 1-254 retries; FF = unlimited retries*)

USB ONLY PARAMETERS			
Description		Parameter	Value
USB suspend mode	Disable	USSE	00
	Enable		01

USB-KBD / USB-KBD-ALT / USB-KBD-APPLE PARAMETERS			
Description		Parameter	Value
Keyboard Country Mode	*US	KBCO	00
	*Belgium		01
	*Britain		02
	Croatia		11
	Czechoslovakia		0E
	Denmark		03
	*France		04
	*Germany		05
	Hungary		0D
	*Italy		06
	Japanese (106 key)		0C
	Norway		07
	Poland		12
	Portugal		08
	Romania		10
	Slovakia		0F
	*Spain		09
	*Sweden		0A
	Switzerland		0B
	Send Control Characters	CTRL + KEY	KBSC
CTRL + SHIFT + KEY			01
Special Function KEY			02
USB Keyboard Speed	1 ms	KBSP	01
	2 ms		02
	3 ms		03
	4 ms		04
	5 ms		05
	6 ms		06
	7 ms		07
	8 ms		08
	9 ms		09
	10 ms		0A

* = Valid for USB-KBD-APPLE

READING PARAMETERS PARAMETERS			
Description		Parameter	Value
Illumination Mode	Disabled	SPIL	00
	Triggered		01
	Enabled		02
Operating Modes	On Line	SNRM	00
	Serial On Line		01
	Automatic		02
	Automatic (Object Sense)		03
Test Mode Multiple	Disabled	SNTM	00
	Enabled		01
Automatic Threshold	From 2 to 255 scans without a code	SNAT	<i>g</i>
Phase Off Event	Trigger Stop	SNTO	00
	Timeout		01
	Trigger Stop-Timeout		02
Timeout	From 40 to 5100 ms	SNET	<i>h</i>
Serial Start	Any string of characters (max 20) between 00-FE	STON	<i>i</i>
Serial Stop	Any string of characters (max 20) between 00-FE	STOF	<i>i</i>
Label Programming Mode	Disabled	FAPM	00
	Enabled		01
Exposure Mode	Continuous	SPST	00
	Strobed	SPST	01

g = Hex value from **02** to **FF** representing the number of scans without a code

h = Hex value from **02** to **FF** representing the decimal number (*x20 ms*)

i = Hex value from **00** to **FE** representing the ASCII character

DATA FORMAT			
Description		Parameter	Value
Data Transmission	On Decode	LFTX	01
	After Phase Off		00
Code Verifier Mode	Disabled	LFCV	00
	Transmit Wrong String		01
	Transmit Wrong Code		02
Match String	Any string of characters (max 20) between 00-FE	COVS	k
Wrong Code String	Any string of characters (max 20) between 00-FE	WCVS	k
Case Conversion	Disable	LFCA	00
	Upper Case		01
	Lower Case		02
Global Prefix (Header)	Any string of characters (max 20) between 00-FE	LFPR	k
Global Suffix (Terminator)	Any string of characters (max 20) between 00-FE	LFSU	k
No Read String	Any string of characters (max 20) between 00-FE	NORS	k
Character Conversion	An 8-character string between 00-FF	LFCH	m
Transmit AIM IDs	Disable	AIEN	00
	Enable		01
Transmit Custom Label IDs	Disable	IDCO	00
	Prefix		01
	Suffix		02
GS1-128 AIM ID	Disable	U8AI	00
	Enable		01

k = Hex value from **00** to **FE** representing the ASCII character

m = 8 Hex values from **00** to **FF** representing the 8 ASCII characters (*FF = no replacement or ignore*)

Custom Code Identifiers	Any string of characters (max 3) between 00-FE		
UPC-A		ABID	<i>k</i>
UPC-E		EBID	<i>k</i>
EAN-8		8BID	<i>k</i>
EAN-13		3BID	<i>k</i>
UPC-A/P2		A2ID	<i>k</i>
UPC-A/P5		A5ID	<i>k</i>
UPC-E/P2		E2ID	<i>k</i>
UPC-E/P5		E5ID	<i>k</i>
EAN-8/P2		82ID	<i>k</i>
EAN-8/P5		85ID	<i>k</i>
EAN-13/P2		32ID	<i>k</i>
EAN-13/P5		35ID	<i>k</i>
ISBN		ISID	<i>k</i>
ISSN		INID	<i>k</i>
GTIN for EAN/UPC w/o Add-On		GBID	<i>k</i>
GTIN for EAN/UPC w P2		G2ID	<i>k</i>
GTIN for EAN/UPC w P5		G5ID	<i>k</i>
Code 39		C3ID	<i>k</i>
Code 32		P3ID	<i>k</i>
Code 128		C8ID	<i>k</i>
GS1-128		U8ID	<i>k</i>
ISBT 128		I8ID	<i>k</i>
Interleaved 2 of 5		I2ID	<i>k</i>
Standard 2 of 5		S2ID	<i>k</i>
Industrial 2 of 5		U2ID	<i>k</i>
Datalogic 2 of 5		D2ID	<i>k</i>
IATA		IAID	<i>k</i>
Codabar		CBID	<i>k</i>
ABC Codabar		ACID	<i>k</i>
GS1 Databar 14 (Omnidirectional)		4BID	<i>k</i>
GS1 Databar Expanded		XBID	<i>k</i>
GS1 Databar Limited		LBID	<i>k</i>

Custom Code Identifiers	Any string of characters (max 3) between 00-FE		
Code 93		C9ID	<i>k</i>
MSI		MSID	<i>k</i>
Plessey		PLID	<i>k</i>

k = Hex value from **00** to **FE** representing the ASCII character

DIGITAL OUTPUT			
Description		Parameter	Value
OUTPUT			
Activation Event	Disable	OUA1	00
	Good Read		01
	No Read		02
	Wrong Code		03
Deactivation Event	Disable	ODU1	00
	Timeout		01
	Reading Phase Active		02
Deactivation Timeout	100 to 25500 ms	OUT1	<i>n</i>
Active Level	Closed	OUL1	00
	Open		01

n = Hex value from **01** to **FF** representing the decimal number (*x100 ms*)

POWER SAVE			
Description		Parameter	Value
Sleep Mode Timeout	Disable	SLTO	00
	10 seconds		01
	30 seconds		02
	1 minute		03
	5 minutes		04
	10 minutes		05

LED AND BEEPER INDICATORS			
Description		Parameter	Value
Power On Alert	Disable	BPPU	00
	Enable		01
Indicate Good Read	On Decode	BPIN	00
	After Transmit		01
Good Read Beep	Disable	BPVO	00
	Enable		01
Good Read Beep Length	Time length from 10 to 2550 ms	BPLE	o
Good Read Led Duration	Time length from 0 to 25,500 ms	LAGL	f
Green Spot Duration	Disable	LSSP	00
	Short 300ms		01
	Medium 500ms		02
Led Indication	On Decode	BPIN	00
	After Transmit		01

o = Hex value from **01** to **FF** representing the decimal number ($\times 10$ ms)

f = Hex value from **00** to **FF** representing the decimal number (**00** = Disable; others $\times 100$ ms)

CODE SELECTION			
Description		Parameter	Value
UPC-A			
UPC-A	Disable	ABEN	00
	Enable		01
Check Character Tx	Disable	ABCT	00
	Enable		01
Expand to EAN-13	Disable	AB3B	00
	Enable		01
Number System Tx	Disable	ABNS	00
	Enable		01
Minimum Reads	One Read	ABMR	01
	Two Reads		02
	Three Reads		03
	Four Reads		04
Coupon Control	Allow all coupon barcodes to be decoded	CPCL	00
	Enable only UPC-A coupon decoding		01
	Enable only GS1 Databar coupon decoding		02
UPC-E			
UPC-E	Disable	EBEN	00
	Enable		01
Check Character Tx	Disable	EBCT	00
	Enable		01
Expand to UPC-A	Disable	EBAB	00
	Enable		01
Expand to EAN-13	Disable	EB3B	00
	Enable		01
Number System Tx	Disable	EBNS	00
	Enable		01
Minimum Reads	One Read	EBMR	01
	Two Reads		02
	Three Reads		03
	Four Reads		04
EAN-13			
EAN-13	Disable	3BEN	00
	Enable		01
Check Character Tx	Disable	3BCT	00
	Enable		01
ISBN Conversion	Disable	3BIS	00

CODE SELECTION			
Description		Parameter	Value
	Enable		01
ISSN Conversion	Disable	3BIN	00
	Enable		01
Flag 1 Character	Disable	3BF1	00
	Enable		01
Minimum Reads	One Read	3BMR	01
	Two Reads		02
	Three Reads		03
	Four Reads		04
Coupon Control	Allow all coupon barcodes to be decoded	CPCL	00
	Enable only UPC-A coupon decoding		01
	Enable only GS1 Databar coupon decoding		02
EAN-8			
EAN-8	Disable	8BEN	00
	Enable		01
Check Character Tx	Disable	8BCT	00
	Enable		01
Expand to EAN-13	Disable	8B3B	00
	Enable		01
Minimum Reads	One Read	8BMR	01
	Two Reads		02
	Three Reads		03
	Four Reads		04
Add-Ons			
P2 Add-On	Disable	ADO2	00
	Enable		01
P5 Add-On	Disable	ADO5	00
	Enable		01
P2 Minimum Reads	One Read	ADM2	01
	Two Reads		02
	Three Reads		03
	Four Reads		04
P5 Minimum Reads	One Read	ADM5	01
	Two Reads		02
	Three Reads		03
	Four Reads		04
Optional Add-On Timer	Timer disabled or from 10 to 300 ms	ADOT	p

p = Hex value from 00 to 1E representing the decimal number (00 = Timer disabled; all others x10 ms)

CODE SELECTION			
Description		Parameter	Value
EAN/UPC Global Settings			
GTIN Format	Disable	GBEN	00
	Enable		01
Decoding Level	Disable	UNDL	00
	Level 1		01
	Level 2		02
	Level 3		03
	Level 4		04
Character Correlation	Disable	UNCO	00
	Enable		01
In-Store Minimum Reads	One Read	INMR	01
	Two Reads		02
	Three Reads		03
	Four Reads		04
Code 39			
Code 39	Disable	C3EN	00
	Enable		01
Code 39 Full ASCII	Disable	C3FA	00
	Enable		01
Code Length Control	Variable	C3LC	00
	Fixed		01
Set Length	Length 1 (or Min Length) from 1 to 50 characters	C3L1	q
	Length 2 (or Max Length) 0 or from 1 to 50 characters	C3L2	q
Code 32 (Italian Pharma)	Disable	P3EN	00
	Enable		01
Code 32 Check Tx	Disable	P3CT	00
	Enable		01
Code 32 Start/Stop Tx	Disable	P3SS	00
	Enable		01
Check Options			
Check Calculation	Disable	C3CC	00
	Enable Standard Check		01
	Enable Mod-7 Check		02
	Enable Italian Post Check		04
	Enable Daimler Chrysler Check		08

q = Hex value from **00** to **32** representing the decimal number

CODE SELECTION			
Description		Parameter	Value
Code 39 Check Tx	Disable	C3CT	00
	Enable		01
Code 39 Start/Stop Tx	Disable	C3SS	00
	Enable		01
Decoding Options			
Minimum Reads	One Read	C3MR	01
	Two Reads		02
	Three Reads		03
	Four Reads		04
Decoding Level	Disable	C3DL	00
	Level 1		01
	Level 2		02
	Level 3		03
	Level 4		04
	Level 5		05
Interdigit Ratio	Any ratio or 1 to 10	C3IR	<i>r</i>
Character Correlation	Disable	C3CO	00
	Enable		01
Quiet Zones	Quiet Zone on One Side	C3LO	01
	Quiet Zones on Two Sides		02
	Auto		03
	Virtual Quiet Zones on Two Sides		04
	Small Quiet Zones on Two Sides		05
Stitching	Disable	C3ST	00
	Enable		01
Code 128 (GS1-128)			
Code 128	Disable	C8EN	00
	Enable		01
GS1-128 Enable	Enable (transmit labels in Code 128 data format)	U8EN	00
	Enable (transmit labels in GS1-128 data format)		01
	Disable		02
Code Length Control	Variable	C8LC	00
	Fixed		01
Set Length	Length 1 (or Min Length) from 1 to 80 characters	C8L1	<i>s</i>
	Length 2 (or Max Length) 0 or from 1 to 80 characters	C8L2	<i>s</i>

r = Hex value from **00** to **0A** representing the decimal number of the interdigit space/module ratio (*00* = any ratio)

s = Hex value from **00** to **50** representing the decimal number

CODE SELECTION			
Description		Parameter	Value
Expand to Code 39	Disable	C8C3	00
	Enable		01
Check Options			
Check Tx	Disable	C8CT	00
	Enable		01
Function Character Tx	Disable	C8TF	00
	Enable		01
Sub-Code Change Tx	Disable	C8SC	00
	Enable		01
Decoding Options			
Minimum Reads	One Read	C8MR	01
	Two Reads		02
	Three Reads		03
	Four Reads		04
Decoding Level	Disable	C8DL	00
	Level 1		01
	Level 2		02
	Level 3		03
	Level 4		04
	Level 5		05
Character Correlation	Disable	C8CO	00
	Enable		01
Quiet Zones	No Quiet Zones	C8LO	00
	Quiet Zone on One Side		01
	Quiet Zones on Two Sides		02
	Auto		03
	Virtual Quiet Zones on Two Sides		04
Stitching	Disable	C8ST	00
	Enable		01
ISBT 128			
ISBT 128 Concatenation	Disable	I8CE	00
	Enable		01
Concatenation Mode	Static	I8CM	00
	Dynamic		01
Dynamic Concat. Timeout	From 50 to 2550 ms	I8DT	t
Chain 0 - Chain 15	Contact Datalogic		

t = Hex value from **05** to **FF** representing the decimal number (*x10 ms*)

CODE SELECTION			
Description		Parameter	Value
Interleaved 2 of 5 (I 2 of 5)			
I 2 of 5	Disable	I2EN	00
	Enable		01
Code Length Control	Variable	I2LC	00
	Fixed		01
Set Length	Length 1 (or Min Length) from 2 to 50 characters (only even numbers)	I2L1	v
	Length 2 (or Max Length) from 0 or from 2 to 50 characters (only even numbers)	I2L2	v
Check Options			
Check Calculation	Disable	I2CC	00
	Enable Standard(Mod 10)		01
	Enable German Parcel		02
	Enable DHL		04
	Enable Daimler Chrysler		08
	Enable Bosch		10
	Enable Italian Post		20
Check Tx	Disable	I2CT	00
	Enable		01
Decoding Options			
Minimum Reads	One Read	I2MR	01
	Two Reads		02
	Three Reads		03
	Four Reads		04
Decoding Level	Disable	I2DL	00
	Level 1		01
	Level 2		02
	Level 3		03
	Level 4		04
	Level 5		05
Character Correlation	Disable	I2CO	00
	Enable		01
Stitching	Disable	I2ST	00
	Enable		01
Zero Pattern	Disable	I2ZP	00
	Enable		01

v = Hex value from **00** or **02** to **32** representing the decimal number

CODE SELECTION			
Description		Parameter	Value
Standard 2 of 5			
Standard 2 of 5	Disable	S2EN	00
	Enable		01
Code Length Control	Variable	S2LC	00
	Fixed		01
Set Length	Length 1 (or Min Length) from 1 to 50 characters	S2L1	v
	Length 2 (or Max Length) 0 or from 1 to 50 characters	S2L2	v
Check Options			
Check Calculation	Disable	S2CC	00
	Enable		01
Check Tx	Disable	S2CT	00
	Enable		01
Decoding Options			
Minimum Reads	One Read	S2MR	01
	Two Reads		02
	Three Reads		03
	Four Reads		04
Decoding Level	Disable	S2DL	00
	Level 1		01
	Level 2		02
	Level 3		03
	Level 4		04
	Level 5		05
Character Correlation	Disable	S2CO	00
	Enable		01
Stitching	Disable	S2ST	00
	Enable		01
Industrial 2 of 5			
Industrial 2 of 5	Disable	U2EN	00
	Enable		01
Code Length Control	Variable	U2LC	00
	Fixed		01
Set Length	Length 1 (or Min Length) from 1 to 50 characters	U2L1	v
	Length 2 (or Max Length) 0 or from 1 to 50 characters	U2L2	v
Check Options			
Check Calculation	Disable	U2CC	00
	Enable		01

v = Hex value from **00** or **02** to **32** representing the decimal number

CODE SELECTION			
Description		Parameter	Value
Check Tx	Disable	U2CT	00
	Enable		01
Decoding Options			
Minimum Reads	One Read	U2MR	01
	Two Reads		02
	Three Reads		03
	Four Reads		04
Character Correlation	Disable	U2CO	00
	Enable		01
Stitching	Disable	U2ST	00
	Enable		01
IATA			
IATA	Disable	IAEN	00
	Enable		01
Check Tx	Disable	IACT	00
	Enable		01
Datalogic 2 of 5			
Datalogic 2 of 5	Disable	D2EN	00
	Enable		01
Code Length Control	Variable	D2LC	00
	Fixed		01
Set Length	Length 1 (or Min Length) from 1 to 50 characters	D2L1	v
	Length 2 (or Max Length) 0 or from 1 to 50 characters	D2L2	v
Check Options			
Check Calculation	Disable	D2CC	00
	Enable		01
Check Tx	Disable	D2CT	00
	Enable		01
Decoding Options			
Minimum Reads	One Read	D2MR	01
	Two Reads		02
	Three Reads		03
	Four Reads		04
Decoding Level	Disable	D2DL	00
	Level 1		01
	Level 2		02
	Level 3		03

v = Hex value from **00** or **02** to **32** representing the decimal number

CODE SELECTION			
Description		Parameter	Value
	Level 4		04
	Level 5		05
Character Correlation	Disable	D2CO	00
	Enable		01
Stitching	Disable	D2ST	00
	Enable		01
Codabar			
Codabar	Disable	CBEN	00
	Enable		01
Code Length Control	Variable	CBLC	00
	Fixed		01
Set Length	Length 1 (or Min Length) from 3 to 50 characters	CBL1	v
	Length 2 (or Max Length) 0 or from 3 to 50 characters	CBL2	v
ABC Codabar			
ABC Codabar	Disable	CBAB	00
	Enable		01
Concatenation Mode	Static	CBCM	00
	Dynamic		01
Dynamic Concat. Timeout	From 50 to 2550 ms	CBDT	t
Check Options			
Check Calculation	Disable	CBCC	00
	Enable AIM Standard Check		01
	Enable Mod-10 Check		02
Check Tx	Disable	CBCT	00
	Enable		01
Start/Stop Set	ABCD/TN*E	CBSC	00
	ABCD/ABCD		01
	abcd/tn*e		02
	abcd/abcd		03
Start/Stop Tx	Disable	CBSS	00
	Enable		01
Start/Stop Match	Disable	CBSM	00
	Enable		01
Decoding Options			
Minimum Reads	One Read	CBMR	01
	Two Reads		02

v = Hex value from 00 or 02 to 32 representing the decimal number

t = Hex value from 05 to FF representing the decimal number ($\times 10$ ms)

CODE SELECTION			
Description		Parameter	Value
	Three Reads		03
	Four Reads		04
Decoding Level	Disable	CBDL	00
	Level 1		01
	Level 2		02
	Level 3		03
	Level 4		04
	Level 5		05
Character Correlation	Disable	CBCO	00
	Enable		01
Interdigit Ratio	Any ratio or 1 to 10	CBIR	<i>r</i>
Quiet Zones	Quiet Zone on One Side	CBLO	01
	Quiet Zones on Two Sides		02
	Auto		03
	Virtual Quiet Zones on Two Sides		04
	Small Quiet Zones on Two Sides		05
Stitching	Disable	CBST	00
	Enable		01
GS1 Databar Omnidirectional			
GS1 Databar Omnidirectional	Disable	4BEN	00
	Enable		01
GS1-128 Emulation	Disable	4BU8	00
	Enable		01
Omnidirectional Decoding Options			
Minimum Reads	One Read	4BMR	01
	Two Reads		02
	Three Reads		03
	Four Reads		04
GS1 Databar Expanded			
GS1 Databar Expanded	Disable	XBEN	00
	Enable		01
GS1-128 Emulation	Disable	XBU8	00
	Enable		01
Code Length Control	Variable	XBLC	00
	Fixed		01

r = Hex value from 00 to 0A representing the decimal number of the interdigit space/module ratio (00 = any ratio)

CODE SELECTION			
Description		Parameter	Value
Set Length	Length 1 (or Min Length) from 1 to 74 characters	XBL1	w
	Length 2 (or Max Length) 0 or from 1 to 74 characters	XBL2	w
Expanded Decoding Options			
Minimum Reads	One Read	XBMR	01
	Two Reads		02
	Three Reads		03
	Four Reads		04
Coupon Control	Allow all coupon barcodes to be decoded	CPCL	00
	Enable only UPC-A coupon decoding		01
	Enable only GS1 Databar coupon decoding		02
GS1 Databar Limited			
GS1 Databar Limited	Disable	LBEN	00
	Enable		01
GS1-128 Emulation	Disable	LBU8	00
	Enable		01
Limited Decoding Options			
Minimum Reads	One Read	LBMR	01
	Two Reads		02
	Three Reads		03
	Four Reads		04
Code 93			
Code 93	Disable	C9EN	00
	Enable		01
Code Length Control	Variable	C9LC	00
	Fixed		01
Set Length	Length 1 (or Min Length) from 1 to 50 characters	C9L1	v
	Length 2 (or Max Length) 0 or from 1 to 50 characters	C9L2	v
Check Options			
Check Calculation	Disable	C9CC	00
	Enable Check C		01
	Enable Check K		02
	Enable Check C and K		03
Check Tx	Disable	C9CT	00
	Enable		01
Decoding Options			
Minimum Reads	One Read	C9MR	01

w = Hex value from **00** to **4A** representing the decimal number

v = Hex value from **00** or **02** to **32** representing the decimal number

CODE SELECTION			
Description		Parameter	Value
	Two Reads		02
	Three Reads		03
	Four Reads		04
Decoding Level	Disable	C9DL	00
	Level 1		01
	Level 2		02
	Level 3		03
	Level 4		04
	Level 5		05
Character Correlation	Disable	C9CO	00
	Enable		01
Quiet Zones	No Quiet Zones	C9LO	00
	Quiet Zone on One Side		01
	Quiet Zones on Two Sides		02
	Auto		03
	Virtual Quiet Zones on Two Sides		04
Stitching	Disable	C9ST	00
	Enable		01
MSI			
MSI	Disable	MSEN	00
	Enable		01
Code Length Control	Variable	MSLC	00
	Fixed		01
Set Length	Length 1 (or Min Length) from 1 to 50 characters	MSL1	v
	Length 2 (or Max Length) 0 or from 1 to 50 characters	MSL2	v
Check Options			
Check Calculation	Disable	MSCC	00
	Enable Mod 10		01
	Enable Mod 11/10		02
	Enable Mod 10/10		03
Check Tx	Disable	MSCT	00
	Enable		01
Decoding Options			
Minimum Reads	One Read	MSMR	01
	Two Reads		02
	Three Reads		03
	Four Reads		04

v = Hex value from 00 or 02 to 32 representing the decimal number

CODE SELECTION			
Description		Parameter	Value
Decoding Level	Disable	MSDL	00
	Level 1		01
	Level 2		02
	Level 3		03
	Level 4		04
	Level 5		05
Stitching	Disable	MSST	00
	Enable		01
Plessey			
Plessey	Disable	PLEN	00
	Enable		01
Code Length Control	Variable	PLLC	00
	Fixed		01
Set Length	Length 1 (or Min Length) from 1 to 50 characters	PLL1	v
	Length 2 (or Max Length) 0 or from 1 to 50 characters	PLL2	v
Check Options			
Check Calculation	Disable	PLCC	00
	Standard		01
	Anker Calculation		02
	Standard and Anker Calculation		03
Check Tx	Disable	PLCT	00
	Enable		01
Decoding Options			
Minimum Reads	One Read	PLMR	01
	Two Reads		02
	Three Reads		03
	Four Reads		04
Decoding Level	Disable	PLDL	00
	Level 1		01
	Level 2		02
	Level 3		03
	Level 4		04
	Level 5		05
Character Correlation	Disable	PLCO	00
	Enable		01
Stitching	Disable	PLST	00
	Enable		01

v = Hex value from **00** or **02** to **32** representing the decimal number

NOTES

Chapter 5

References

This section contains explanations and examples of selected barcode features. See the Configuration section for the actual barcode labels used to configure the reader.

RS-232 Parameters

RS-232 Only

Baud Rate

Baud rate is the number of bits of data transmitted per second. Set the reader's baud rate to match the baud rate setting of the host device. With an improper baud rate setting, data may not reach the host correctly.

Stop Bits

The stop bit(s) at the end of each transmitted character marks the end of transmission of one character and prepares the receiving device for the next character in the serial data stream. The number of stop bits selected (one or two) depends on the number the receiving terminal is programmed to accommodate. Set the number of stop bits to match host device requirements.

Parity

This feature specifies parity required for sending and receiving data. A parity check bit is the most significant bit of each ASCII coded character. Select the parity type according to host device requirements.

- Select None when no parity bit is required.
- Select Odd parity and the parity bit value is set to 0 or 1, based on data, to ensure that an odd number of 1 bits are contained in the coded character.
- Select Even parity and the parity bit value is set to 0 or 1, based on data, to ensure that an even number of 1 bits are contained in the coded character.

Handshaking Control

The data interface consists of an RS-232 port designed to operate either with or without the hardware handshaking lines, *Request to Send* (RTS), and *Clear to Send* (CTS). Handshaking Control includes the following options:

- RTS — RTS is asserted during transmissions. CTS is ignored.
- RTS/CTS — RTS is asserted during transmissions. CTS gates transmissions.

- RTS/XON/XOFF — RTS is asserted during transmissions. CTS is ignored. XON and XOFF gate transmissions.
- RTS On/CTS — RTS is always asserted. CTS gates transmissions.

RTS/CTS Scan Control — RTS is asserted during transmissions. CTS gates transmissions and controls enable and disable state of scanner.

RS-232/USB COM Parameters

Intercharacter Delay

This parameter specifies the intercharacter delay between the end of one character and the beginning of the next. The delay can be set within a range of zero (0) to 990 milliseconds in 10ms increments. A setting of zero specifies no delay.

To set the delay:

1. Determine the desired setting in milliseconds.
2. Divide the desired setting by 10 (setting is in 10ms increments). Pad the result with leading zeroes to yield two digits. For example: 0 = 00, 5 = 05, 20 = 20, etc.
3. Scan the ENTER/EXIT PROGRAMMING MODE barcode to enter Programming Mode.
4. Go to [page 27](#) and scan the barcode: SELECT INTERCHARACTER DELAY SETTING.
5. Scan the appropriate two digits from the keypad in [Appendix D, Keypad](#), that represent the duration which was determined in the steps above. You will hear a two-beep indication after the last character.



If you make a mistake before the last character, scan the CANCEL barcode to abort and not save the entry string. You can then start again at the beginning.

6. Scan the ENTER/EXIT PROGRAMMING MODE barcode to exit.

This completes the procedure. See [Table 24](#) for some examples of how to set this feature.

Table 24. Intercharacter Delay Setting Examples

STEP	ACTION	EXAMPLES			
1	Desired Setting	50ms	150ms	600ms	850ms
2	Divide by 10 (pad with leading zeroes to yield two-digits)	05	15	60	85
3	Scan ENTER/EXIT PROGRAMMING MODE				
4	Scan SELECT INTERCHARACTER DELAY SETTING				
5	Scan Two Characters From Appendix D, Keypad	'0' and '5'	'5' and '0'	'6' and '0'	'8' and '5'
6	Scan ENTER/EXIT PROGRAMMING MODE				

ACK NAK Options

This enables/disables the ability of the reader to support the RS-232 ACK/NAK protocol. When configured, the reader and/or host sends an “ACK” when it receives data properly, and sends “NAK” when the data is in error.

Options are:

- Disable
- Enable for label transmission — The reader expects an ACK/NAK response from the host when a label is sent.
- Enable for host-command acknowledge — The reader will respond with ACK/NAK when the host sends a command.
- Enable for label transmission and host-command acknowledge



The ACK/NAK Characters must be different and must not contain reserved characters (see Appendix E, Reserved Characters).

ACK Character

This setting specifies an ASCII character or hex value to be used as the ACK character. ASCII characters or any hex value from 0 to 0xFF can be selected.



Setting to previously defined characters such as XON, XOFF, or host commands conflicts with normal operation of these characters. 8-bit data is not recognized when the option Data Bits has been set as 7 Data Bits.

1. Determine the desired character or value. Use the [ASCII Chart](#) on the inside back cover of this manual to find the hex equivalent for the desired character/value.
2. Go to [page 29](#) and scan ENTER/EXIT PROGRAMMING MODE to enter Programming Mode.
3. Scan the barcode: SELECT ACK CHARACTER SETTING.
4. Scan the appropriate two alpha-numeric characters from the keypad in [Appendix D, Keypad](#), that represent the desired character/value in step 1 above. The second character will cause a two-beep indication.
5. Scan the ENTER/EXIT PROGRAMMING MODE barcode to exit.

Table 25. ACK Character Setting Examples

STEP	ACTION	EXAMPLES			
1	Desired Character/Value	ACK	\$	@	>
2	Hex equivalent from ASCII Chart	0x06	0x24	0x40	0x3E
3	Scan ENTER/EXIT PROGRAMMING MODE				
4	Scan SELECT ACK CHARACTER SETTING				
5	Scan Two Characters from Appendix D, Keypad	'0' and '6'	'2' and '4'	'4' and '0'	'3' AND 'E'
6	Scan ENTER/EXIT PROGRAMMING MODE				

NAK Character

This setting specifies an ASCII character or hex value to be used as the NAK character. ASCII characters or any hex value from 0 to 0xFF can be selected.



Setting to previously defined characters such as XON, XOFF, or host commands conflicts with normal operation of these characters. 8-bit data is not recognized when the option [Data Bits](#) has been set as 7 Data Bits.

To set this feature:

1. Determine the desired character or value.
2. Use the [ASCII Chart](#) on the inside back cover of this manual to find the hex equivalent for the desired character/value.
3. Go to [page 29](#) and scan the ENTER/EXIT PROGRAMMING MODE barcode to enter Programming Mode.
4. Scan the barcode: SELECT NAK CHARACTER SETTING.
5. Scan the appropriate two alpha-numeric characters from the keypad in [Appendix D, Keypad](#), that represent the desired character/value in step 1 above. The second character will cause a two-beep indication.
6. Scan the ENTER/EXIT PROGRAMMING MODE barcode to exit Programming Mode.

This completes the procedure. See [Table 26](#) for some examples of how to set this feature.

Table 26. NAK Character Setting Examples

STEP	ACTION	EXAMPLES			
1	Desired Character/Value	NAK	\$	@	>
2	Hex equivalent from ASCII Chart	0x15	0x24	0x40	0x3E
3	Scan ENTER/EXIT PROGRAMMING MODE				
4	Scan SELECT ACK CHARACTER SETTING				
5	Scan Two Characters From Appendix D, Keypad	'1' and '5'	'2' and '4'	'4' and '0'	'3' AND 'E'
6	Scan ENTER/EXIT PROGRAMMING MODE				

ACK NAK Timeout Value

This option specifies the amount of time the reader waits for an ACK character from the host following label transmission. The selectable timeout range is 200 milliseconds to 15,000ms (15 seconds) in 200ms increments. A selection of 0 disables the timeout.

To set this value:

1. Determine the desired setting in milliseconds.
2. Divide the desired setting by 200 (setting is in 200ms increments). Pad the result with leading zeroes to yield two digits. For example: 0 = 00, 5 = 05, 20 = 20, etc.
3. Go to [page 30](#) and scan the ENTER/EXIT PROGRAMMING MODE barcode to enter Programming Mode.
4. Scan the barcode: SELECT ACK NAK TIMEOUT VALUE SETTING.
5. Scan the appropriate two digits from the keypad in [Appendix D, Keypad](#), that represent the duration which was determined in the steps above. You will hear a two-beep indication after the last character.



If you make a mistake before the last character, scan the CANCEL barcode to abort and not save the entry string. You can then start again at the beginning.

6. Scan the ENTER/EXIT PROGRAMMING MODE barcode to exit Programming Mode.

This completes the procedure. See [Table 27](#) for some examples of how to set this feature.

Table 27. ACK NAK Timeout Value Setting Examples

STEP	ACTION	EXAMPLES			
1	Desired Setting	200ms	1,000ms (1 sec.)	5200ms (5.2 sec.)	15,000ms (15 sec.)
2	Divide by 200	01	05	26	75
3	Scan ENTER/EXIT PROGRAMMING MODE				
4	Scan SELECT ACK NAK TIMEOUT VALUE SETTING				
5	Scan Two Characters From Appendix D, Keypad	'0' and '1'	'0' and '5'	'2' and '6'	'7' and '5'
6	Scan ENTER/EXIT PROGRAMMING MODE				

ACK NAK Retry Count

This feature specifies the number of times the reader retries a label transmission due to a retry condition. The selectable range is from 1 to 254 retries. A selection of 0 disables the count, and a selection of 255 specifies unlimited retries.

To set this feature:

1. Determine the desired setting.
2. Pad the number with leading zeroes to yield three digits. For example: 0 = 000, 5 = 005, 20 = 020, etc.
3. Go to [page 30](#) and scan the ENTER/EXIT PROGRAMMING MODE barcode to enter Programming Mode.
4. Scan the barcode: SELECT ACK NAK RETRY COUNT SETTING.
5. Scan the appropriate three digits from the keypad in [Appendix D, Keypad](#), that represent the number which was determined in the steps above. You will hear a two-beep indication after the last character.



If you make a mistake before the last character, scan the CANCEL barcode to abort and not save the entry string. You can then start again at the beginning.

6. Scan the ENTER/EXIT PROGRAMMING MODE barcode to exit Programming Mode.

This completes the procedure. See [Table 28](#) for some examples of how to set this feature.

Table 28. ACK NAK Retry Count Setting Examples

STEP	ACTION	EXAMPLES			
1	Desired Setting	Disable Retry Count	3 Retries	54 Retries	Unlimited Retries
2	Pad with leading zero(es)	000	003	054	255
3	Scan ENTER/EXIT PROGRAMMING MODE				
4	Scan SELECT ACK NAK RETRY COUNT SETTING				
5	Scan Three Characters From Appendix D, Keypad	'0', '0' and '0'	'0', '0' and '3'	'0', '5' and '4'	'2', '5' and '5'
6	Scan ENTER/EXIT PROGRAMMING MODE				

Disable Character

Specifies the value of the RS-232 host command used to disable the reader.

ASCII characters or any hex value from 0 to 0xFF can be selected.



Setting to previously defined characters such as XON, XOFF, or host commands conflicts with normal operation of these characters. 8-bit data is not recognized when the option Data Bits has been set as 7 Data Bits.

To set the value:

1. Determine the desired character or value. A setting of 0xFF indicates the Disable Character is not used (not available).
2. Use the [ASCII Chart](#) on the inside back cover of this manual to find the hex equivalent for the desired character/value.
3. Go to [page 32](#) and scan the ENTER/EXIT PROGRAMMING MODE barcode to enter Programming Mode.
4. Scan the barcode: SELECT DISABLE CHARACTER SETTING.
5. Scan the appropriate two alpha-numeric characters from the keypad in [Appendix D, Keypad](#), that represent the desired character/value in step 1 above. The second character will cause a two-beep indication.
6. Scan the ENTER/EXIT PROGRAMMING MODE barcode to exit Programming Mode.

This completes the procedure. See [Table 29](#) for some examples of how to set this feature.

Table 29. Disable Character Setting Examples

STEP	ACTION	EXAMPLES			
1	Desired character/value	'd'	'}'	'D'	Disable Command Not Used
2	Hex equivalent from ASCII Chart	0x64	0x7D	0x44	0xFF
3	Scan ENTER/EXIT PROGRAMMING MODE				
4	Scan SELECT DISABLE CHARACTER VALUE SETTING				
5	Scan Two Characters From Appendix D, Keypad	'6' and '4'	'7' and 'D'	'4' and '4'	'F' AND 'F'
6	Scan ENTER/EXIT PROGRAMMING MODE				



The Enable/Disable Characters must be different and must not contain reserved characters (see [Appendix E, Reserved Characters](#))

Enable Character

Specifies the value of the RS-232 host command used to enable the reader.

ASCII characters or any hex value from 0 to 0xFF can be selected.



Setting to previously defined characters such as XON, XOFF, or host commands conflicts with normal operation of these characters. 8-bit data is not recognized when the option [Data Bits](#) has been set as 7 Data Bits.

To set this feature:

Determine the desired character or value. A setting of 0xFF indicates the Enable Character is not used (not available).

1. Determine the desired character or value.
2. Use the [ASCII Chart](#) on the inside back cover of this manual to find the hex equivalent for the desired character/value.
3. Go to [page 32](#) and scan the ENTER/EXIT PROGRAMMING MODE barcode to enter Programming Mode.
4. Scan the barcode: SELECT ENABLE CHARACTER SETTING.
5. Scan the appropriate two alpha-numeric characters from the keypad in [Appendix D, Keypad](#), that represent the desired character/value in step 2 above. The second character will cause a two-beep indication.
6. Scan the ENTER/EXIT PROGRAMMING MODE barcode to exit Programming Mode.

This completes the procedure. See [Table 30](#) for some examples of how to set this feature.

Table 30. Enable Character Setting Examples

STEP	ACTION	EXAMPLES			
1	Desired character/value	'e'	'}'	'E'	Enable Command Not Used
2	Hex equivalent from ASCII Chart	0x65	0x7D	0x45	0xFF
3	Scan ENTER/EXIT PROGRAMMING MODE				
4	Scan SELECT DISABLE CHARACTER VALUE SETTING				
5	Scan Two Characters From Appendix D, Keypad	'6' and '5'	'7' and 'D'	'4' and '5'	'F' AND 'F'
6	Scan ENTER/EXIT PROGRAMMING MODE				

Data Editing

When a barcode is scanned, additional information can be sent to the host computer along with the barcode data. This combination of barcode data and supplementary user-defined data is called a “message string.” The Data Editing features can be used to build specific user-defined data into a message string.

There are several types of selectable data characters that can be sent before and after scanned data. You can specify if they should be sent with all symbologies, or only with specific symbologies. Figure 3 shows the available elements you can add to a message string:

Figure 3. Breakdown of a Message String

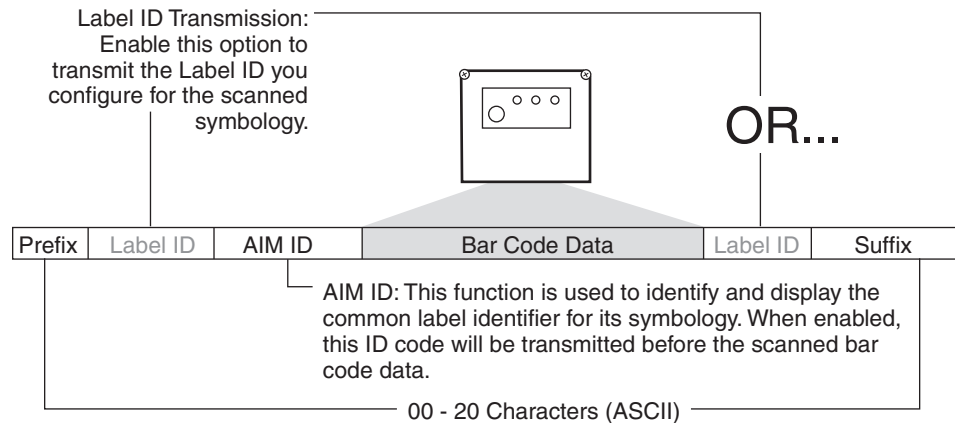

Additional advanced editing is available. See the Advanced formatting features in the Datalogic Aladdin configuration software, or contact Technical Support (described on page 8 for more information).

Please Keep In Mind...

- Modifying a message string is not a mandatory requirement. Data editing is a sophisticated feature allowing highly customizable output for advanced users. Factory default settings for data editing is typically set to NONE.
- A prefix or suffix may be applied only to a specified symbology (reference [Code Selection, starting on page 77](#)) or across all symbologies (set via the Global features in this chapter).
- You can add any character from the [ASCII Chart](#) (from 00-FF) on the inside back cover of this manual as a prefix, suffix or Label ID.
- Enter prefixes and suffixes in the order in which you want them to appear on the output.

Global Prefix/Suffix

Up to 20 ASCII characters may be added as a prefix (in a position before the barcode data) and/or as a suffix (in a position following the barcode data) as indicated in Figure 4.

Figure 4. Prefix and Suffix Positions

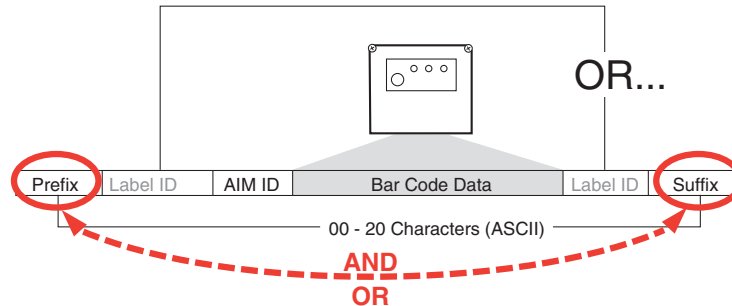

Example: Setting a Prefix

In this example, we'll set a prefix for all symbologies.

1. Determine which ASCII character(s) are to be added to scanned barcode data. In this example, we'll add a dollar sign ('\$') as a prefix.
2. Go to [page 42](#) and scan the ENTER/EXIT PROGRAMMING MODE barcode.
3. Scan the SET GLOBAL PREFIX barcode.
4. Reference the [ASCII Chart](#) on the inside back cover of this manual to find the hex value assigned to the desired character. The corresponding hex number for the '\$' character is 24. To enter this selection code, scan the '2' and '4' barcodes from [Appendix D, Keypad](#).



If you make a mistake before the last character, scan the CANCEL barcode to abort and not save the entry string. You can then start again at the beginning.

5. If less than the expected string of 20 characters are selected, scan the ENTER/EXIT barcode to terminate the string.
6. Scan the ENTER/EXIT barcode once again to exit Programming Mode.
7. The resulting message string would appear as follows:

Scanned barcode data: **12345**

Resulting message string output: **\$12345**

Global AIM ID



This feature enables/disables addition of AIM IDs for all symbology types.

AIM label identifiers (as opposed to custom characters you select yourself as with label identifiers) can be included with scanned barcode data. AIM label identifiers consist of three characters as follows:

- A close brace character (ASCII '['), followed by...
- A code character (see the table below), followed by...
- A modifier character (the modifier character is symbol dependent).

SYMBOLGY	CHAR	SYMBOLGY	CHAR
UPC/EAN	E ^a	Code 128/GS1-128	C
Code 39 and Code 32	A	DataBar Omnidirectional, DataBar Expanded	e
Codabar	F	Standard 2 of 5	S
Interleaved 2 of 5	I	ISBN	X ^b
Code 93	G	Code 11	H

- a. UPC-A and UPC-E labels are converted to EAN 13 when adding AIM IDs.
 b. ISBN (X with a 0 modifier character)

Figure 5. AIM ID

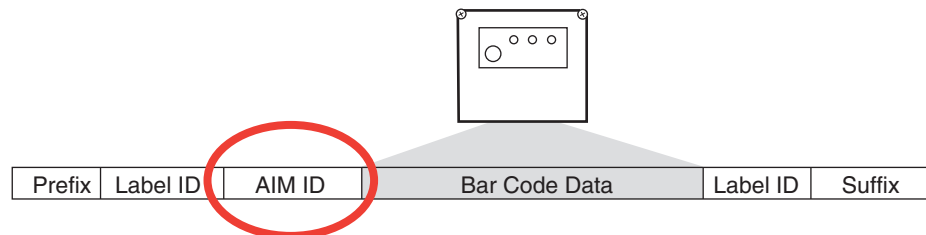

Label ID

A Label ID is a customizable code of up to three ASCII characters (each can be one of hex 0x01-0xFF), used to identify a barcode (symbology) type. It can be appended previous to or following the transmitted barcode data depending upon how this option is enabled. This feature provides options for configuring custom Label IDs as a pre-loaded set (see "Label ID: Pre-loaded Sets" below) or individually per symbology (see "Label ID: Set Individually Per Symbology" on page 246). If you wish to program the reader to always include an industry standard label identifier for ALL symbology types, see "Global AIM ID" on page 43.

Label ID: Pre-loaded Sets

The reader supports two pre-loaded sets of Label IDs. Table 31 shows the USA and the EU sets.



CAUTION

When changing from one Label ID set to another, all other reader configuration settings, including the host interface type, will be erased and set to the standard factory defaults. Any custom configuration or custom defaults will be lost.

Table 31. Label ID Pre-loaded Sets

Symbology	USA Label ID set		EU Label ID set	
	ASCII character	Hexadecimal value	ASCII character	Hex i decimal value
ABC Codabar	S	530000	S	530000
Anker Plessey	o	6F0000	o	6F0000
CODABAR	%	250000	R	520000
CODE128	#	230000	T	540000
CODE32	A	410000	X	580000
CODE39	*	2A0000	V	560000
CODE39 CIP	Y	590000	Y	590000
CODE93	&	260000	U	550000
DATALOGIC 2OF5	s	730000	s	730000
EAN13	F	460000	B	420000
EAN13 P2	F	460000	L	4C0000
EAN13 P5	F	460000	M	4D0000
EAN8	FF	464600	A	410000
EAN8 P2	FF	464600	J	4A0000
EAN8 P5	FF	464600	K	4B0000

Label ID Pre-Loaded Sets (continued)

Symbology	USA Label ID set		EU Label ID set	
	ASCII character	Hexadecimal value	ASCII character	Hexadecimal value
GS1 DATABAR EXPANDED	RX	525800	t	740000
GS1 DATABAR LIMITED	RL	524C00	v	760000
GS1 DATABAR OMNIDIRECTIONAL	R4	523400	u	750000
GS1-128		000000	k	6B0000
GTIN	G	470000	\$A	244100
GTIN2	G2	473200	\$B	244200
GTIN5	G5	473500	\$C	244300
IATA	IA	494100	&	260000
Industrial 2 of 5	W	570000	W	570000
Interleaved 2 of 5	i	690000	N	4E0000
ISBN	l	490000	@	400000
ISBT128	f	660000	f	660000
ISSN	n	6E0000	n	6E0000
MSI	@	400000	Z	5A0000
Plessey	a	610000	a	610000
S25	s	730000	P	500000
UPCA	A	410000	C	430000
UPCA P2	A	410000	F	460000
UPCA P5	A	410000	G	470000

Label ID: Set Individually Per Symbology

To configure a Label ID individually for a single symbology:

1. Go to [page 45](#) and scan the ENTER/EXIT barcode.
2. Select Label ID position as either BEFORE (Enable as Prefix) or AFTER (Enable as suffix) by scanning the appropriate barcode in the section "[Label ID Control](#)" on [page 45](#). Reference [Figure 6](#) for Label ID positioning options if multiple identification features are enabled.
3. Scan a barcode to select the symbology for which you wish to configure a custom Label ID from the section "[Label ID Symbology Selection](#)" on [page 46](#).
4. Determine the desired character(s) (you may choose up to three) which will represent the Label ID for the selected symbology.
5. Turn to the [ASCII Chart](#) on the inside back cover of this manual and find the equivalent hex digits associated with your choice of Label ID. For example, if you wish to select an equal sign (=) as a Label ID, the chart indicates its associated hex characters as 3D. Turn to [Keypad](#), starting on [page 277](#) and scan the barcodes representing the hex characters determined. For the example given, the characters '3' and 'D' would be scanned. More examples of Label ID settings are provided in [Table 32](#).



If you make a mistake before the last character, scan the CANCEL barcode to abort and not save the entry string. You can then start again at the beginning.

6. Scan the ENTER/EXIT barcode to exit Label ID entry.
7. Scan the ENTER/EXIT barcode once again to exit Programming Mode.

This completes the steps to configure a Label ID for a given symbology.

Figure 6. Label ID Position Options

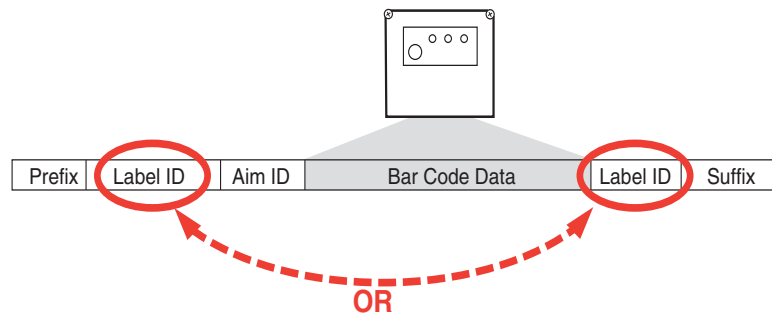

Table 32. Label ID Examples

STEP	ACTION	EXAMPLES			
1.	Scan the ENTER/EXIT barcode	(Scanner enters Programming Mode)			
2.	<p>Determine placement of the Label ID characters BEFORE or AFTER with regard to scanned data using Label ID Control, starting on page 45</p>	Enable as Prefix	Enable as Suffix	Enable as Prefix	Enable as Suffix
3.	<p>Scan the barcode selecting the symbology type you wish to designate label ID characters for using Label ID Symbology Selection, starting on page 46.</p>	DataBar Omnidirectional	Code 39	Interleaved 2 of 5	Code 32
4.	<p>Custom Label ID example (desired characters):</p>	D B *	= C 3	+	P H
5.	<p>Find hex equivalents from the ASCII Chart (inside back cover), then scan in these digits/characters using the barcodes in the section: Keypad, starting on page 277. If you make a mistake before the last character, scan the CANCEL barcode to abort and not save the entry string. You can then start again at the beginning.</p>	44 42 2A	3D 43 33	2B	50 48
6.	Scan the ENTER/EXIT barcode	(Scanner exits Label ID entry)			
7.	Scan the ENTER/EXIT barcode once again	(Scanner exits Programming Mode)			
Result:		DB*[barcode data]	[barcode data]=C3	+[barcode data]	[barcode data]PH

Character Conversion

Character conversion is an eight byte configuration item. The eight bytes are 4 character pairs represented in hexadecimal ASCII values. The first character in the pair is the character that will be converted. The second character in the pair is the character to convert to. If the character to convert in a pair is FF, then no conversion is done.

For example, if you have the character conversion configuration item set to the following: 41423132FFFFFFFF

The first pair is 4142 or AB (41 hex is an ASCII capital A, 42 hex is an ASCII capital B) and the second pair is 3132 or 12 (31 hex is an ASCII 1, 32 is an ASCII 2). The other two pairs are FFFF and FFFF.

With the label, AB12BA21, it would look as follows after the character conversion: BB22BB22.

The A characters were converted to B characters and the 1 characters were converted to 2 characters. Nothing is done with the last two character pairs, since they are all FF.

To set Character Conversion:

1. Go to [page 55](#) and scan the ENTER/EXIT barcode.
2. Scan the “Configure Character Conversion” barcode.
3. Determine the desired string. Sixteen positions must be determined as in the above example. Next, turn to the [ASCII Chart](#) on the inside back cover of this manual and find the equivalent hex digits needed to fulfill the string.
4. Turn to [Appendix D, Keypad](#) and scan the barcodes representing the hex characters determined in the previous step.
5. Scan the ENTER/EXIT barcode to exit Programming Mode.



If less than the expected string of 16 characters is selected, scan the ENTER/EXIT barcode twice to accept the selections and exit Programming Mode.

Scanner Data Formatting Control

No Read String

This feature allows the transmission of a programmable character or string when no code has been decoded (No read) during a reading phase (On Line Mode only).

To set this feature:

1. Determine the desired character string (maximum 20).
2. Reference the ASCII Chart on the inside back cover of this manual to find the hex value assigned to the desired character.
3. Go to [No Read String on page 51](#) and scan ENTER/EXIT PROGRAMMING MODE to enter Programming Mode

4. Scan the barcode: "Select No Read String."
5. Scan the hex equivalent characters from the keypad in Appendix D that represent the desired character string in step 1 above.
6. If less than the expected string of 20 characters is selected, scan the ENTER/EXIT barcode to terminate the string.
7. Scan the ENTER/EXIT PROGRAMMING MODE barcode once again to exit Programming Mode.

This completes the procedure.

Code Verifier

Code Verifier is available in On Line or Serial On Line and Automatic modes only. A programmable character or string is transmitted after a successful reading phase depending on the result of a comparison between the decoded label and a user specified label.

Code Verifier Mode

Options for this feature are:

- **Disable:** disable the Code Verifier functionality
- **Transmit Wrong String:** the reader will transmit the wrong string to the Host.
- **Transmit Wrong Code:** the reader will transmit the wrong code to the Host.

If the code read matches the code verifier Match String then it is sent to the host through the configured port. If it does not match the code verifier Match String, either the Wrong Code can be sent or the defined Wrong String message can be sent indicating the error.

Match String

The string used as the match code for code verification. The Match String must be configured to include start/stop characters and check digits, if their transmission is enabled.

It is possible to define the Match string by inserting:

- any printable characters
- non-printable ASCII characters available in the list inside the parameter edit box

No wild card characters are supported.

To set this feature:

1. Determine the desired character string (max 32).
2. Reference the ASCII Chart on the inside back cover of this manual to find the hex value assigned to the desired character.
3. Go to [Match String on page 53](#) and scan ENTER/EXIT PROGRAMMING MODE to enter Programming Mode.
4. Scan the barcode: SELECT MATCH STRING.
5. Turn to [Appendix D, Keypad](#) and scan the barcodes representing the hex characters determined in step 1 above.
6. If less than the expected string of 32 characters are selected, scan the ENTER/EXIT barcode to terminate the string.

7. Scan the ENTER/EXIT PROGRAMMING MODE barcode to exit Programming Mode.

This completes the procedure.

Wrong Code String

The string sent in case of a mismatch (wrong code read).

To set this feature:

1. Determine the desired character string (max 20).
2. Reference the ASCII Chart on the inside back cover of this manual to find the hex value assigned to the desired character.
3. Go to [Wrong Code String on page 54](#) and scan ENTER/EXIT PROGRAMMING MODE to enter Programming Mode.
4. Scan the barcode: SELECT WRONG CODE STRING.
5. Turn to [Appendix D, Keypad](#) and scan the barcodes representing the hex characters determined in step 1 above.
6. If less than the expected string of 20 characters are selected, scan the ENTER/EXIT barcode to terminate the string.
7. Scan the ENTER/EXIT PROGRAMMING MODE barcode to exit Programming Mode.

This completes the procedure.

Label Transmit Mode

Specifies whether the decoded label must be transmitted over the host interface as it has been decoded or after the reading phase has been deactivated (phase off). This does not apply to Test Mode.

Reading Parameters

Illumination Mode

This feature allows you to select the illumination mode for the reader. The illumination mode can be used to:

- increase the overall diode life
- reduce power consumption
- turn off the illuminator for safety purposes

Selections:

- Disabled: the illuminator is always off
- Enabled: the illuminator is always on
- Triggered: the illuminator is turned on when the reading phase starts. The illuminator is turned off as soon as the code(s) are read or when the reading phase ends.



The triggered selection is ignored for Automatic and Test Operating Modes.

Good Read LED Duration

This feature specifies the amount of time that the Good Read LED remains on following a good read. The good read LED on time can be set within a range of 100 milliseconds to 25,500 milliseconds (0.1 to 25.5 seconds) milliseconds in 100ms increments.

Follow these instructions to set this feature:

1. Determine the desired setting in milliseconds. A setting of 0 means that the good read LED stays on until the next time the trigger is pulled.
2. Divide the desired setting by 100 (setting is in 100ms increments). Pad the result with leading zeroes to yield three digits. For example: 0 = 000, 5 = 005, 20 = 020, etc.
3. Go to [page 69](#) and scan the ENTER/EXIT PROGRAMMING MODE barcode to enter Programming Mode.
4. Scan the barcode: SELECT GOOD READ LED DURATION SETTING.
5. Scan the appropriate three digits from the keypad in [Appendix D, Keypad](#) representing the duration which was determined in the steps above. You will hear a two-beep indication after the last character.



If you make a mistake before the last character, scan the CANCEL barcode to abort and not save the entry string. You can then start again at the beginning.

6. Scan the ENTER/EXIT PROGRAMMING MODE barcode to exit Programming Mode.

This completes the procedure. See [Table 33](#) for some examples of how to set this feature.

Table 33. Good Read LED Duration Setting Examples

STEP	ACTION	EXAMPLES			
1	Desired Setting	Good Read LED stays on until next trigger pull (00)	20ms	150ms	2550ms (2.55 sec.)
2	Divide by 10 (and pad with leading zeroes)	000	002	015	255
3	Scan ENTER/EXIT PROGRAMMING MODE				
4	Scan LABEL GOOD READ LED DURATION				
5	Scan Three Characters From Appendix D, Keypad	'0', '0' and '0'	'0', '0' and '2'	'0', '1' and '5'	'2', '5' and '5'
6	Scan ENTER/EXIT PROGRAMMING MODE				

Scanning Features

Operating Mode

The following Operating Modes (Reading Modes) are supported:

On Line

In On Line mode, the reading phase is defined as the time between the Phase ON and Phase OFF events. The Phase events can be generated by an external input (trigger) or by the Trigger button. While in this mode the scanner activates reading only during a reading phase. The Phase events can be signals coming from the trigger button (or external presence sensor connected to the scanner input for RS232 models).

On Line mode allows the following configurations:

Phase Off Event: Specifies whether the reading phase is closed on a timeout or phase off event. The following selections are available:

- Trigger Stop: the reading phase ends when the trigger event stops. Timeout is disabled.
- Timeout: the reading phase ends when the timeout is expired. Trigger stop is ignored.
- Trigger Stop - Timeout: the reading phase ends when the first event occurred.

Timeout: Specifies the maximum duration for the reading phase. Selections: from 40 to 5100 ms in 20 ms increments

Serial On Line

In Serial On Line mode, a reading phase is defined as the time between two events: phase on and phase off, generated by a message sent from the host interface to the scanner. While in this mode the scanner activates reading only during a reading phase. The message (character or string) is user programmable.

Serial On Line mode configurations:

Serial Start Character (or String): Specifies the string message to be sent over the host interface to activate the reading phase

Serial Stop Character (or String): Specifies the string message to be sent over the host interface to stop the reading phase.



The Serial Start/Stop Characters must be different and must not contain reserved characters (see Appendix E, Reserved Characters).

Phase Off Event: Specifies whether the reading phase is closed on a timeout or phase off event.

The following selections are available:

- Trigger Stop: the reading phase ends when the serial stop character (or string) is received. Timeout is disabled.
- Timeout: the reading phase ends when the timeout is expired. Serial stop character (or string) is ignored.
- Trigger Stop - Timeout: the reading phase ends when the first event occurred.

Timeout: Specifies the maximum duration for the reading phase. Selections: from 40 to 5100 ms in 20 ms increments.

Automatic

In Automatic mode, the scanner is continuously scanning. When a label enters the reading zone and is decoded, no more decodes and reading phases are allowed until the label has left the reading area. In order to guarantee identification of the code in the reading zone, a threshold specifies the number of scans after the successful decode that the scanner will wait before rearming the reading phase. The transmission of the decoded label depends on the configuration of the Transmission Mode parameter.

Automatic mode configurations:

Automatic Threshold: Specifies the number of “empty” scans allowed after decoding a label, before the scanner switches back to a new reading phase.

Automatic/Trigger Object Sense

Automatic/TOS mode is the same as Automatic mode, but with the lighting system OFF. As an object or barcode enters the reading area, the light is turned ON. The light will return OFF as the reading phase is closed (see Automatic Mode above).



While in Trigger Object Sense Mode the green spot stays on while in stand watch state.

Test Mode

Test Mode reports information about the reading performance of the reader, and the code is continuously read. After 100 scans, the following information is transmitted to the Host:

- The code content
- Percentage of good reads. If the good read percentage is 0, no transmission occurs.

The information can be displayed on the Host PC by running a terminal emulator program such as HyperTerminal. The output data format is fixed.

Test Mode Multiple

This parameter is active only while the scanner is in Test mode:

- Disable: Test mode is possible only for a single barcode
- Enable: Test mode is possible for one or more barcodes at the same time

Camera Control

Exposure Mode

Controls the lighting system mode. Camera lighting system can be set to low power or to high power (Strobed Mode), depending on the user application. When set in Strobed Mode the scanner controls the camera parameters dynamically in order to guarantee best performances with high speed applications and extreme external light conditions.

Parameters:

- Continuous Mode: Lighting LEDs are activated with a 150mA current
- Strobed Mode: Lighting LEDs are activated with a 750mA current.
- Implementation details: Scan rate is fixed to 3,25 msec. An automatic algorithm will be implemented in order to fulfil the dynamic reading performances required.

Special Recipes

Special Recipes allow the user to select the best combination for reading parameters according to the specific application (i.e. Code Color, Code Contrast, Code Resolution).

Power Save

USB Suspend

Enables or disables USB Suspend Mode.



This feature is available only for GFS4170 model (USB interface).

Suspend Mode enables the reader to enter low-power mode if no bus activity is detected, typically when the Host PC goes into Standby mode. All LED indicators are off during Suspend Mode, and the reader power consumption is less than 2.5 mA. The reader wakes up automatically when it detects bus activity.

This feature is disabled by default.

Sleep Mode Timeout

Specifies the timeout value for the reader to enter low-power mode (Sleep).



This feature is available only for GFS4150-9 (RS232 interface) in On Line operating mode.

The reader wakes up when receiving an input signal or trigger button press.

The reader cannot connect to Aladdin when in sleep mode.

Default is 00 (Disable).

Digital Output

Output Activation:

Digital Output can set to be Activated/Deactivated when specified events occur.

Line State: Selects whether the line is Active Low or Active High.

Activation Event: Selects the event the line is activated on. Selectable events: Disabled, Good Read, No Read, Right Code, Wrong Code. Right Code and Wrong Code are available only if Code Verifier functionality is enabled.

Deactivation Event: Selects the event the line is deactivated on. Selectable events: Disabled, Timeout, Reading Phase On.

Deactivation Timeout: Related to the previous parameter, sets the deactivation timeout for the output.

Symbologies

Decoding Level

Decoding Levels are used to configure a barcode symbology decoder to be very aggressive to very conservative depending on a particular customer's needs.

- Level 1 results in a very conservative decoder at the expense of not being able to read poorly printed or damaged labels.
- Level 5 results in a very aggressive decoder. This aggressive behavior allows decoding of poorly printed and damaged labels at the expense of increasing the likelihood of decoding errors.
- Level 3, which is the default setting, allows the majority of product labels to be decoded.

There are many factors that determine when to change the decoding level for a particular symbology. These factors include spots, voids, non-uniform bar/space widths, damaged labels, etc. that may be experienced in some barcode labels. If there are many hard to read or damaged labels that cannot be decoded using a conservative setting, increase the decoding level to be more aggressive. If the majority of labels are very good quality labels, or there is a need to decrease the possibility of a decoder error, lower the decoding level to a more conservative level.

Set Length

Length Control allows you to select either variable length decoding or fixed length decoding for the specified symbology.

Variable Length. For variable length decoding, a minimum and maximum length may be set.

Fixed Length. For fixed length decoding, two different lengths may be set.

Set Length 1

This feature specifies one of the barcode lengths for Length Control. Length 1 is the minimum label length if in Variable Length Mode, or the first fixed length if in Fixed Length Mode. Length includes the barcode's data characters only.

The number of characters that can be set varies, depending on the symbology. Reference the page for your selected symbology to see specific variables.

1. Determine the desired character length (varies depending on symbology). Pad the number with leading zeroes to yield two digits. For example: 0 = 00, 5 = 05, 20 = 20, etc.
2. Go to the Set Length page for your selected symbology and scan the ENTER/EXIT PROGRAMMING MODE barcode to enter Programming Mode.
3. Scan the barcode to SELECT LENGTH 1 SETTING for your selected symbology.
4. Scan the appropriate two digits from the keypad in [Appendix D, Keypad](#), that represent the length setting which was determined in the steps above. You will hear a two-beep indication after the last character.



If you make a mistake before the last character, scan the CANCEL barcode to abort and not save the entry string. You can then start again at the beginning.

5. Scan the ENTER/EXIT PROGRAMMING MODE barcode to exit Prog Mode.

Set Length 2

This feature allows you to set one of the barcode lengths for the specified symbology. Length 2 is the maximum label length if in [Variable Length Mode](#), or the second fixed length if in [Fixed Length Mode](#). See the page for the specific symbology for parameters.

The length that can be set varies depending on the symbology. A setting of 0 specifies to ignore this length (only one fixed length).

Follow these instructions to set this feature:

1. Determine the desired character length (from 1 to 50 — or 0 to ignore this length). Pad the number with leading zeroes to yield two digits. For example: 0 = 00, 5 = 05, 20 = 20, etc.
2. Go to the Set Length page for your selected symbology and scan the ENTER/EXIT PROGRAMMING MODE barcode to enter Programming Mode.
3. Scan the barcode to SELECT LENGTH 2 SETTING for your selected symbology.
4. Scan the appropriate two digits from the keypad in [Appendix D, Keypad](#) that represent the length setting which was determined in the steps above. You will hear a two-beep indication after the last character.



If you make a mistake, before the last character scan the CANCEL barcode to abort and not save the entry string. You can then start again at the beginning.

5. Scan the ENTER/EXIT PROGRAMMING MODE barcode to exit Programming Mode.

This completes the procedure.

Appendix A

Technical Specifications

Table 34 contains Physical and Performance Characteristics, User Environment and Regulatory information.

Table 34. Technical Specifications

Item	Description
Physical Characteristics	
Color	Grey
Dimensions	Height 1.54" / 39mm Length 2.24" / 57mm Width 2.28" / 58 mm
Weight (without cable and brackets)	USB model - Approx. 5.0 ounces/140 g RS-232 model - approx. 6.0 ounces/170 g
Electrical Characteristics	
Input Voltage	5 VDC \pm 5%
External Trigger Input	5 \div 30 VDC (Only GFS4150-9)
Output	V _{max} = 30VDC (Only GFS4150-9)
Current & Power Consumption	Input current at 5V = 390 mA (max) < 2.5 mA (GFS4170 model in USB suspend)
Performance Characteristics	
Scan rate	320 scans/s (max)
Light Source	Dual LEDs (Red Light, \approx 620 nm)
Roll Angle Tolerance	\pm 35°
Pitch Angle Tolerance	\pm 65° (Avoid zero angle, \pm 6°)
Skew Angle Tolerance	\pm 65°
Depth of Field (Typical)	5 mil - 2" to 6.3" (5cm to 16cm) 8 mil - 1.2" to 10.6" (3cm to 27cm) 13 mil* - 1.2" to 15.7" (3cm to 40 cm) 20 mil - up to 23.6" (up to 60 cm)
Minimum Element Width	3 mil
Print Contrast Minimum	15% minimum reflectance

Item	Description
Decode Capability	UPC/EAN/JAN A, E, 13, 8 (including P2 /P5, ISBN / Bookland & ISSN); Code 39 (including full ASCII); Code 39 CIP (French Pharmaceutical); Code 128; I 2 of 5; Standard 2 of 5; China Post Code (DLS 2 of 5); IATA Industrial 2 of 5 Air Cargo Code; Codabar; ABC Codabar; GS1 - 128; Code ISBT 128; MSI; Plessey; DATABAR-14; DATABAR Limited; DATABAR-14 Stacked; DATABAR Expanded Stacked; Code32 (Italian Pharmacode); China Post (DLS 2 of 5).
Interfaces Supported	GFS4150-9 model: RS-232 Standard GFS4170 model: USB COM Standard, USB Keyboard
User Environment	
Operative Temperature	32° to 122° F (0° to 50° C)
Storage Temperature	-13° to 158° F (-25° to 70° C)
Humidity	Operating: 5% to 90% relative humidity, non condensing
Drop specifications	5 drops from 30 inches (0.76 mt.) to concrete
Ambient Light immunity	Up to 100,000 Lux
Contaminants	IP54
ESD Level	16 KV
Regulatory	See the Quick Reference Guide for each specific product for details.

* (13 mils DOF based on EAN. All others are Code 39. All labels grade A, minimum illumination 100 lux, 20°C, label inclination 10°, static reading).

Standard Cable Pinouts

RS-232 Electrical Connections

9-pin connector

1	Trigger	Trigger signal input (see Figure 36 and Figure 37 below)
2	TX	Transmit Data
3	RX	Receive Data
4	NC	Not connected
5	GND	Ground
6	VCC	+5Vdc
7	CTS	Clear To Send
8	RTS	Request To Send
9	OUT	Output signal (see Figure 35 below)

Default configuration RS-232: 9600, 8, N, 1, no handshaking, ACK/NAK disabled.

Figure 35. Output Connection

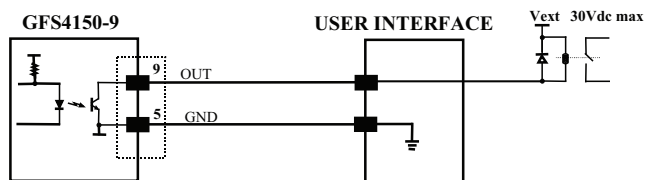

Figure 36. Using GFS4150-9 Power

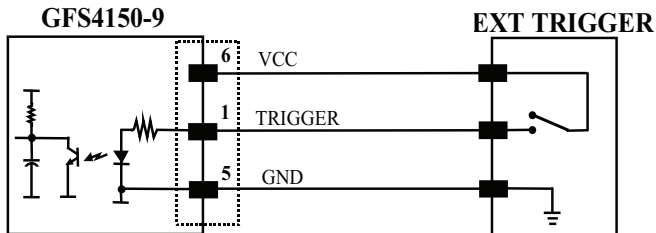
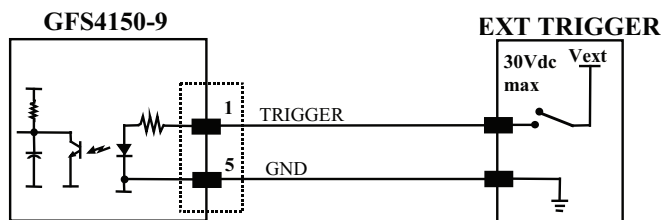



Figure 37. Using External Power Supply



LED and Beeper Indications

Button and LED Status

The top of the product has a button and three indicator LEDs:

	POWER (yellow LED)	ON = Power ON OFF = Power OFF or standby (only USB model)
	GOOD (green LED)	ON = Good Read Blinks = USB enumeration or interface inactive or waiting for change of configuration
		TRIGGER (blue LED)
	Button	Press for manual trigger

The reader's beeper sounds and its LED illuminates to indicate various functions or errors on the reader. An optional "Green Spot" also performs useful functions. The tables below list these indications. One exception to the behaviors listed in the tables is that the reader's functions are programmable, and may or may not be turned on. For example, certain indications such as the power-up beep can be disabled using programming barcode labels.

Table 38. LED and Beeper Indications

INDICATION	DESCRIPTION	LED	BEEPER
Power-up Beep	The reader is in the process of powering-up.		Reader beeps four times at highest frequency and volume upon power-up.
Good Read Beep	A label has been successfully scanned by the reader.	LED behavior for this indication is configurable via the feature "Good Read: When to Indicate"	The reader will beep once at current frequency, volume, mono/bi-tonal setting and duration upon a successful label scan.
ROM Failure	There is an error in the reader's software/programming	Flashes	Reader sounds one error beep at highest volume.
Limited Scanning Label Read	Indicates that a host connection is not established when the USB interface is enabled.	N/A	Reader 'chirps' six times at the highest frequency and current volume.
Reader Active Mode	The reader is active and ready to scan.	The Green LED is lit steadily ^a	N/A
Reader Disabled	The reader has been disabled by the host.	The Green LED blinks continuously	N/A
Green Spot is on continuously	While in Object Sense Mode, the green spot stays on while in stand watch state.	N/A	N/A

INDICATION	DESCRIPTION	LED	BEEPER
Green Spot ^a flashes momentarily	Upon successful read of a label, the software shall turn the green spot on for the time specified by the configured value.	N/A	N/A

a. Except when in sleep mode or when a **Good Read LED Duration** other than 00 is selected

Table 39. Programming Mode Indications

Programming Mode - The following indications ONLY occur when the reader is in Programming Mode.

Label Programming Mode Entry	A valid programming label has been scanned.	Green LED blinks continuously	Reader sounds four low frequency beeps.
Label Programming Mode Rejection of Label	A label has been rejected.	N/A	Reader sounds three times at lowest frequency & current volume.
Label Programming Mode Acceptance of Partial Label	In cases where multiple labels must be scanned to program one feature, this indication acknowledges each portion as it is successfully scanned.	N/A	Reader sounds one short beep at highest frequency & current volume.
Label Programming Mode Acceptance of Programming	Configuration option(s) have been successfully programmed via labels and the reader has exited Programming Mode.	N/A	Reader sounds one high frequency beep and 4 low frequency beeps followed by reset beeps.
Label Programming Mode Cancel Item Entry	Cancel label has been scanned.	N/A	Reader sounds two times at low frequency and current volume.

Error Codes

Upon startup, if the reader sounds a long tone, this means the reader has not passed its automatic Selftest and has entered FRU (Field Replaceable Unit) isolation mode. If the reader is reset, the sequence will be repeated. The following table describes the LED flashes/beep codes associated with an error found.

NUMBER OF LED FLASHES/BEEPS	ERROR	CORRECTIVE ACTION
1	Configuration	Contact Helpdesk for assistance
2	Interface PCB	
4	Reader Module	
6	Digital PCB	
14	CPLD/Code Mismatch	

NOTES

Appendix B

Standard Defaults

The most common configuration settings are listed in the “Default” column of the table below. Page references are also provided for feature descriptions and programming barcodes for each parameter. A column has also been provided for recording of your preferred default settings for these same configurable features.

Table 40. Standard Defaults

Parameter	Default	Your Setting	Page Number
GLOBAL INTERFACE FEATURES			
Host Commands — Obey/Ignore	Obey		19
RS-232 ONLY			
Baud Rate	9600		22
Data Bits	8 Data Bits		23
Stop Bits	1 Stop Bit		23
Parity	None		24
Handshaking Control	Disable		25
RS-232/USB-COM			
Intercharacter Delay	No Delay		27
Beep On ASCII BEL	Disable		27
Beep On Not on File	Enable		28
ACK Character	‘ACK’		29
NAK Character	‘NAK’		29
ACK NAK Timeout Value	200 ms		30
ACK NAK Retry Count	3 Retries		30
ACK NAK Error Handling	Ignore Errors Detected		31

Parameter	Default	Your Setting	Page Number
Indicate Transmission Failure	Enable		31
Disable Character	'D'		32
Enable Character	'E'		32
USB KEYBOARD			
Country Mode	U.S. Keyboard		34
Send Control Characters	Disable		37
USB Keyboard Speed	1 ms		38
DATA FORMAT			
Global Prefix/Suffix	No Global Prefix Global Suffix = 0x0D (CR)		42
Global AIM ID	Disable		43
GS1-128 AIM ID	Enable		44
Label ID: Pre-loaded Sets	USA Set		44
Label ID Control	Disable		45
Label ID Symbology Selection			46
Set Global Mid Label ID Characters	No Mid Label ID Character		50
No Read String	0x18 = [CAN]		51
Code Verifier Mode	Disabled		52
Match String			53
Wrong Code String			54
Case Conversion	Disable		54
Character Conversion	No Char Conversion		55
DIGITAL OUTPUT			
Activation Event	Disable		58
Deactivation Event	Disable		59
Deactivation Timeout	005 = 500 msec		59
Activation State	Closed		60
POWER SAVE			
USB Suspend Mode	Disable		62
Sleep Mode Timeout	00		63

Parameter	Default	Your Setting	Page Number
READING PARAMETERS			
Illumination Mode	Triggered		66
Power On Alert	Enable		66
Good Read: When to Indicate	On Decode		67
Good Read Beep	Enable		67
Good Read Beep Length	100 ms		68
Good Read LED Duration	100 ms		69
Green Spot Duration	300 ms		70
LED Indication	On Decode		70
Operating Mode	On Line		71
Phase Off Event	Trigger Stop		72
Phase Off Timeout	100 = Timeout set on for 2 seconds		72
Serial Start Character	0x02 = Serial Start Character is [02 STX]		73
Serial Stop Character	0x03 = Serial Stop Character is [03 ETX]		73
Automatic Threshold	0x0A = 10		74
Test Mode Multiple	Disable		74
Exposure Mode	Continuous		75
CODE SELECTION			
Coupon Control	Enable UPCA coupon decoding		79
UPC-A			
UPC-A Enable/Disable	Enable		80
UPC-A Check Character Transmission	Enable		80
Expand UPC-A to EAN-13	Disable		81
UPC-A Number System Character Transmission	Transmit		81
UPC-A Minimum Reads	1		82
UPC-E			
UPC-E Enable/Disable	Enable		83
UPC-E Check Character Transmission	Send		83
Expand UPC-E to EAN-13	Disable		84

Parameter	Default	Your Setting	Page Number
Expand UPC-E to UPC-A	Disable		84
UPC-E Number System Character Transmission	Transmit		85
UPC-E Minimum Reads	2		85
GTIN			
GTIN Formatting	Disable		86
EAN 13 (Jan 13)			
EAN 13 Enable/Disable	Enable		87
EAN 13 Check Character Transmission	Send		87
EAN-13 Flag 1 Character	Transmit		88
EAN-13 ISBN Conversion	Disable		88
EAN 13 Minimum Reads	1		89
ISSN			
ISSN Enable/Disable	Disable		90
EAN 8			
EAN 8 Enable/Disable	Enable		91
EAN 8 Check Character Transmission	Send		91
Expand EAN 8 to EAN 13	Disable		92
EAN 8 Minimum Reads	1		92
UPC/EAN Global Settings			
UPC/EAN Decoding Level	3		93
UPC/EAN Correlation	Disable		94
UPC/EAN Price Weight Check	Disable		94
In-Store Minimum Reads	2		95
Add-Ons			
Optional Add-ons	Disable P2, P5 and P8		96
Optional Add-On Timer	70 ms		97
Optional GS1-128 Add-On Timer	Disable		100
P5 Add-Ons Minimum Reads	1		104
Code 39			
Code 39 Enable/Disable	Enable		106
Code 39 Check Character Calculation	Calculate		106

Parameter	Default	Your Setting	Page Number
Code 39 Check Character Transmission	Send		107
Code 39 Start/Stop Character Transmission	Don't Transmit		108
Code 39 Full ASCII	Disable		108
Code 39 Quiet Zones	Auto		109
Code 39 Minimum Reads	2		110
Code 39 Decoding Level	3		111
Code 39 Length Control	Variable		112
Code 39 Set Length 1	2		113
Code 39 Set Length 2	50		114
Code 39 Interdigit Ratio	4		115
Code 39 Character Correlation	Disable		117
Code 39 Stitching	Enable		117
Code 32 (Italian Pharmaceutical Code)			
Code 32 Enable/Disable	Disable		118
Code 32 Feature Setting Exceptions	N/A		118
Code 32 Check Char Transmission	Don't Send		119
Code 32 Start/Stop Character Transmission	Don't Transmit		119
Code 39 CIP (French Pharmaceutical Code)			
Code 39 CIP Enable/Disable	Disable		118
Code 128			
Code 128 Enable/Disable	Enable		121
Expand Code 128 to Code 39	Disable		121
Code 128 Check Character Transmission	Send		122
Code 128 Function Character Transmission	Disable		122
Code 128 Sub-Code Change Transmission	Disable		123
Code 128 Quiet Zones	Auto		124
Code 128 Minimum Reads	1		125
Code 128 Decoding Level	3		126
Code 128 Length Control	Variable		127
Code 128 Set Length 1	1		128
Code 128 Set Length 2	80		129

Parameter	Default	Your Setting	Page Number
Code 128 Character Correlation	Disable		130
Code 128 Stitching	Enable		130
GS1-128			
GS1-128 Enable	Transmit in Code 128 Data Format		131
ISBT 128			
ISBT 128 Concatenation	Disable		132
ISBT 128 Concatenation Mode	Static		132
ISBT 128 Dynamic Concatenation Timeout	200 msec		133
ISBT 128 Advanced Concatenation Options	Disable		133
Interleaved 2 of 5			
1 2 of 5 Enable/Disable	Disable		134
1 2 of 5 Check Character Calculation	Disable		134
1 2 of 5 Check Character Transmission	Send		135
1 2 of 5 Minimum Reads	2		156
2 of 5 Decoding Level	3		156
1 2 of 5 Length Control	Variable		138
1 2 of 5 Set Length 1	6		139
1 2 of 5 Set Length 2	50		140
1 2 of 5 Character Correlation	Disable		141
1 2 of 5 Stitching	Disable		141
Standard 2 of 5			
Standard 2 of 5 Enable/Disable	Disable		142
Standard 2 of 5 Check Character Calculation	Disable		142
Standard 2 of 5 Check Character Transmission	Send		143
Standard 2 of 5 Minimum Reads	2		143
Standard 2 of 5 Decoding Level	3		144
Standard 2 of 5 Length Control	Variable		144
Standard 2 of 5 Set Length 1	8		145
Standard 2 of 5 Set Length 2	50		146
Standard 2 of 5 Character Correlation	Disable		147
Standard 2 of 5 Stitching	Disable		147

Parameter	Default	Your Setting	Page Number
Industrial 2 of 5			
Industrial 2 of 5 Enable/Disable	Disable		148
Industrial 2 of 5 Check Character Calculation	Disable		148
Industrial 2 of 5 Check Character Transmission	Enable		149
Industrial 2 of 5 Length Control	Variable		149
Industrial 2 of 5 Set Length 1	1		150
Industrial 2 of 5 Set Length 2	50		151
Industrial 2 of 5 Minimum Reads	1		152
Industrial 2 of 5 Stitching	Disable		153
Industrial 2 of 5 Character Correlation	Disable		152
Code IATA			
IATA Enable/Disable	Disable		154
IATA Check Character Transmission	Enable		154
Datalogic 2 of 5			
Datalogic 2 of 5 Enable/Disable	Disable		155
Datalogic 2 of 5 Check Character Calculation	Disable		155
Datalogic 2 of 5 Minimum Reads	2		156
Datalogic 2 of 5 Decoding Level	3		156
Datalogic 2 of 5 Length Control	Variable		157
Datalogic 2 of 5 Set Length 1	6 characters		158
Datalogic 2 of 5 Set Length 2	50		159
Datalogic 2 of 5 Character Correlation	Disable		160
Datalogic 2 of 5 Stitching	Disable		160
Codabar			
Codabar Enable/Disable	Disable		161
Codabar Check Character Calculation	Don't Calculate		161
Codabar Check Character Transmission	Send		162
Codabar Start/Stop Character Transmission	Transmit		162
Codabar Start/Stop Character Set	abcd/abcd		163
Codabar Start/Stop Character Match	Don't Require Match		163
Codabar Quiet Zones	Auto		164

Parameter	Default	Your Setting	Page Number
Codabar Minimum Reads	2		165
Codabar Decoding Level	3		166
Codabar Length Control	Variable		166
Codabar Set Length 1	3		168
Codabar Set Length 2	50		169
Codabar Interdigit Ratio	4		170
Codabar Character Correlation	Disable		172
Codabar Stitching	Disable		172
ABC Codabar			
ABC Codabar Enable/Disable	Disable		173
ABC Codabar Concatenation Mode	Static		173
ABC Codabar Dynamic Concatenation Timeout	200 msec		174
GS1 DataBar™ Omnidirectional			
GS1 DataBar™ Omnidirectional Enable/Disable	Disable		175
GS1 DataBar™ Omnidirectional GS1-128 Emulation	Disable		175
GS1 DataBar™ Omnidirectional Minimum Reads	1		176
GS1 DataBar™ Expanded			
GS1 DataBar™ Expanded Enable/Disable	Disable		177
GS1 DataBar™ Expanded GS1-128 Emulation	Disable		177
GS1 DataBar™ Expanded Minimum Reads	1		178
GS1 DataBar™ Expanded Length Control	Variable		178
GS1 DataBar™ Expanded Set Length 1	1		179
GS1 DataBar™ Expanded Set Length 2	74		180
GS1 DataBar™ Limited			
GS1 DataBar™ Limited Enable/Disable	Disable		181
GS1 DataBar™ Limited GS1-128 Emulation	Disable		181
GS1 DataBar™ Limited Minimum Reads	1		182
Code 93			
Code 93 Enable/Disable	Disable		183
Code 93 Check Character Calculation	Enable Check C and K		183
Code 93 Check Character Transmission	Disable		184

Parameter	Default	Your Setting	Page Number
Code 93 Length Control	Variable		184
Code 93 Set Length 1	1		185
Code 93 Set Length 2	50		186
Code 93 Minimum Reads	1		187
Code 93 Decoding Level	3		188
Code 93 Quiet Zones	Auto		189
Code 93 Stitching	Enable		190
Code 93 Character Correlation	Enable		190
MSI			
MSI Enable/Disable	Disable		191
MSI Check Character Calculation	Enable Mod10		191
MSI Check Character Transmission	Enable		192
MSI Length Control	Variable		193
MSI Set Length 1	1		193
MSI Set Length 2	50		194
MSI Minimum Reads	4		195
MSI Decoding Level	3		196
MSI Stitching	Disable		197
MSI Character Correlation	Disable		197
Plessey			
Plessey Enable/Disable	Disable		198
Plessey Check Character Calculation	Enable Plessey std. check char. verification		199
Plessey Check Character Transmission	Enable		199
Plessey Length Control	Variable		200
Plessey Set Length 1	1		201
Plessey Set Length 2	50		202
Plessey Minimum Reads	4		203
Plessey Decoding Level	3		204
Plessey Stitching	Disable		205
Plessey Character Correlation	Disable		205

NOTES

Appendix C

Sample Barcodes

The sample barcodes in this appendix are typical representations for their symbology types.



UPC-A



EAN-13

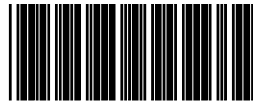

Code 39

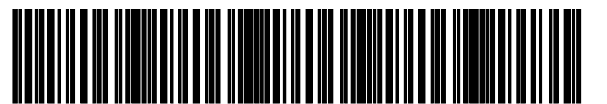

Code 128



Interleaved 2 of 5

Sample Barcodes — continued



A020096020

Code 32



057654850

Codabar



12345678

Code 93



7554628485801

Code 11

GS1 DataBar™ (RSS)



GS1 DataBar™ variants must be enabled to read the barcodes below (see [GS1 DataBar™ Omnidirectional](#) on page 175).



10293847560192837465019283746029478450366523
(GS1 DataBar™ Expanded Stacked)



1234890hjo9900mnb
(GS1 DataBar™ Expanded)



08672345650916
(GS1 DataBar™ Limited)

GS1 DataBar™-14



55432198673467
(GS1 DataBar™ Omnidirectional Truncated)



90876523412674
(GS1 DataBar™ Omnidirectional Stacked)









78123465709811
(GS1 DataBar™ Omnidirectional Stacked)

NOTES

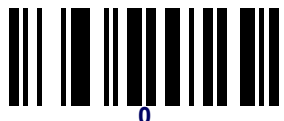
Appendix D

Keypad

Use the barcodes in this appendix to enter numbers as you would select digits/characters from a keypad.

 0	
	 1
 2	
	 3
 4	
	 5



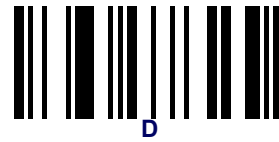

NOTES

Appendix E

Reserved Characters

Reserved Characters	Hex Value	Notes
[SOH]	0x01	
[BEL]	0x07	
#	0x23	
\$	0x24	
0	0x30	
3	0x33	
B	0x42	
D	0x44	
E	0x45	
F	0x46	
R	0x52	
S	0x53	
h	0x68	
i	0x69	
s	0x73	
t	0x74	
[FF]	0xFF	
Reserved Strings		
C<up to 36 chars>[CR]	0x43 <xxx> 0x0D	C can be used without [CR] or inside a string (not the first character)
01[CR]	0x30 0x31 0x0D	
34[CR]	0x33 0x34 0x0D	

NOTES

Appendix F

Scancode Tables

Control Character Emulation

Control character emulation selects from different scancode tables as listed in this appendix. Each of the control character sets below are detailed by interface type in the tables. These apply to USB Keyboard platforms.

Control Character 00 . Characters from 00 to 0x1F are sent as control character Ctrl+Keys, special keys are located from 0x80 to 0xA1.

Control Character 01 . Characters from 00 to 0x1F are sent as control character Ctrl+Capital Key, special keys are located from 0x80 to 0xA1.

Control Character 02 . Special keys are located from 00 to 0x1F and characters from 0x80 to 0xFE are intended as an extended ASCII table (Microsoft Windows Codepage 1252 — See page 288).

Single Press and Release Keys

In the following tables, Ar↓ means Alt right pressed and Ar↑ means Alt right released and so on. Definitions for other keys are Al (Alt left), Cr (Control Right) Cl (Control Left) Sh (shift). This method can be used for combining Alt, Control or Shift with other keys.

Example: Consider a Control character set to 00. If AltRight+A is required before sending a label to the host, it could be done by setting three Prefix keys in this way: 0x99 0x41 0x9A.

Interface Type USB-Keyboard or USB-Keyboard for APPLE

Table 41. Scancode Set When Control Character is 00 or 01

	x0	x1	x2	x3	x4	x5	x6	x7	x8	x9	xA	xB	xC	xD	xE	xF
0x	NULL C+@	SOH C(S)+A	STX C(S)+B	ETX C(S)+C	EOT C(S)+D	ENQ C(S)+E	ACK C(S)+F	BEL C(S)+G	BS HT TAB	LF C(S)+J	VT C(S)+K	FF C(S)+L	CR Enter	SO C(S)+N	SI C(S)+O	
1x	DLE C(S)+P	DC1 C(S)+Q	DC2 C(S)+R	DC3 C(S)+S	DC4 C(S)+T	NAK C(S)+U	SYN C(S)+V	ETB C(S)+W	CAN C(S)+X	EM C(S)+Y	SUB C(S)+Z	ESC Esc	FS C+\	GS C+]	RS C+^	US C(S)+_
2x	<u>SP</u>	!	"	#	\$	%	&	'	()	*	±	.	=	-	/
3x	<u>0</u>	<u>1</u>	<u>2</u>	<u>3</u>	<u>4</u>	<u>5</u>	<u>6</u>	<u>7</u>	<u>8</u>	<u>9</u>	:	:	≤	≡	≥	?
4x	<u>@</u>	<u>A</u>	<u>B</u>	<u>C</u>	<u>D</u>	<u>E</u>	<u>F</u>	<u>G</u>	<u>H</u>	<u>I</u>	<u>J</u>	<u>K</u>	<u>L</u>	<u>M</u>	<u>N</u>	<u>O</u>
5x	<u>P</u>	<u>Q</u>	<u>R</u>	<u>S</u>	<u>T</u>	<u>U</u>	<u>V</u>	<u>W</u>	<u>X</u>	<u>Y</u>	<u>Z</u>	[\]	^	_
6x	<u>`</u>	<u>a</u>	<u>b</u>	<u>c</u>	<u>d</u>	<u>e</u>	<u>f</u>	<u>g</u>	<u>h</u>	<u>i</u>	<u>j</u>	<u>k</u>	<u>l</u>	<u>m</u>	<u>n</u>	<u>o</u>
7x	<u>p</u>	<u>q</u>	<u>r</u>	<u>s</u>	<u>t</u>	<u>u</u>	<u>v</u>	<u>w</u>	<u>x</u>	<u>y</u>	<u>z</u>	{		}	~	<i>Del</i>
8x	€	Sh↓	Sh↑	Ins	Ent (keyp)	F1	F2	F3	F4	F5	F6	F7	F8	F9	F10	F11
9x	F12	Home	End	Pg Up	Pg Dwn	↑	↓	←	→	Ar↓	Ar↑	Al↓	Al↑	Cl↓	Cl↑	Cr↓
Ax	Cr↑	□	‘	f	„	...	†	‡	^	%	Š	<	Š	<	Œ	□
Bx	°	±	²	³	´	µ	¶	·	,	¹	º	»	¼	½	¾	¿
Cx	À	Á	Â	Ã	Ä	Å	Æ	Ç	È	É	Ê	Ë	Ì	Í	Î	Ï
Dx	Ð	□	Ò	Ó	Ô	Õ	Ö	×	Ø	Ù	Ú	Û	Ü	Ý	Þ	ß
Ex	à	á	â	ã	ä	å	æ	ç	è	é	ê	ë	ì	í	î	ï
Fx	ð	ñ	ò	ó	ô	õ	ö	÷	ø	ù	ú	û	ü	ý	þ	ÿ

Extended characters (sky blue) are sent through dedicated keys (when available in the selected country mode) or by using an Alt Mode sequence.

Interface Type USB-Keyboard or USB-Keyboard for APPLE — cont.

Table 42. Scancode Set When Control Character is 02

	x0	x1	x2	x3	x4	x5	X6	x7	x8	x9	xA	xB	xC	xD	xE	xF
0x	Ar↓	Ar↑	Al↓	Al↑	Cl↓	Cl↑	Cr↓	Cr↑	BS	Tab	→	S+ Tab	Enter Keyprd	Enter	Ins	Pg Up
1x	Pg Dwn	Home	←	↓	↑	F6	F1	F2	F3	F4	F5	ESC	F7	F8	F9	F10
2x	Space	!	“	#	\$	%	&	‘	()	*	+	,	-	.	/
3x	0	1	2	3	4	5	6	7	8	9	:	;	<	=	>	?
4x	@	A	B	C	D	E	F	G	H	I	J	K	L	M	N	O
5x	P	Q	R	S	T	U	V	W	X	Y	Z	[\]	^	_
6x	`	a	b	c	d	e	f	g	h	i	j	k	l	m	n	o
7x	p	q	r	s	t	u	v	w	x	y	z	{		}	~	Del
8x	€	□	‘	f	„	…	†	‡	^	%	Š	<	Š	<	Œ	□
9x	□	‘	’	“	”	•	–	—	~	™	š	>	œ	□	ž	ÿ
Ax	NBSP	ı	ç	£	¤	¥	¦	§	¨	©	ª	«	¬	-	®	¯
Bx	°	±	²	³	´	µ	¶	·	,	¹	º	»	¼	½	¾	¿
Cx	À	Á	Â	Ã	Ä	Å	Æ	Ç	È	É	Ê	Ë	Ì	Í	Î	Ï
Dx	Ð	□	Ò	Ó	Ô	Õ	Ö	×	Ø	Ù	Ú	Û	Ü	Ý	Þ	ß
Ex	à	á	â	ã	ä	å	æ	ç	è	é	ê	ë	ì	í	î	ï
Fx	ð	ñ	ò	ó	ô	õ	ö	÷	ø	ù	ú	û	ü	ý	þ	ÿ

Interface type USB-Keyboard Alt Mode

Table 43. Scancode Set When Control Character is 00 or 01

	x0	x1	x2	x3	x4	x5	X6	x7	x8	x9	xA	xB	xC	xD	xE	Xf
0x	Alt+000	Alt+001	Alt+002	Alt+003	Alt+004	Alt+005	Alt+006	Alt+007	BS	HT TAB	Alt+010	Alt+011	Alt+012	CR Enter	Alt+014	Alt+015
1x	Alt+016	Alt+017	Alt+018	Alt+019	Alt+020	Alt+021	Alt+022	Alt+023	Alt+024	Alt+025	Alt+026	ESC Esc	Alt+028	Alt+029	Alt+030	Alt+031
2x	A+032	A+033	A+034	A+035	A+036	A+037	A+038	A+039	A+040	A+041	A+042	A+043	A+044	A+045	A+046	A+047
3x	A+048	A+049	A+050	A+051	A+052	A+053	A+054	A+055	A+056	A+057	A+058	A+059	A+060	A+061	A+062	A+063
4x	A+064	A+065	A+066	A+067	A+068	A+069	A+070	A+071	A+072	A+073	A+074	A+075	A+076	A+077	A+078	A+079
5x	A+080	A+081	A+082	A+083	A+084	A+085	A+086	A+087	A+088	A+089	A+090	A+091	A+092	A+093	A+094	A+095
6x	A+096	A+097	A+098	A+099	A+100	A+101	A+102	A+103	A+104	A+105	A+106	A+107	A+108	A+109	A+110	A+111
7x	A+112	A+113	A+114	A+115	A+116	A+117	A+118	A+119	A+120	A+121	A+122	A+123	A+124	A+125	A+126	A+127
8x	€	Sh↓	Sh↑	Ins	Ent (keyp)	F1	F2	F3	F4	F5	F6	F7	F8	F9	F10	F11
9x	F12	Home	End	Pg Up	Pg Dwn	↑	↓	←	→	Ar↓	Ar↑	Al↓	Al ↑	Cl ↓	Cl ↑	Cr ↓
Ax	Cr ↑	A+0161	A+0162	A+0163	A+0164	A+0165	A+0166	A+0167	A+0168	A+0169	A+0170	A+0171	A+0172	A+0173	A+0174	A+0175
Bx	A+0176	A+0177	A+0178	A+0179	A+0180	A+0181	A+0182	A+0183	A+0184	A+0185	A+0186	A+0187	A+0188	A+0189	A+0190	A+0191
Cx	A+0192	A+0193	A+0194	A+0195	A+0196	A+0197	A+0198	A+0199	A+0200	A+0201	A+0202	A+0203	A+0204	A+0205	A+0206	A+0207
Dx	A+0208	A+0209	A+0210	A+0211	A+0212	A+0213	A+0214	A+0215	A+0216	A+0217	A+0218	A+0219	A+0220	A+0221	A+0222	A+0223
Ex	A+0224	A+0225	A+0226	A+0227	A+0228	A+0229	A+0230	A+0231	A+0232	A+0233	A+0234	A+0235	A+0236	A+0237	A+0238	A+0239
Fx	A+0240	A+0241	A+0242	A+0243	A+0244	A+0245	A+0246	A+0247	A+0248	A+0249	A+0250	A+0251	A+0252	A+0253	A+0254	A+0255

Interface type USB-Keyboard Alt Mode — cont.

Table 44. Scancode Set When Control Character is 02

	x0	x1	x2	x3	x4	x5	X6	x7	x8	x9	xA	xB	xC	xD	xE	xF
0x	Ar↓	Ar↑	Al↓	Al↑	Cl↓	Cl↑	Cr↓	Cr↑	BS	Tab	→	S+ Tab	Enter Keyprd	Enter	Ins	Pg Up
1x	Pg Dwn	Home	←	↓	↑	F6	F1	F2	F3	F4	F5	ESC	F7	F8	F9	F10
2x	A+032	A+033	A+034	A+035	A+036	A+037	A+038	A+039	A+040	A+041	A+042	A+043	A+044	A+045	A+046	A+047
3x	A+048	A+049	A+050	A+051	A+052	A+053	A+054	A+055	A+056	A+057	A+058	A+059	A+060	A+061	A+062	A+063
4x	A+064	A+065	A+066	A+067	A+068	A+069	A+070	A+071	A+072	A+073	A+074	A+075	A+076	A+077	A+078	A+079
5x	A+080	A+081	A+082	A+083	A+084	A+085	A+086	A+087	A+088	A+089	A+090	A+091	A+092	A+093	A+094	A+095
6x	A+096	A+097	A+098	A+099	A+100	A+101	A+102	A+103	A+104	A+105	A+106	A+107	A+108	A+109	A+110	A+111
7x	A+112	A+113	A+114	A+115	A+116	A+117	A+118	A+119	A+120	A+121	A+122	A+123	A+124	A+125	A+126	A+127
8x	A+0128	A+0129	A+0130	A+0131	A+0132	A+0133	A+0134	A+0135	A+0136	A+0137	A+0138	A+0139	A+0140	A+0141	A+0142	A+0143
9x	A+0144	A+0145	A+0146	A+0147	A+0148	A+0149	A+0150	A+0151	A+0152	A+0153	A+0154	A+0155	A+0156	A+0157	A+0158	A+0159
Ax	A+0160	A+0161	A+0162	A+0163	A+0164	A+0165	A+0166	A+0167	A+0168	A+0169	A+0170	A+0171	A+0172	A+0173	A+0174	A+0175
Bx	A+0176	A+0177	A+0178	A+0179	A+0180	A+0181	A+0182	A+0183	A+0184	A+0185	A+0186	A+0187	A+0188	A+0189	A+0190	A+0191
Cx	A+0192	A+0193	A+0194	A+0195	A+0196	A+0197	A+0198	A+0199	A+0200	A+0201	A+0202	A+0203	A+0204	A+0205	A+0206	A+0207
Dx	A+0208	A+0209	A+0210	A+0211	A+0212	A+0213	A+0214	A+0215	A+0216	A+0217	A+0218	A+0219	A+0220	A+0221	A+0222	A+0223
Ex	A+0224	A+0225	A+0226	A+0227	A+0228	A+0229	A+0230	A+0231	A+0232	A+0233	A+0234	A+0235	A+0236	A+0237	A+0238	A+0239
Fx	A+0240	A+0241	A+0242	A+0243	A+0244	A+0245	A+0246	A+0247	A+0248	A+0249	A+0250	A+0251	A+0252	A+0253	A+0254	A+0255

Microsoft Windows Codepage 1252

Windows-1252 is a character encoding of the Latin alphabet, used by default in the legacy components of Microsoft Windows in English and some other Western languages.

	00	01	02	03	04	05	06	07	08	09	0A	0B	0C	0D	0E	0F
00	<u>MUL</u> 0000	<u>STX</u> 0001	<u>SOT</u> 0002	<u>ETX</u> 0003	<u>EOI</u> 0004	<u>ENQ</u> 0005	<u>ACK</u> 0006	<u>BEL</u> 0007	<u>BS</u> 0008	<u>HT</u> 0009	<u>LF</u> 000A	<u>VT</u> 000B	<u>FF</u> 000C	<u>CR</u> 000D	<u>SD</u> 000E	<u>SI</u> 000F
10	<u>DLE</u> 0010	<u>DC1</u> 0011	<u>DC2</u> 0012	<u>DC3</u> 0013	<u>DC4</u> 0014	<u>NAK</u> 0015	<u>SYN</u> 0016	<u>ETB</u> 0017	<u>CAN</u> 0018	<u>EM</u> 0019	<u>SUB</u> 001A	<u>ESC</u> 001B	<u>FS</u> 001C	<u>GS</u> 001D	<u>RS</u> 001E	<u>US</u> 001F
20	<u>SP</u> 0020	1 0021	" 0022	# 0023	§ 0024	% 0025	& 0026	' 0027	(0028) 0029	* 002A	+ 002B	, 002C	- 002D	. 002E	/ 002F
30	0 0030	1 0031	2 0032	3 0033	4 0034	5 0035	6 0036	7 0037	8 0038	9 0039	: 003A	; 003B	< 003C	= 003D	> 003E	? 003F
40	@ 0040	A 0041	B 0042	C 0043	D 0044	E 0045	F 0046	G 0047	H 0048	I 0049	J 004A	K 004B	L 004C	M 004D	N 004E	O 004F
50	P 0050	Q 0051	R 0052	S 0053	T 0054	U 0055	V 0056	W 0057	X 0058	Y 0059	Z 005A	[005B	\ 005C] 005D	^ 005E	_ 005F
60	` 0060	a 0061	b 0062	c 0063	d 0064	e 0065	f 0066	g 0067	h 0068	i 0069	j 006A	k 006B	l 006C	m 006D	n 006E	o 006F
70	p 0070	q 0071	r 0072	s 0073	t 0074	u 0075	v 0076	w 0077	x 0078	y 0079	z 007A	{ 007B	 007C	} 007D	~ 007E	<u>DEL</u> 007F
80	€ 20AC	• 20A2	ƒ 20A4	„ 20A6	… 20A8	† 20A9	‡ 20AA	ˆ 20AB	% 20A5	Š 20A6	< 20A7	Œ 20A8	• 20A9	Š 20AA	• 20AB	• 20AC
90	• 20A2	ˆ 20AB	˜ 20AC	˘ 20AD	• 20A9	– 20B3	— 20B4	ˆ 20AB	™ 2122	Š 20A6	› 203A	œ 20A8	• 20A9	Š 20AA	• 20AB	• 20AC
A0	<u>NBSP</u> 00A0	ı 00A1	ı 00A2	£ 00A3	¤ 00A4	¥ 00A5	ı 00A6	ı 00A7	ı 00A8	ı 00A9	ı 00AA	ı 00AB	ı 00AC	ı 00AD	ı 00AE	ı 00AF
B0	° 00B0	± 00B1	² 00B2	³ 00B3	´ 00B4	µ 00B5	¶ 00B6	· 00B7	¸ 00B8	¹ 00B9	º 00BA	» 00BB	¼ 00BC	½ 00BD	¾ 00BE	¿ 00BF
C0	À 00C0	Á 00C1	Â 00C2	Ã 00C3	Ä 00C4	Å 00C5	Æ 00C6	Ç 00C7	È 00C8	É 00C9	Ê 00CA	Ë 00CB	Ì 00CC	Í 00CD	Î 00CE	Ï 00CF
D0	Ð 00D0	Ñ 00D1	Ò 00D2	Ó 00D3	Ô 00D4	Õ 00D5	Ö 00D6	× 00D7	Ø 00D8	Ù 00D9	Ú 00DA	Û 00DB	Ü 00DC	Ý 00DD	Þ 00DE	ß 00DF
E0	à 00E0	á 00E1	â 00E2	ã 00E3	ä 00E4	å 00E5	æ 00E6	ç 00E7	è 00E8	é 00E9	ê 00EA	ë 00EB	ì 00EC	í 00ED	î 00EE	ï 00EF
F0	ø 00F0	ñ 00F1	ò 00F2	ó 00F3	ô 00F4	õ 00F5	ö 00F6	÷ 00F7	ø 00F8	ù 00F9	ú 00FA	û 00FB	ü 00FC	ý 00FD	þ 00FE	ÿ 00FF

A

Aladdin™ [9](#)

B

barcodes

cancel [277](#)
numeric barcodes [277](#)
RS-232
 baud rate [38, 59](#)
RS-232 parameters
 parity [36](#)

Beeper

 Pitch, Good Read [67](#)
Beeper, Good Read [66](#)

C

Cable Pinouts [259](#)
Clear to Send [233](#)
Conversion, case [54](#)
Conversion, character [55, 248](#)
Coupon Control [79](#)
CTS [233](#)

D

Datalogic Aladdin™ [9](#)
Defaults [263](#)

E

Error Codes [261](#)
Errors [261](#)

G

Good Read, Beeper [66](#)
 Pitch [67](#)
Good Read, Beeper – [66](#)
Good Read, Beeper Pitch – [67](#)
Green Spot [260](#)

I

Indications [260](#)
Interface Cable [12](#)
ISSN [90](#)

K

keyboard support [34](#)

P

Pitch – Good Read, Beeper [67](#)
Prefix/Suffix [42, 242](#)
Product Specifications [257](#)
Programming Barcodes [9](#)

R

Read, Beeper – Good [66](#)
Read, Beeper Pitch – Good [67](#)
Reading Configuration Barcodes [18](#)
Request to Send [233](#)
RS-232 interface selection [14](#)
RS-232 Serial Connection [12](#)
RTS [233](#)

S

sample barcodes

Index

code 128 [273](#)
code 39 [273](#)
interleaved 2 of 5 [274](#)
Scancode Tables [283](#)
select digits/characters [277](#)
Suffix [42](#), [242](#)
symbology types [273](#)

U

UPC [80](#)
USB Connection [12](#)

X

XON/XOFF [234](#)

ASCII Chart

ASCII Char.	Hex No.	ASCII Char.	Hex No.	ASCII Char.	Hex No.	ASCII Char.	Hex No.
NUL	00	SP	20	@	40	'	60
SOH	01	!	21	A	41	a	61
STX	02	"	22	B	42	b	62
ETX	03	#	23	C	43	c	63
EOT	04	\$	24	D	44	d	64
ENQ	05	%	25	E	45	e	65
ACK	06	&	26	F	46	f	66
BEL	07	'	27	G	47	g	67
BS	08	(28	H	48	h	68
HT	09)	29	I	49	i	69
LF	0A	*	2A	J	4A	j	6A
VT	0B	+	2B	K	4B	k	6B
FF	0C	,	2C	L	4C	l	6C
CR	0D	-	2D	M	4D	m	6D
SO	0E	.	2E	N	4E	n	6E
SI	0F	/	2F	O	4F	o	6F
DLE	10	0	30	P	50	p	70
DC1	11	1	31	Q	51	q	71
DC2	12	2	32	R	52	r	72
DC3	13	3	33	S	53	s	73
DC4	14	4	34	T	54	t	74
NAK	15	5	35	U	55	u	75
SYN	16	6	36	V	56	v	76
ETB	17	7	37	W	57	w	77
CAN	18	8	38	X	58	x	78
EM	19	9	39	Y	59	y	79
SUB	1A	:	3A	Z	5A	z	7A
ESC	1B	;	3B	[5B	{	7B
FS	1C	<	3C	\	5C		7C
GS	1D	=	3D]	5D	}	7D
RS	1E	>	3E	^	5E	~	7E
US	1F	?	3F	_	5F	DEL	7F

Australia

Datalogic Scanning Pty Ltd
Telephone: [61] (2) 9870 3200
australia.scanning@datalogic.com

France and Benelux

Datalogic Scanning SAS
Telephone: [33].01.64.86.71.00
france.scanning@datalogic.com

Germany

Datalogic Scanning GmbH
Telephone: 49 (0) 61 51/93 58-0
germany.scanning@datalogic.com

India

Datalogic Scanning India
Telephone: 91- 22 - 64504739
india.scanning@datalogic.com

Italy

Datalogic Scanning SpA
Telephone: [39] (0) 39/62903.1
italy.scanning@datalogic.com

Japan

Datalogic Scanning KK
Telephone: 81 (0)3 3491 6761
japan.scanning@datalogic.com

Latin America

Datalogic Scanning, Inc
Telephone: (305) 742-2206
latinamerica.scanning@datalogic.com

Singapore

Datalogic Scanning Singapore PTE LTD
Telephone: (65) 6435-1311
singapore.scanning@datalogic.com

Iberia

Datalogic Scanning SAS Sucursal en España
Telephone: 34 91 746 28 60
spain.scanning@datalogic.com

United Kingdom

Datalogic Scanning LTD
Telephone: 44 (0) 1582 464900
uk.scanning@datalogic.com



www.scanning.datalogic.com

Datalogic Scanning, Inc.

959 Terry Street
Eugene, OR 97402
USA
Telephone: (541) 683-5700
Fax: (541) 345-7140

