



LS 2208



Product Reference Guide



LS 2208
Product Reference Guide

72-58808-02
Revision A
September 2003



© 2003 by Symbol Technologies, Inc. All rights reserved.

No part of this publication may be reproduced or used in any form, or by any electrical or mechanical means, without permission in writing from Symbol. This includes electronic or mechanical means, such as photocopying, recording, or information storage and retrieval systems. The material in this guide is subject to change without notice.

The software is provided strictly on an “as is” basis. All software, including firmware, furnished to the user is on a licensed basis. Symbol grants to the user a non-transferable and non-exclusive license to use each software or firmware program delivered hereunder (licensed program). Except as noted below, such license may not be assigned, sublicensed, or otherwise transferred by the user without prior written consent of Symbol. No right to copy a licensed program in whole or in part is granted, except as permitted under copyright law. The user shall not modify, merge, or incorporate any form or portion of a licensed program with other program material, create a derivative work from a licensed program, or use a licensed program in a network without written permission from Symbol. The user agrees to maintain Symbol’s copyright notice on the licensed programs delivered hereunder, and to include the same on any authorized copies it makes, in whole or in part. The user agrees not to decompile, disassemble, decode, or reverse engineer any licensed program delivered to the user or any portion thereof.

Symbol reserves the right to make changes to any software or product to improve reliability, function, or design.

Symbol does not assume any product liability arising out of, or in connection with, the application or use of any product, circuit, or application described herein.

No license is granted, either expressly or by implication, estoppel, or otherwise under any Symbol Technologies, Inc., intellectual property rights. An implied license only exists for equipment, circuits, and subsystems contained in Symbol products.

Symbol, Spectrum One, and Spectrum24 are registered trademarks of Symbol Technologies, Inc. Other product names mentioned in this guide may be trademarks or registered trademarks of their respective companies and are hereby acknowledged.

Symbol Technologies, Inc.
One Symbol Plaza
Holtsville, New York 11742-1300
<http://www.symbol.com>

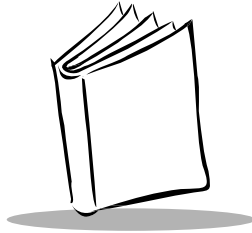

Contents

About This Guide

Introductionxi
Chapter Descriptionsxi
Notational Conventions	xiii
Related Publications	xiii
Service Information	xiii
Symbol Support Center	xiv

Chapter 1. Getting Started

Introduction	1-1
Unpacking Your Scanner	1-2
Setting Up the Scanner	1-3
Installing the Interface Cable	1-3
Connecting Power (if required)	1-4
Configuring Your Scanner	1-4
Connecting a Synapse Cable Interface	1-5
Removing the Interface Cable	1-5

Chapter 2. Scanning

Introduction	2-1
Beeper Definitions	2-2
LED Definitions	2-4
Scanning in Hand-Held Mode	2-5
Aiming	2-6
Decode Zone	2-7
Scanning in Hands-Free Mode	2-8
Assembling the Stand	2-8
Mounting the Stand (optional)	2-9
Scanning in Hands-Free Mode	2-10

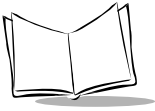

Scanning in the Hands-Free Mode 2-10

Chapter 3. Maintenance and Technical Specifications

Introduction 3-1
Maintenance 3-1
Troubleshooting 3-2
Technical Specifications 3-4
Scanner Signal Descriptions 3-6

Chapter 4. User Preferences

Introduction 4-1
Scanning Sequence Examples 4-2
Errors While Scanning 4-2
User Preferences Default Parameters 4-3
User Preferences 4-4
 Set Default Parameter 4-4
 Beeper Tone 4-5
 Beeper Volume 4-6
Power Mode 4-7
 Laser On Time 4-8
 Beep After Good Decode 4-9

Chapter 5. Keyboard Wedge Interface

Introduction 5-1
Connecting a Keyboard Wedge Interface 5-2
Keyboard Wedge Default Parameters 5-3
Keyboard Wedge Host Types 5-4
 Keyboard Wedge Host Types 5-4
 Keyboard Wedge Country Types (Country Codes) 5-5
 Ignore Unknown Characters 5-8
 Keystroke Delay 5-9
 Intra-Keystroke Delay 5-10
 Alternate Numeric Keypad Emulation 5-10
 Caps Lock On 5-11
 Caps Lock Override 5-12
 Convert Wedge Data 5-12
 Function Key Mapping 5-13
 FN1 Substitution 5-14
 Send Make and Break 5-14
 Keyboard Maps 5-15
ASCII Character Set 5-18

Chapter 6. RS-232 Interface

Introduction	6-1
Connecting an RS-232 Interface	6-2
RS-232 Default Parameters.	6-3
RS-232 Host Parameters.	6-5
RS-232 Host Types	6-7
Baud Rate.	6-9
Parity	6-11
Stop Bit Select	6-13
Data Bits.	6-13
Check Receive Errors.	6-14
Hardware Handshaking	6-15
Software Handshaking	6-17
Host Serial Response Time-out	6-20
RTS Line State	6-21
Beep on <BEL>	6-21
Intercharacter Delay	6-22
Nixdorf Beep/LED Options	6-23
Ignore Unknown Characters.	6-24
ASCII / Character Set	6-25

Chapter 7. USB Interface

Introduction	7-1
Connecting a USB Interface	7-2
USB Default Parameters	7-4
USB Host Parameters	7-5
USB Device Type	7-5
USB Country Keyboard Types (Country Codes)	7-6
USB Keystroke Delay	7-9
USB CAPS Lock Override	7-10
USB Ignore Unknown Characters.	7-11
Emulate Keypad	7-12
USB Keyboard FN 1 Substitution	7-12
Function Key Mapping	7-13
Simulated Caps Lock	7-13
Convert Case	7-14
ASCII Character Set	7-15

Chapter 8. IBM 468X/469X Interface

Introduction	8-1
Connecting to an IBM 468X/469X Host	8-2

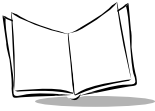

IBM Default Parameters	8-3
IBM 468X/469X Host Parameters	8-4
Port Address	8-4
Convert Unknown to Code 39	8-5

Chapter 9. Wand Emulation Interface

Introduction	9-1
Connecting Using Wand Emulation	9-2
Wand Emulation Default Parameters	9-3
Wand Emulation Host Parameters	9-4
Wand Emulation Host Types	9-4
Leading Margin (Quiet Zone)	9-5
Polarity	9-6
Ignore Unknown Characters	9-7
Convert All Bar Codes to Code 39	9-7
Convert Code 39 to Full ASCII	9-8

Chapter 10. Undecoded Scanner Emulation Interface

Introduction	10-1
Connecting Using Undecoded Scanner Emulation	10-2
Undecoded Scanner Emulation Default Parameters	10-3
Undecoded Scanner Emulation Host	10-4
Undecoded Scanner Emulation Host Parameters	10-5
Beep Style	10-5
Parameter Pass-Through	10-6
Convert Newer Code Types	10-7
Module Width	10-8
Convert All Bar Codes to Code 39	10-9
Code 39 Full ASCII Conversion	10-9
Transmission Timeout	10-10
Ignore Unknown Characters	10-11
Leading Margin	10-12
Check For Decode LED	10-13

Chapter 11. 123Scan

Introduction	11-1
Communication With the 123Scan PC Based Configuration Tool	11-1
123Scan Parameter	11-2

Chapter 12. Symbologies

Introduction	12-1
Scanning Sequence Examples	12-1
Errors While Scanning	12-2
Symbology Default Parameters	12-3
UPC/EAN	12-7
Enable/Disable UPC-A/UPC-E	12-7
Enable/Disable UPC-E1	12-8
Enable/Disable EAN-13/EAN-8	12-9
Enable/Disable Bookland EAN	12-10
Decode UPC/EAN/JAN Supplementals	12-11
UPC/EAN/JAN Supplemental Redundancy	12-13
Transmit UPC-A/UPC-E/UPC-E1 Check Digit	12-14
UPC-A Preamble	12-16
UPC-E Preamble	12-17
UPC-E1 Preamble	12-18
Convert UPC-E to UPC-A	12-19
Convert UPC-E1 to UPC-A	12-20
EAN-8/JAN-8 Extend	12-21
UPC/EAN Security Level	12-22
UCC Coupon Extended Code	12-24
Code 128	12-25
Enable/Disable Code 128	12-25
Enable/Disable UCC/EAN-128	12-26
Code 39	12-27
Enable/Disable Code 39	12-27
Enable/Disable Trioptic Code 39	12-28
Convert Code 39 to Code 32	12-29
Code 32 Prefix	12-30
Set Lengths for Code 39	12-31
Code 39 Check Digit Verification	12-33
Transmit Code 39 Check Digit	12-34
Code 39 Full ASCII Conversion	12-35
Code 39 Buffering (Scan & Store)	12-36
Code 93	12-40
Enable/Disable Code 93	12-40
Set Lengths for Code 93	12-41
Code 11	12-43
Code 11	12-43
Set Lengths for Code 11	12-44
Code 11 Check Digit Verification	12-46
Transmit Code 11 Check Digits	12-47
Interleaved 2 of 5 (ITF)	12-48

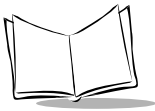

Enable/Disable Interleaved 2 of 5	12-48
Set Lengths for Interleaved 2 of 5	12-49
I 2 of 5 Check Digit Verification	12-51
Transmit I 2 of 5 Check Digit	12-52
Convert I 2 of 5 to EAN-13.	12-53
Discrete 2 of 5 (DTF).	12-54
Enable/Disable Discrete 2 of 5.	12-54
Set Lengths for Discrete 2 of 5	12-55
Chinese 2 of 5.	12-57
Enable/Disable Chinese 2 of 5.	12-57
Codabar (NW - 7)	12-58
Enable/Disable Codabar	12-58
Set Lengths for Codabar	12-59
CLSI Editing	12-61
NOTIS Editing	12-62
MSI	12-63
Enable/Disable MSI	12-63
Set Lengths for MSI	12-64
MSI Check Digits	12-66
Transmit MSI Check Digit(s)	12-67
MSI Check Digit Algorithm	12-68
RSS (Reduced Space Symbology)	12-69
RSS	12-69
Convert RSS to UPC/EAN.	12-71
Redundancy Level	12-72
Redundancy Level 1	12-72
Redundancy Level 2	12-73
Redundancy Level 4	12-74
Security Level	12-75
Bi-directional Redundancy.	12-77
Intercharacter Gap Size.	12-78

Chapter 13. Miscellaneous Scanner Options

Introduction	13-1
Scanning Sequence Examples	13-2
Errors While Scanning	13-2
Miscellaneous Default Parameters	13-3
Miscellaneous Scanner Parameters	13-4
Transmit Code ID Character	13-4
Prefix/Suffix Values	13-5
Scan Data Transmission Format	13-6
FN1 Substitution Values	13-9
Transmit "No Read" Message	13-10

Synapse Interface 13-11

Chapter 14. Advanced Data Formatting

Introduction 14-1

Rules: Criteria Linked to Actions 14-1

Using ADF Bar Codes 14-2

ADF Bar Code Menu Example. 14-3

 Rule 1: The Code 128 Scanning Rule 14-4

 Rule 2: The UPC Scanning Rule 14-4

 Alternate Rule Sets. 14-4

 Rules Hierarchy (in Bar Codes) 14-6

 Default Rules 14-7

Special Commands 14-8

 Pause Duration. 14-8

 Begin New Rule 14-8

 Save Rule 14-9

 Erase 14-9

 Quit Entering Rules 14-10

 Disable Rule Set. 14-11

Criteria 14-12

 Code Types 14-12

 Code Lengths 14-15

 Message Containing A Specific Data String 14-20

Actions 14-24

 Send Data 14-24

 Setup Field(s) 14-28

 Modify Data 14-34

 Pad Data with Spaces 14-37

 Pad Data with Zeros 14-41

 Beeps 14-45

 Send Keystroke (Control Characters and Keyboard Characters). 14-46

 Send Right Control Key 14-76

 Send Graphic User Interface (GUI) Characters 14-76

 Turn On/Off Rule Sets 14-83

Alphanumeric Keyboard. 14-84

Appendix A. Standard Default Parameters

Appendix B. Programming Reference

Symbol Code Identifiers. B-1

AIM Code Identifiers B-3

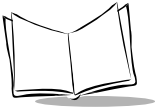

Appendix C. Sample Bar Codes

Code 39C-1
UPC/EANC-1
UPC-A, 100 %C-1
EAN-13, 100 %C-2
Code 128C-2
Interleaved 2 of 5C-2
RSS 14C-3

Appendix D. Numeric Bar Codes

0, 1D-1
2, 3, 4D-2
5, 6, 7D-3
8, 9D-4
CancelD-5

Glossary

Index

Feedback

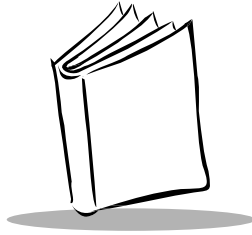

About This Guide

Introduction

The *LS 2208 Product Reference Guide* provides general instructions for setting up, operating, maintaining and troubleshooting the LS 2208.

Chapter Descriptions

- Chapter 1, *Getting Started* provides a product overview and unpacking instructions.
- Chapter 2, *Scanning* describes parts of the scanner, beeper and LED definitions, how to use the scanner in hand-held and hands-free modes.
- Chapter 3, *Maintenance and Technical Specifications* provides information on how to care for your scanner, troubleshooting, and technical specifications.
- Chapter 4, *User Preferences* provides the programming bar codes necessary for selecting user preference features for your scanner.
- Chapter 5, *Keyboard Wedge Interface* covers information for setting up your scanner for Keyboard Wedge operation.
- Chapter 6, *RS-232 Interface* covers information for setting up your scanner for RS-232 operation.
- Chapter 7, *USB Interface* covers information for setting up your scanner for USB operation.
- Chapter 8, *IBM 468X/469X Interface* covers all information for setting up your scanner with IBM 468X/469X POS systems.

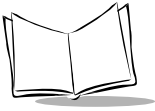

- Chapter 9, *Wand Emulation Interface* covers all information for setting up your scanner for Wand emulation operation.
- Chapter 10, *Undecoded Scanner Emulation Interface* covers information for setting up your scanner for Undecoded Scanner emulation operation.
- Chapter 11, *123Scan* (PC based scanner configuration tool) provides the bar code you must scan to communicate with the 123Scan program.
- Chapter 12, *Symbologies* describes all symbology features and provides the programming bar codes necessary for selecting these features for your scanner.
- Chapter 13, *Miscellaneous Scanner Options* includes commonly used bar codes to customize how your data is transmitted to your host device.
- Chapter 14, *Advanced Data Formatting (ADF)* describes how to customize scanned data before transmitting to the host.
- Appendix A, *Standard Default Parameters* provides a table of all host devices and miscellaneous scanner defaults.
- Appendix B, *Programming Reference* provides a table of AIM code identifiers, ASCII character conversions, and keyboard maps.
- Appendix C, *Sample Bar Codes* includes sample bar codes.
- Appendix D, *Numeric Bar Codes* includes the numeric bar codes to scan for parameters requiring specific numeric values.

Notational Conventions

The following conventions are used in this document:

- Bullets (•) indicate:
 - action items
 - lists of alternatives
 - lists of required steps that are not necessarily sequential
- Sequential lists (e.g., those that describe step-by-step procedures) appear as numbered lists.
- Throughout the programming bar code menus, asterisks (*) are used to denote default parameter settings.



* Indicates Default — **Baud Rate 9600** — Feature/Option

Related Publications

The *LS 2208 Series Quick Reference Guide*, p/n 72-58807-xx, provides general information to help the user get started with the scanner. It includes basic set-up and operation instructions.

For the latest versions of the *LS 2208 Series Quick Reference Guide* and *Product Reference Guide* go to: <http://www.symbol.com/manuals>.

Service Information

If you have a problem with your equipment, contact the *Symbol Support Center* for your region. See page xiv for contact information. Before calling, have the model number, serial number, and several of your bar code symbols at hand.

Call the Support Center from a phone near the scanning equipment so that the service person can try to talk you through your problem. If the equipment is found to be working properly and the problem is reading bar codes, the Support Center will request samples of your bar codes for analysis at our plant.

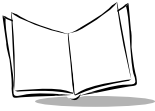

If your problem cannot be solved over the phone, you may need to return your equipment for servicing. If that is necessary, you will be given specific directions.

Note: *Symbol Technologies is not responsible for any damages incurred during shipment if the approved shipping container is not used. Shipping the units improperly can possibly void the warranty. If the original shipping container was not kept, contact Symbol to have another sent to you.*

Symbol Support Center

For service information, warranty information or technical assistance contact or call the Symbol Support Center in:

United States

Symbol Technologies, Inc.
One Symbol Plaza
Holtsville, New York 11742-1300
1-800-653-5350

United Kingdom

Symbol Technologies
Symbol Place
Winnersh Triangle, Berkshire RG41 5TP
United Kingdom
0800 328 2424 (Inside UK)
+44 118 945 7529 (Outside UK)

Australia

Symbol Technologies Pty. Ltd.
432 St. Kilda Road
Melbourne, Victoria 3004
1-800-672-906 (Inside Australia)
+61-3-9866-6044 (Outside Australia)

Canada

Symbol Technologies Canada, Inc.
2540 Matheson Boulevard East
Mississauga, Ontario, Canada L4W 4Z2
905-629-7226

Asia/Pacific

Symbol Technologies Asia, Inc (Singapore Branch)
230 Victoria Street #05-07/09
Bugis Junction Office Tower
Singapore 188024
Tel : +65-6796-9600
Fax : +65-6337-6488

Austria/Österreich

Symbol Technologies Austria GmbH
Prinz-Eugen Strasse 70 / 2.Haus
1040 Vienna, Austria
01-5055794-0 (Inside Austria)
+43-1-5055794-0 (Outside Austria)

Denmark/Danmark

Symbol Technologies AS
Dr. Neergaardsvej 3
2970 Hørsholm
7020-1718 (Inside Denmark)
+45-7020-1718 (Outside Denmark)

Finland/Suomi

Oy Symbol Technologies
Kaupintie 8 A 6
FIN-00440 Helsinki, Finland
9 5407 580 (Inside Finland)
+358 9 5407 580 (Outside Finland)

Germany/Deutschland

Symbol Technologies GmbH
Waldstrasse 66
D-63128 Dietzenbach, Germany
6074-49020 (Inside Germany)
+49-6074-49020 (Outside Germany)

Latin America Sales Support

2730 University Dr.
Coral Springs, FL 33065
954-255-2610 PH
954-340-9454 Fax
1-800-347-0178 (Inside United States)
+1-954-255-2610 (Outside United States)

Europe/Mid-East Distributor Operations

Contact your local distributor or call
+44 118 945 7360

France

Symbol Technologies France
Centre d'Affaire d'Antony
3 Rue de la Renaissance
92184 Antony Cedex, France
01-40-96-52-21 (Inside France)
+33-1-40-96-52-50 (Outside France)

Italy/Italia

Symbol Technologies Italia S.R.L.
Via Cristoforo Colombo, 49
20090 Trezzano S/N Naviglio
Milano, Italy
2-484441 (Inside Italy)
+39-02-484441 (Outside Italy)

Mexico/México

Symbol Technologies Mexico Ltd.
Torre Picasso
Boulevard Manuel Avila Camacho No 88
Lomas de Chapultepec CP 11000
Mexico City, DF, Mexico
5-520-1835 (Inside Mexico)
+52-5-520-1835 (Outside Mexico)

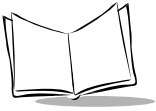

Netherlands/Nederland

Symbol Technologies
Kerkplein 2, 7051 CX
Postbus 24 7050 AA
Varsseveld, Netherlands
315-271700 (Inside Netherlands)
+31-315-271700 (Outside Netherlands)

South Africa

Symbol Technologies Africa Inc.
Block B2
Rutherford Estate
1 Scott Street
Waverly 2090 Johannesburg
Republic of South Africa
11-809 5311 (Inside South Africa)
+27-11-809 5311 (Outside South Africa)

Norway/Norge

Symbol's registered and mailing address:
Symbol Technologies Norway
Hoybratenveien 35 C
N-1055 OSLO, Norway

Symbol's repair depot and shipping address:
Symbol Technologies Norway
Enebakkeveien 123
N-0680 OSLO, Norway

+47 2232 4375

Spain/España

Symbol Technologies S.L.
C/ Peonias, 2
Edificio Piovera Azul
28042 Madrid, Spain
91 324 40 00 (Inside Spain)
+34 91 324 40 00 (Outside Spain)

Sweden/Sverige

“Letter” address:

Symbol Technologies AB

Box 1354

S-171 26 SOLNA

Sweden

Visit/shipping address:

Symbol Technologies AB

Solna Strandväg 78

S-171 54 SOLNA

Sweden

Switchboard: 08 445 29 00 (domestic)

Call Center: +46 8 445 29 29 (international)

Support E-Mail:

Sweden.Support@se.symbol.com

If you purchased your Symbol product from a Symbol Business Partner, contact that Business Partner for service.

For the latest version of this guide go to:<http://www.symbol.com/manuals>.

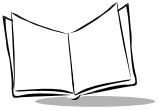

LS 2208 Product Reference Guide

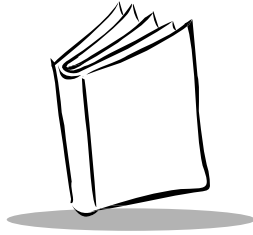

Chapter 1

Getting Started

Introduction

The LS 2208 scanner combines excellent scanning performance and advanced ergonomics to provide the best value in a lightweight laser scanner. Whether used as a hand-held scanner or in hands-free mode in a stand, the scanner ensures comfort and ease of use for extended periods of time.

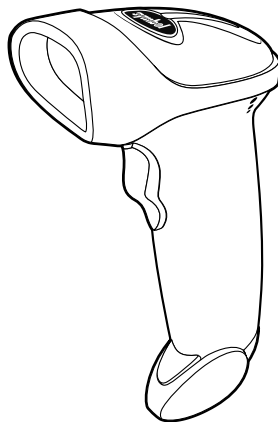
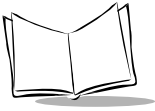

Figure 1-1. LS 2208 Scanner

- This LS 2208 scanner supports the following interfaces:
 - Standard RS-232 connection to a host. Proper communications of the scanner with the host is set up by scanning bar code menus.



- Keyboard Wedge connection to a host. Scanned data is interpreted by your host as keystrokes.
 - International Keyboards supported: North America, German, French, French International, Spanish, Italian, Swedish, British, Japanese, and Portuguese-Brazilian.
- Wand Emulation connection to a host. The scanner is connected to a portable data terminal, a controller, or host which collects the data as wand data and decodes it.
- Undecoded Emulation connection to a host. The scanner is connected to a portable data terminal, a controller which collects the data and interprets it for the host.
- Connection to IBM 468X/469X hosts. Proper communications of the scanner with the IBM terminal is set up by scanning bar codes.
- USB connection to a host. The scanner autodetects a USB host and defaults to the HID keyboard interface type. Other USB interface types are selectable by scanning programming bar code menus.
 - International Keyboards supported (for Windows™ environment): North America, German, French, French International, Spanish, Italian, Swedish, British, Portuguese-Brazilian, and Japanese.
- Synapse capability which allows you to connect to a wide variety of host systems using a Synapse and Synapse adapter cable to connect to a host. The scanner autodetects a Synapse.
- Configuration via 123Scan.

Unpacking Your Scanner

Remove the scanner from its packing and inspect it for damage. If the scanner was damaged in transit, call the *Symbol Support Center* at one of the telephone numbers listed on page xiv. **KEEP THE PACKING.** It is the approved shipping container and should be used if you ever need to return your equipment for servicing.

Setting Up the Scanner

Installing the Interface Cable

1. Plug the interface cable modular connector into the cable interface port on the bottom of the scanner handle. (See Figure 1-2.)
2. Gently tug the cable to ensure the connector is properly secured.
3. Connect the other end of the interface cable to the host (see the specific host chapter for information on host connections).

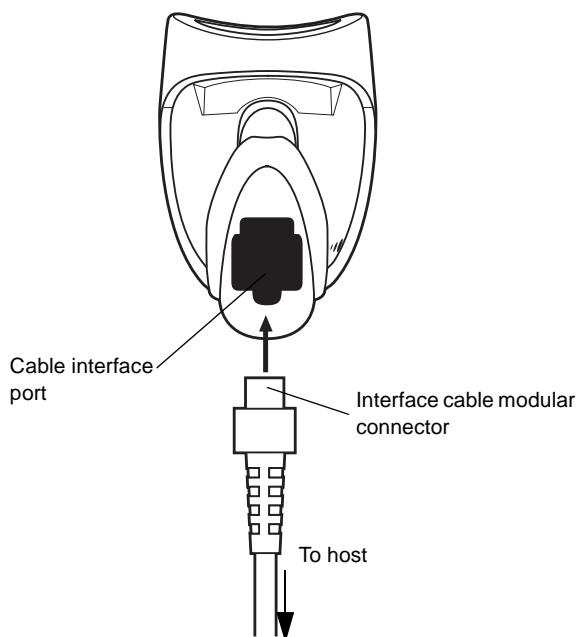
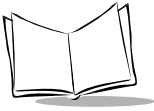

Figure 1-2. Installing the Cable

Note: *Different cables are required for different hosts. The connectors illustrated in each host chapter are examples only. Your connectors may be different than those illustrated, but the steps to connect your scanner remain the same.*



Connecting Power (if required)

If your host does not provide power to the scanner, you will need an external power connection to the scanner:

1. Connect the interface cable to the bottom of the scanner, as described in *Installing the Interface Cable* on page 1-3.
2. Connect the other end of the interface cable to the host (refer to your host manual to locate the correct port).
3. Plug the power supply into the power jack on the interface cable. Plug the other end of the power supply into an AC outlet.

Configuring Your Scanner

Two methods are available to configure your scanner: using the bar codes included in this manual, or the 123Scan configuration program.

Refer to Chapter 4, *User Preferences* for information about programming your scanner using bar code menus. Refer to Chapter 11, *123Scan* to configure your scanner using this configuration program. A helpfile is available in the program.

The scanner supports RS-232, IBM 468X/469X, Keyboard Wedge, Wand Emulation, Undecoded Scanner Emulation, USB, and Synapse to interface to a host system. Each host specific chapter describes how to set up each of these connections.

Connecting a Synapse Cable Interface

Note: See the *Synapse Interface Guide* provided with your Synapse cable for detailed setup instructions.

Symbol's Synapse Smart Cables enable interfacing to a variety of hosts. The appropriate Synapse cable has the built-in intelligence to detect the host to which it is connected.

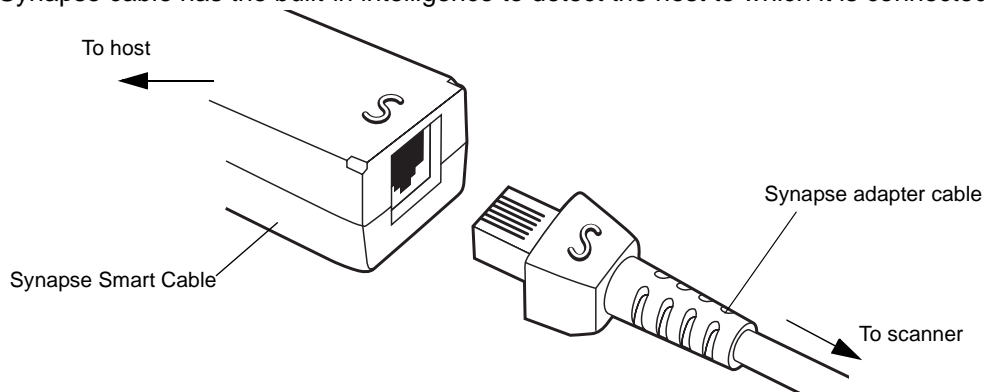

Figure 1-3. Synapse Cable Connection

1. Plug the Synapse adapter cable (p/n 25-32463-xx) into the bottom of the scanner, as described in *Installing the Interface Cable* on page 1-3.
2. Align the 'S' on the Synapse adapter cable with the 'S' on the Synapse Smart Cable and plug the cable in.
3. Connect the other end of the Synapse Smart Cable to the host.

Removing the Interface Cable

To remove the interface cable:

1. Unplug the installed cable's modular connector by depressing the connector clip with the tip of a screwdriver.
2. Carefully slide out the cable.
3. Follow the steps for *Installing the Interface Cable* on page 1-3 to connect a new cable.

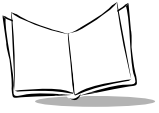

LS 2208 Product Reference Guide

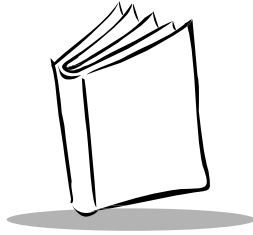

Chapter 2 Scanning

Introduction

This chapter covers the techniques involved in scanning bar codes, beeper and LED definitions, and general instructions and tips about scanning.

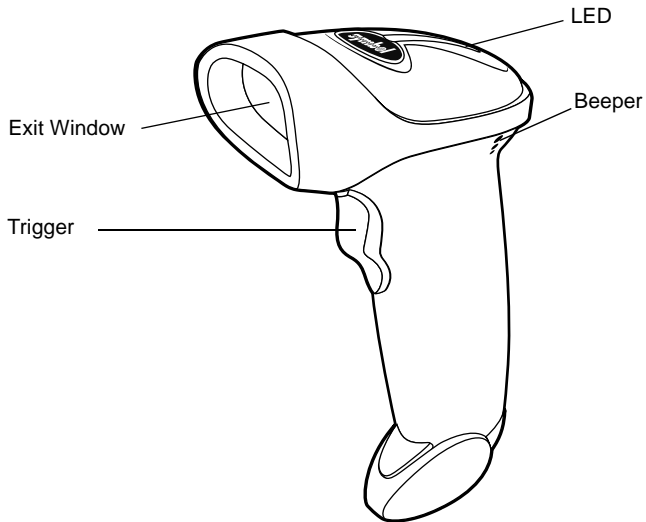
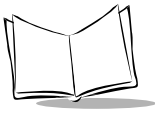

Figure 2-1. Scanner Parts



Beeper Definitions

The scanner communicates with the user by emitting different beeper sequences and patterns. Table 2-1 defines beep sequences that occur during both normal scanning and while programming the scanner.

Table 2-1. Standard Beeper Definitions

Beeper Sequence	Indication
Standard Use	
Low/medium/high beep	Power up.
Short high beep	A bar code symbol was decoded (if decode beeper is enabled).
4 long low beeps	A transmission error was detected in a scanned symbol. The data is ignored. This occurs if a unit is not properly configured. Check option setting.
5 low beeps	Conversion or format error.
Lo/hi/lo beep	ADF transmit error.
Hi/hi/hi/lo beep	RS-232 receive error.
Parameter Menu Scanning	
Short high beep	Correct entry scanned or correct menu sequence performed.
Lo/hi beep	Input error, incorrect bar code or "Cancel" scanned, wrong entry, incorrect bar code programming sequence; remain in program mode.
Hi/lo beep	Keyboard parameter selected. Enter value using bar code keypad.
Hi/lo/hi/lo beep	Successful program exit with change in the parameter setting.
Low/hi/low/hi beep	Out of host parameter storage space. Scan <i>Set Default Parameter</i> on page 4-4.
Code 39 Buffering	
Hi/lo beep	New Code 39 data was entered into the buffer.
3 Beeps - long high beep	Code 39 buffer is full.

Table 2-1. Standard Beeper Definitions (Continued)

Beeper Sequence	Indication
Lo/hi/lo beep	The Code 39 buffer was erased or there was an attempt to clear or transmit an empty buffer.
Lo/hi beep	A successful transmission of buffered data.
Host Specific	
USB only	
4 short high beeps	Scanner has not completed initialization. Wait several seconds and scan again.
Scanner gives a power-up beep after scanning a USB Device Type.	Communication with the bus must be established before the scanner can operate at the highest power level.
This power-up beep occurs more than once.	The USB bus may put the scanner in a state where power to the scanner is cycled on and off more than once. This is normal and usually happens when the PC cold boots.
RS-232 only	
1 short high beep	A <BEL> character is received and Beep on <BEL> is enabled.

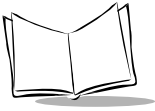

LED Definitions

In addition to beeper sequences, the scanner communicates with the user using a two-color LED display. Table 2-2 defines LED colors that display during scanning.

Table 2-2. Standard LED Definitions

LED	Indication
Off	No power is applied to the scanner, or the scanner is on and ready to scan.
Green	A bar code was successfully decoded.
Red	A data transmission error or scanner malfunction occurred.

Scanning in Hand-Held Mode

Install and program your scanner. (Refer to each host chapter and Chapter 4, *User Preferences*, Chapter 12, *Symbologies*, Chapter 13, *Miscellaneous Scanner Options*, and Chapter 14, *Advanced Data Formatting* for instructions on programming your scanner.) If you need assistance, contact your local supplier or your local *Symbol Support Center*.

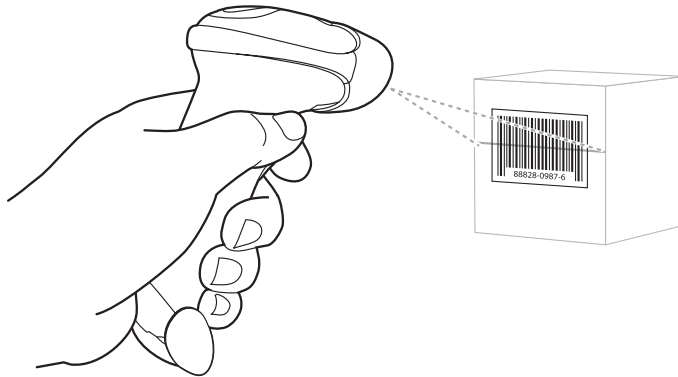
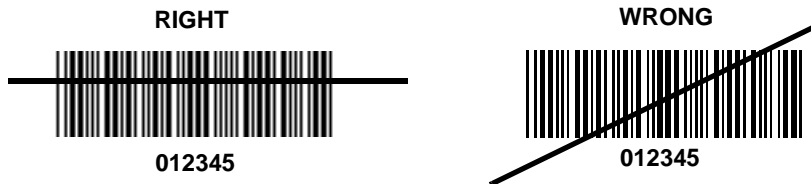
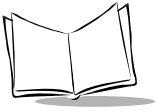

Figure 2-2. Scanning in Hand-Held Mode

1. Ensure all connections are secure. (Refer to the host chapter for your scanner.)
2. Aim the scanner at the bar code. Press the trigger.
3. Ensure the scan line crosses every bar and space of the symbol.



4. Upon successful decode, the scanner beeps and the LED turns green. (For more information on beeper and LED definitions, refer to Table 2-1 and Table 2-2.)



Aiming

Do not hold the scanner directly over the bar code. Laser light reflecting *directly* back into the scanner from the bar code is known as specular reflection. This specular reflection can make decoding difficult.

You can tilt the scanner up to 55° forward or back and achieve a successful decode (Figure 2-3). Simple practice quickly shows what tolerances to work within.

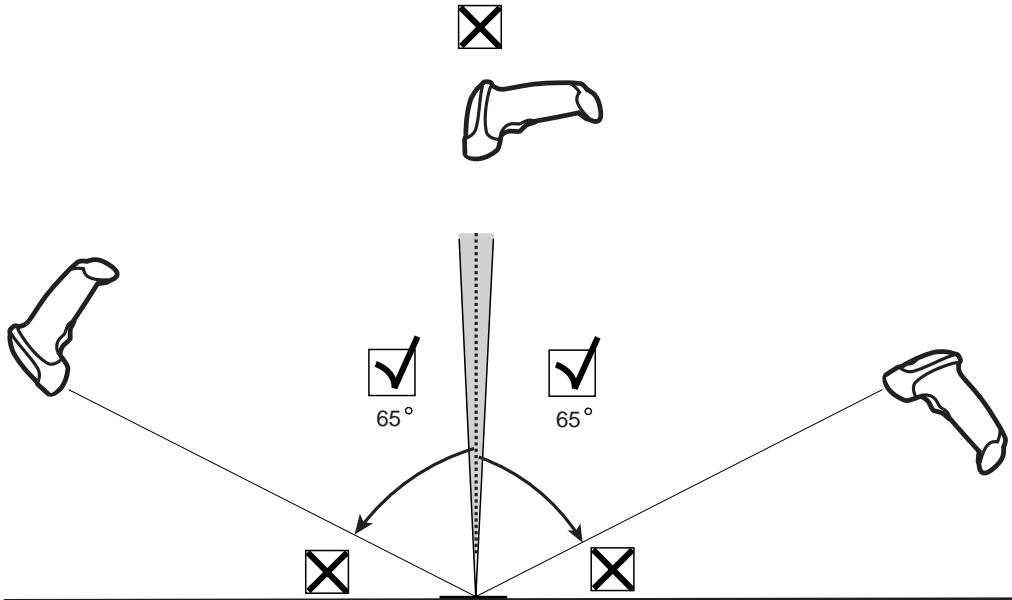
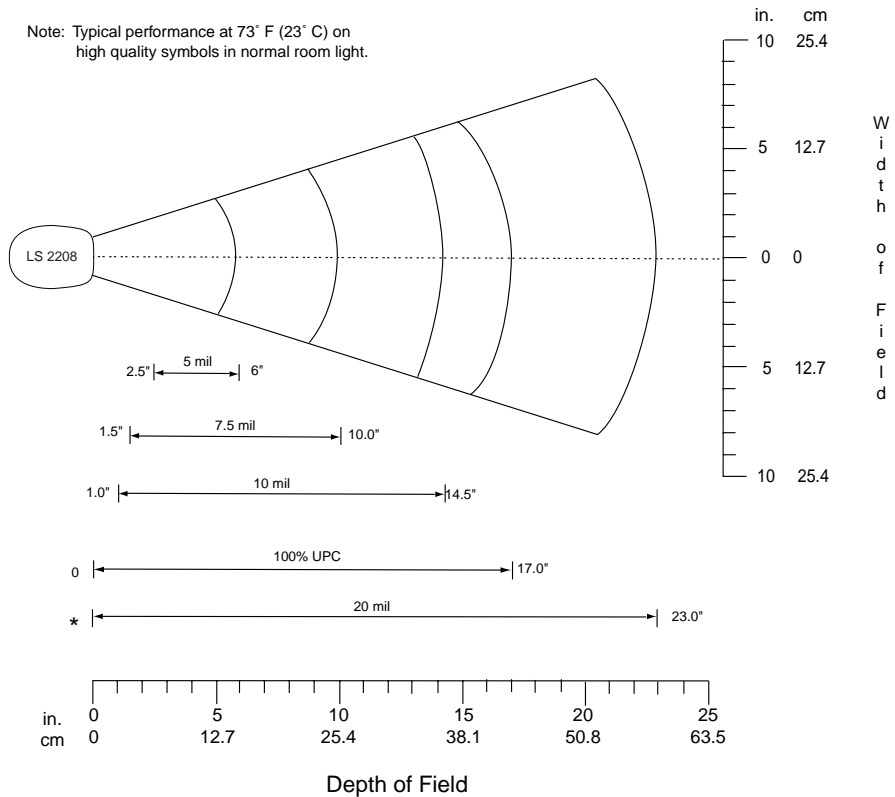

Figure 2-3. Maximum Tilt Angles and Dead Zone

Decode Zone

Note: Typical performance at 73° F (23° C) on high quality symbols in normal room light.



*Minimum distance determined by symbol length and scan angle

Figure 2-4. LS 2208 Decode Zone

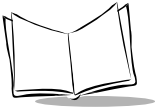

Scanning in Hands-Free Mode

The LS 2208 Intellistand adds greater flexibility to your scanning operation. Refer to *Assembling the Stand*, *Mounting the Stand (optional)*, and *Scanning in the Hands-Free Mode* for detailed information about hands-free scanning.

Assembling the Stand

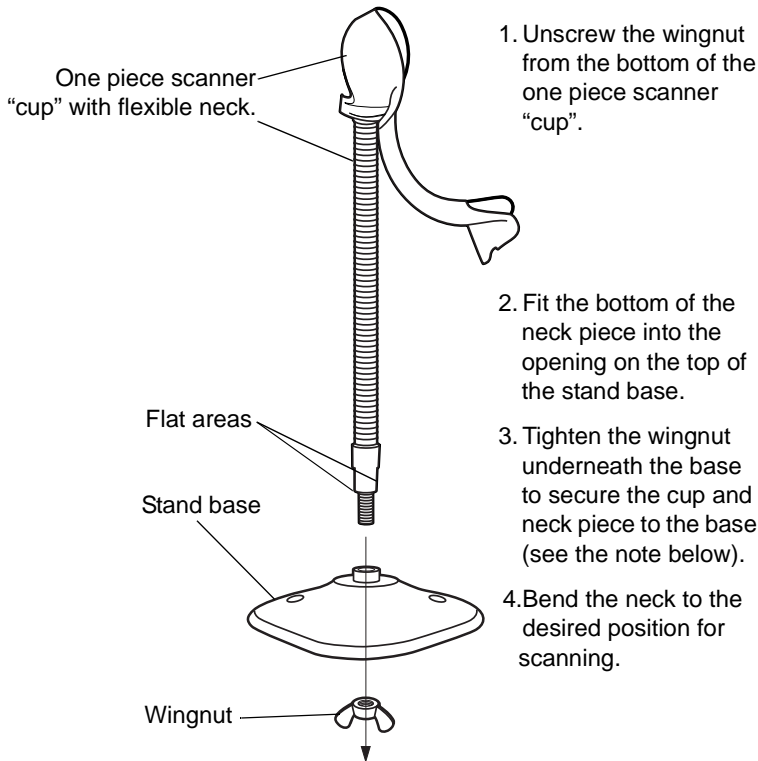

Figure 2-5. Assembling the Stand

Note: Before tightening the wingnut under the base, ensure that the flat areas on the flexible neck fit securely in the grooves in the base.

Mounting the Stand (optional)

You can attach the base of the scanner's stand to a flat surface using two screws or double-sided tape (not provided).

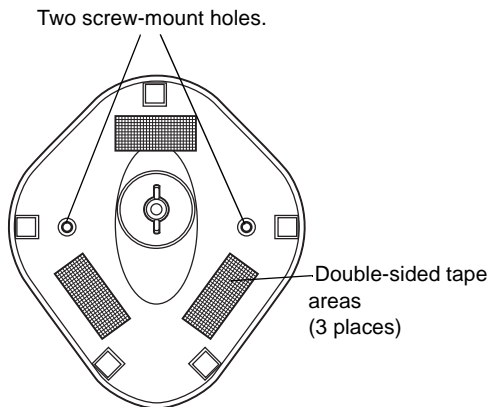

Figure 2-6. Mounting the Stand

Screw Mount

1. Position the assembled base on a flat surface.
2. Screw one #10 wood screw into each screw-mount hole until the base of the stand is secure (see Figure 2-6).

Tape Mount

1. Peel the paper liner off one side of each piece of tape and place the sticky surface over each of the three rectangular tape holders.
2. Peel the paper liner off the exposed sides of each piece of tape and press the stand on a flat surface until it is secure (see Figure 2-6).

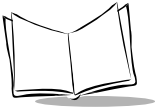

Scanning in Hands-Free Mode

The optional Intellistand adds greater flexibility to your scanning operation.

Scanning in the Hands-Free Mode

When the scanner is seated in the stand's "cup", the scanner's built-in sensor places the scanner in hands-free mode. When the scanner is removed from the stand it operates in its normal hand-held mode.

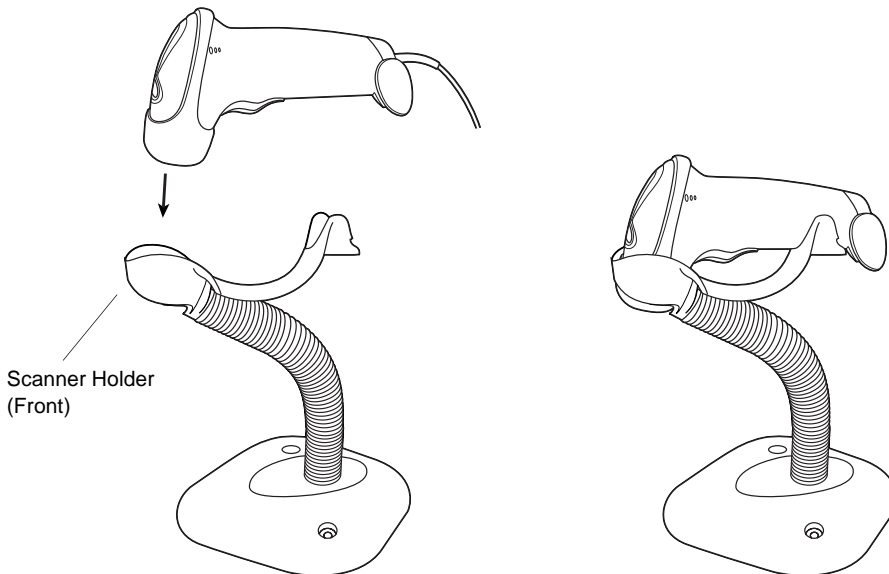
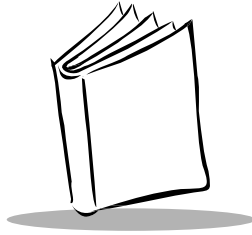

Figure 2-7. Inserting and Using the Scanner in the Stand

Intellistand operation:

1. Ensure all cable connections are secure.
2. Insert the scanner in the optional Intellistand by placing the front of the scanner into the stand's "cup" (see Figure 2-7).
3. To scan a bar code, present the bar code and ensure the scan line crosses every bar and space of the symbol.
4. Upon successful decode, the scanner beeps and the LED turns green.



Chapter 3

Maintenance and Technical Specifications

Introduction

This chapter covers suggested scanner maintenance, troubleshooting, technical specifications, and signal descriptions (pinouts).

Maintenance

Cleaning the exit window is the only maintenance required. A dirty window may affect scanning accuracy.

- Do not allow any abrasive material to touch the window
- Remove any dirt particles with a damp cloth
- Wipe the window using a tissue moistened with ammonia/water
- Do not spray water or other cleaning liquids directly into the window.

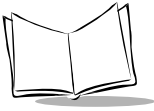

Troubleshooting

Table 3-1. Troubleshooting

Problem	Possible Causes	Possible Solutions
Nothing happens when you follow the operating instructions, or the scanner displays erratic behavior (laser does not come on, scanner emits frequent beeps).	No power to the scanner.	Check the system power. Ensure the power supply is connected if your configuration requires a power supply.
	Interface/power cables are loose.	Check for loose cable connections.
Laser comes on, but symbol does not decode.	Scanner is not programmed for the correct bar code type.	Be sure the scanner is programmed to read the type of bar code you are scanning.
	Bar code symbol is unreadable.	Check the symbol to make sure it is not defaced. Try scanning test symbols of the same bar code type.
	Distance between scanner and bar code is incorrect.	Move the scanner closer to or further from the bar code.
Symbol is decoded, but not transmitted to the host.	Scanner is not programmed for the correct host type.	Scan the appropriate host type bar code.

Table 3-1. Troubleshooting (Continued)

Problem	Possible Causes	Possible Solutions
<p>Scanned data is incorrectly displayed on the host.</p>	<p>Scanner is not programmed to work with the host. Check scanner host type parameters or editing options.</p>	<p>Be sure proper host is selected. (See the host chapter for your scanner.)</p> <p>For RS-232, ensure the scanner's communication parameters match the host's settings.</p> <p>For a USB HID keyboard or a keyboard wedge configuration, ensure the system is programmed for the correct keyboard type and language, and the CAPS LOCK key is in the correct state.</p> <p>Be sure editing options (e.g., ADF, UPC-E to UPC-A Conversion) are properly programmed.</p>

Note: If after performing these checks the symbol still does not scan, contact your distributor or call the local Symbol Support Center. See page xiv for the telephone numbers.

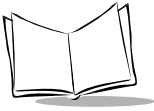

Technical Specifications

Table 3-2. Technical Specifications

Item	Description
Power Requirements	Decoded: 5 VDC + / - 10% @ approximately 200mA (nominal)
Stand-By Current	500mA (max)
Power Source	Depending on host: <ul style="list-style-type: none">• Host powered• External power supply• Battery box: Converts a 9 Volt battery to a 5 Volt battery
Decode Capability	Decoded: UPC/EAN, UPC/EAN with supplementals, UCC/EAN, JAN 8 & 13, 128, Code 39, Code 39 Full ASCII, Code 39 Trioptic, Codabar (NW7), Interleaved 2 of 5, Discrete 2 of 5, Code 128, Code 93, MSI, Code 11, UCC/EAN RSS, Code 32, Coupon Code, Bookland EAN, 1ATA, and RSS.
Beeper Operation	User-selectable: Enable, Disable
Beeper Volume	User-selectable: three levels
Beeper Tone	User-selectable: three tones
Scan Repetition Rate	100 ± 5 scans/second
Yaw Tolerance	± 10° from nominal
Pitch Tolerance	± 65° from nominal
Roll Tolerance	± 60° from nominal
Print Contrast Minimum	25% minimum reflectance differential, measured at 650 nm.
Ambient Light Immunity	Indoor: 450 Ft Candles (4,842 Lux) (indoor) Outdoor: 10,000 Ft Candles (107,600 Lux) (outdoor)
Durability	5 ft (1.5 m) drops to concrete
Operating Temperature	32° to 120° F (0° to 50° C)

Table 3-2. Technical Specifications (Continued)

Item	Description
Storage Temperature	-40° to 140° F (-40° to 60° C)
Humidity	5% to 95% (non-condensing)
Weight (without cable)	5.15 oz. (146 g)
Dimensions: Height Width Depth	6.0 in. (15.2 cm) 2.5in. (6.3 cm) 3.34 in. (8.4 cm)
Laser	650nm laser diode
Laser Classifications	IEC 825-1 Class 2
ESD	15 kV area discharge 8 kV contact discharge
Minimum Element Width	5 mil (0.127 mm)
Interfaces Supported	Decoded: RS-232, Keyboard Wedge, Wand Emulation, Undecoded Scanner Emulation, IBM 468X/469X, USB, Synapse
Electrical Safety	Certified Pending to UL1950, CSA C22.2 No.950. EN60950/IC950
Input Transient Protection	IEC 1000-4-(2,3,4,5,6,11)
EMI	FCC Part 15 Class B, ICES-003 Class B European Union EMC Directive, Australian SMA, Taiwan EMC, Japan VCCI/MITI/Dentori

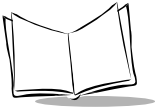

Scanner Signal Descriptions

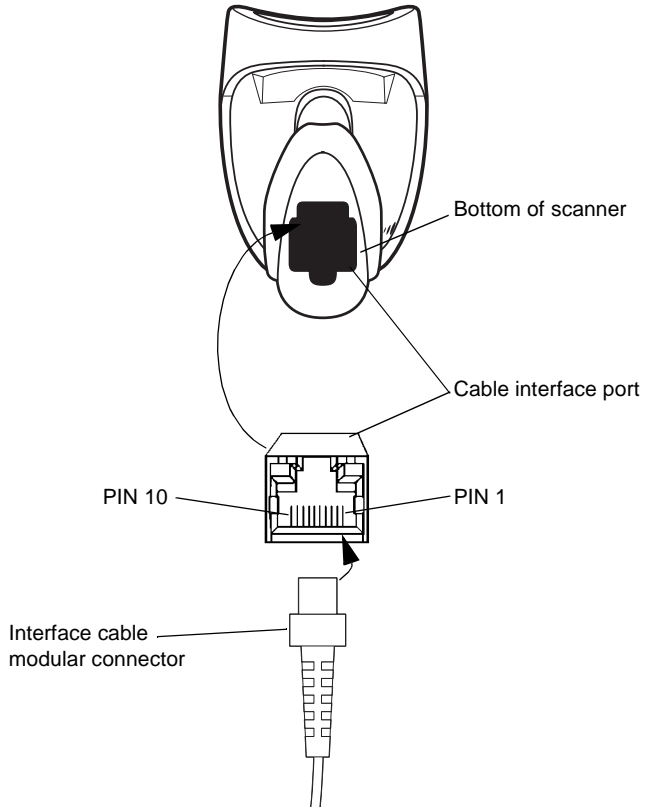
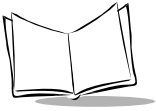

Figure 3-1. Scanner Cable Pinouts

The signal descriptions in Table 3-3 apply to the connector on the scanner and are for reference only.

Table 3-3. Scanner Signal Pin-outs

Pin	LS2208					
	IBM	Synapse	RS-232	Keyboard Wedge	Wand	USB
1	Reserved	SynClock	Reserved	Reserved	Reserved	Jump to Pin 6
2	Power	Power	Power	Power	Power	Power
3	Ground	Ground	Ground	Ground	Ground	Ground
4	IBM_A(+)	Reserved	TxD	KeyClock	DBP	Reserved
5	Reserved	Reserved	RxD	TermData	CTS	D +
6	IBM_B(-)	SynData	RTS	KeyData	RTS	Jump to Pin 1
7	Reserved	Reserved	CTS	TermClock	Reserved	D -
8	Reserved	Reserved	Reserved	Reserved	Reserved	Reserved
9	Reserved	Reserved	Reserved	Reserved	Reserved	Reserved
10	Reserved	Reserved	Reserved	Reserved	Reserved	Reserved



LS 2208 Product Reference Guide

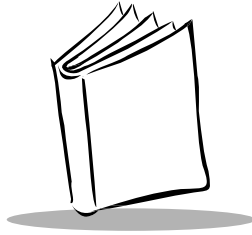

Chapter 4

User Preferences

Introduction

You have the option to program the LS 2208 scanner to perform various functions, or activate different features. This chapter describes each user preference feature and provides the programming bar codes necessary for selecting these features for your LS 2208 scanner.

Your LS 2208 is shipped with the settings shown in the *User Preferences Default Table* on page 4-3 (also see Appendix A, *Standard Default Parameters* for all host device and miscellaneous scanner defaults). If the default values suit your requirements, programming may not be necessary.

Features values are set by scanning single bar codes or short bar code sequences. The settings are stored in non-volatile memory and are preserved even when the scanner is powered down.

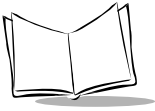

If you are not using a Synapse or USB cable you must select a host type (see each host chapter for specific host information). After you hear the power-up beeps, select a host type. This only needs to be done once, upon the first power-up when connected to a new host.

To return all features to their default values, all you need to do is scan the *Set All Defaults* bar code on page 4-4. Throughout the programming bar code menus, default values are indicated with asterisks (*).



* Indicates Default — * **High Frequency** — Feature/Option

Scanning Sequence Examples

In most cases you need only scan one bar code to set a specific parameter value. For example, if you want to set the beeper tone to high, simply scan the High Frequency (beeper tone) bar code listed under *Beeper Tone* on page 4-5. The scanner issues a fast warble beep and the LED turns green, signifying a successful parameter entry.

Other parameters, such as specifying Serial Response Time-Out or setting Data Transmission Formats, require that you scan several bar codes. Refer to *Laser On Time* on page 4-7 and *Scan Data Transmission Format* on page 13-6 for descriptions of this procedure.

Errors While Scanning

Unless otherwise specified, if you make an error during a scanning sequence, just re-scan the correct parameter.

User Preferences Default Parameters

Table 4-1 lists the defaults for user preferences parameters. If you wish to change any option, scan the appropriate bar code(s) provided in the User Preferences section beginning on page 4-4.

Note: See Appendix A, Standard Default Parameters for all user preferences, hosts, symbologies, and miscellaneous default parameters.

Table 4-1. User Preferences Default Table

Parameter	Default	Page Number
User Preferences		
Set Default Parameter	All Defaults	4-4
Beeper Tone	Medium	4-5
Beeper Volume	High	4-6
Power Mode	Continuous On	4-7
Laser On Time	3.0 Sec	4-8
Beep After Good Decode	Enable	4-9

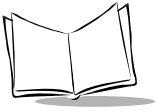

User Preferences

Set Default Parameter

Scanning this bar code returns all parameters to the default values listed in Table A-1 on page A-1.



Set All Defaults

Beeper Tone

To select a decode beep frequency (tone), scan the **Low Frequency**, **Medium Frequency**, or **High Frequency** bar code.

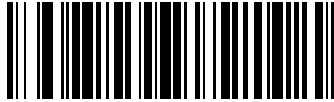

Low Frequency

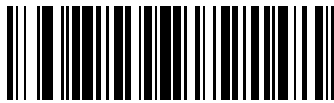

*** Medium Frequency
(Optimum Settings)**

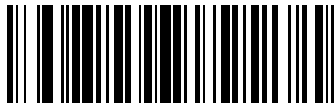

High Frequency

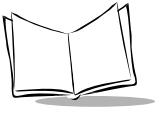

Beeper Volume

To select a beeper volume, scan the **Low Volume**, **Medium Volume**, or **High Volume** bar code.



Low Volume



Medium Volume



*** High Volume**

Power Mode

This parameter determines whether or not power remains on after a decode attempt. When in reduced power mode, the scanner enters into a low power consumption mode to preserve battery life after each decode attempt. When in continuous power mode, power remains on after each decode attempt.



***Continuous On**



Reduced Power Mode

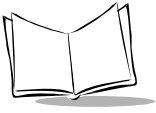

Laser On Time

This parameter sets the maximum time that decode processing continues during a scan attempt. It is programmable in 0.1 second increments from 0.5 to 9.9 seconds. The default Laser On Time is 3.0 seconds.

To set a Laser On Time, scan the bar code below. Next, scan two numeric bar codes beginning on page D-1 in Appendix D that correspond to the desired on time. Single digit numbers must have a leading zero. For example, to set an On Time of 0.5 seconds, scan the bar code below, then scan the “0” and “5” bar codes. If you make an error, or wish to change your selection, scan **Cancel** on page D-5.



Laser On Time

Beep After Good Decode

Scan a bar code below to select whether or not the scanner beeps after a good decode. If **Do Not Beep After Good Decode** is selected, the beeper still operates during parameter menu scanning and indicates error conditions.

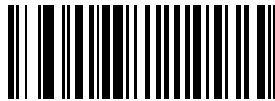

***Beep After Good Decode
(Enable)**

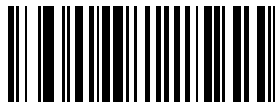

**Do Not Beep After Good Decode
(Disable)**

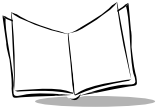

LS 2208 Product Reference Guide

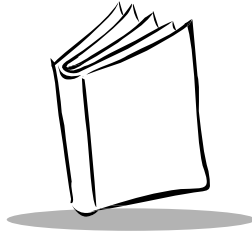

Chapter 5

Keyboard Wedge Interface

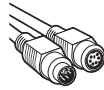

Introduction

This chapter covers Keyboard Wedge interface information for setting up your scanner. This interface type is used to attach the scanner between the keyboard and host computer. The scanner translates the bar code data into keystrokes. The host computer accepts the keystrokes as if they originate from the keyboard.

This mode of operation allows adding bar code reading functionality to a system designed for manual keyboard input. In this mode the keyboard keystrokes are simply passed through.

Throughout the programming bar code menus, default values are indicated with asterisks (*).



* Indicates Default — * **North American** — Feature/Option

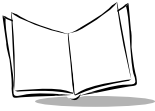

Connecting a Keyboard Wedge Interface

Male DIN Keyboard Connector to Host Connector to Host

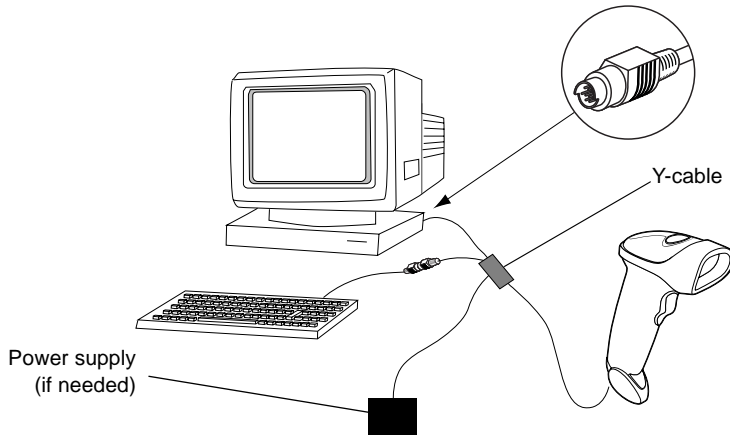

Figure 5-1. Keyboard Wedge Connection with Y-cable

To connect the Keyboard Wedge Y-cable:

1. Switch off the host and unplug the keyboard connector.
2. Attach the modular connector of the Y-cable to the cable interface port on the scanner. (See *Installing the Interface Cable* on page 1-3.)
3. Connect the round male DIN host connector of the Y-cable to the keyboard port on the host device.
4. Connect the round female DIN keyboard connector of the Y-cable to the keyboard.
5. If needed, attach the optional power supply to the connector in the middle of the Y-cable.
6. Ensure that all connections are secure.
7. Switch on your host system.
8. Scan the appropriate bar codes in this chapter to configure the scanner.



Keyboard Wedge Default Parameters

Table 5-1 lists the defaults for Keyboard Wedge host parameters. If you wish to change any option, scan the appropriate bar code(s) provided in the Keyboard Wedge Host Parameters section beginning on page 5-4.

Note: See Appendix A, *Standard Default Parameters for all user preferences, hosts, symbologies, and miscellaneous default parameters.*

Table 5-1. Keyboard Wedge Host Default Table

Parameter	Default	Page Number
Keyboard Wedge Host Parameters		
Keyboard Wedge Host Type	IBM PC/AT& IBM PC Compatibles ¹	5-4
Country Types (Country Codes)	North American	5-5
Ignore Unknown Characters	Transmit	5-8
Keystroke Delay	No Delay	5-9
Intra-Keystroke Delay	Disable	5-10
Alternate Numeric Keypad Emulation	Disable	5-10
Caps Lock On	Disable	5-11
Caps Lock Override	Disable	5-12
Convert Wedge Data	No Convert	5-12
Function Key Mapping	Disable	5-13
FN1 Substitution	Disable	5-14
Send and Make Break	Send	5-14
¹ User selection is required to configure this interface and this is the most common selection.		

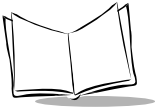

Keyboard Wedge Host Types

Keyboard Wedge Host Types

Select your keyboard wedge host by scanning one of the bar codes below.

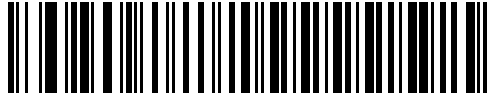

IBM PC/AT & IBM PC Compatibles¹

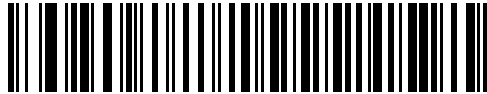

IBM PS/2 (Model 30)



IBM AT NOTEBOOK

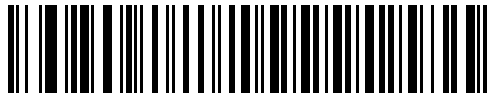

IBM XT

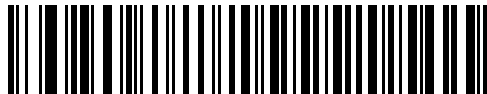

NCR 7052

Note: ¹User selection is required to configure this interface and this is the most common selection.



Keyboard Wedge Country Types (Country Codes)

Scan the bar code corresponding to your keyboard type. If your particular keyboard type is not listed, see *Alternate Numeric Keypad Emulation* on page 5-10.



***North American**



German Windows

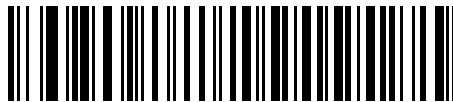

French Windows

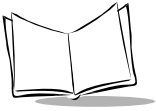

French Canadian Windows 95/98

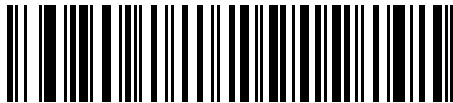

French Canadian Windows XP/2000



Keyboard Wedge Country Types (continued)



Spanish Windows



Italian Windows



Swedish Windows



UK English Windows



Japanese Windows

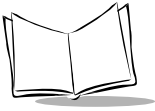

Keyboard Wedge Country Types (continued)



Portuguese-Brazilian Windows

Ignore Unknown Characters

Unknown characters are characters the host does not recognize. When **Send Bar Codes With Unknown Characters** is selected, all bar code data is sent except for unknown characters, and no error beeps sound on the scanner. When **Do Not Send Bar Codes With Unknown Characters** is selected, bar code data is sent up to the first unknown character and then an error beep will sound on the scanner.

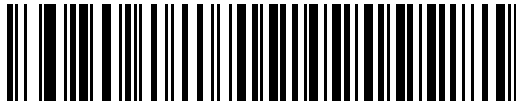

***Send Bar Codes with Unknown Characters
(Transmit)**

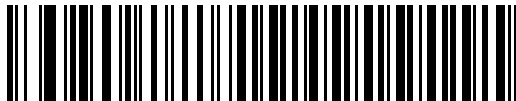

Do Not Send Bar Codes with Unknown Characters



Keystroke Delay

This is the delay in milliseconds between emulated keystrokes. Scan a bar code below to increase the delay when hosts require a slower transmission of data.



***No Delay**



Medium Delay (20 msec)



Long Delay (40 msec)

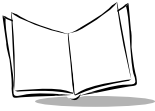

Intra-Keystroke Delay

When enabled, an additional delay is inserted between each emulated key depression and release. This sets the Keystroke Delay parameter to a minimum of 5 msec as well.



Enable

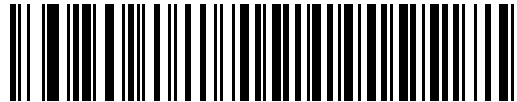

***Disable**

Alternate Numeric Keypad Emulation

This allows emulation of most other country keyboard types not listed in *Keyboard Wedge Country Types (Country Codes)* on page 5-5 in a Microsoft operating system environment.

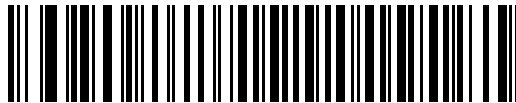

Enable Alternate Numeric Keypad



***Disable Alternate Numeric Keypad**



Caps Lock On

When enabled, the scanner emulates keystrokes as if the Caps Lock key is always pressed.

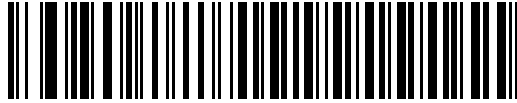

Enable Caps Lock On

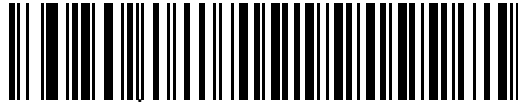

***Disable Caps Lock On**

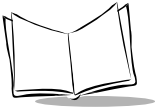

Caps Lock Override

When enabled, on AT or AT Notebook hosts, the keyboard ignores the state of the Caps Lock key. Therefore, an 'A' in the bar code is sent as an 'A' no matter what the state of the keyboard's Caps Lock key.

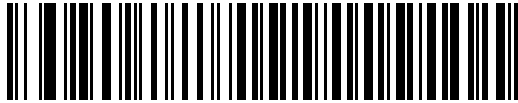

Enable Caps Lock Override

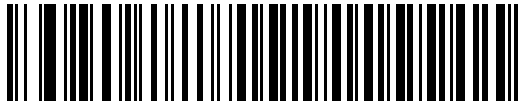

***Disable Caps Lock Override**

Note: *If both Caps Lock On and Caps Lock Override are enabled, Caps Lock Override takes precedence.*

Convert Wedge Data

When enabled, the scanner will convert all bar code data to the selected case.

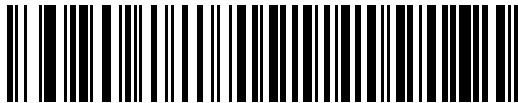

Convert to Upper Case



Convert to Lower Case

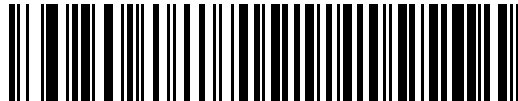

***No Convert**

Function Key Mapping

ASCII values under 32 are normally sent as control key sequences (see Table 5-2 on page 5-18). When this parameter is enabled, the keys in bold are sent in place of the standard key mapping. Table entries that do not have a bold entry remain the same whether or not this parameter is enabled.

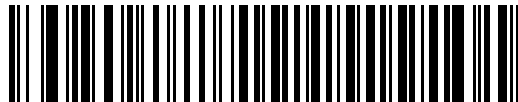

Enable

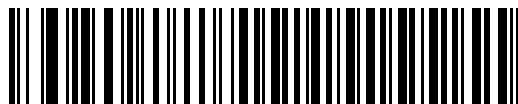

***Disable**

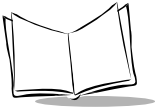

FN1 Substitution

When enabled, this parameter allows replacement of any FN1 characters in an EAN128 bar code with a keystroke chosen by the user.(see *FN1 Substitution Values* on page 13-9).

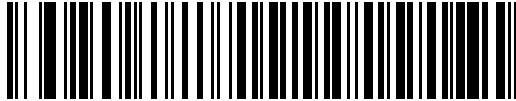

Enable



***Disable**

Send Make and Break

When enabled, the scan codes for releasing a key are not sent.



***Send Make and Break Scan Codes**



Send Make Scan Code Only



Keyboard Maps

The following keyboard maps are provided for prefix/suffix keystroke parameters. To program the prefix/suffix values, see the bar codes on page 13-5.

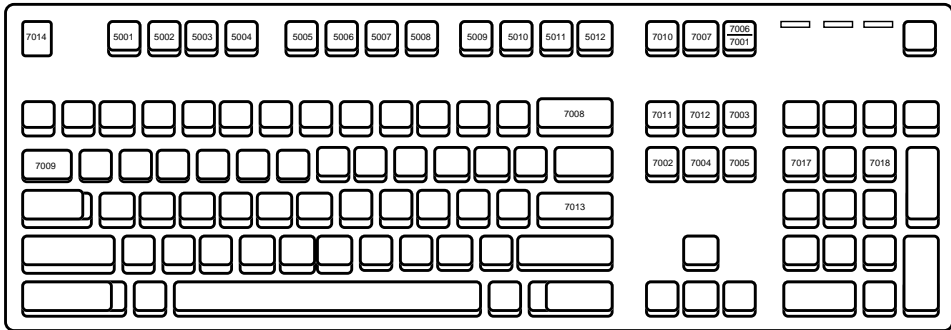

Figure 5-2. IBM PS2 Type Keyboard

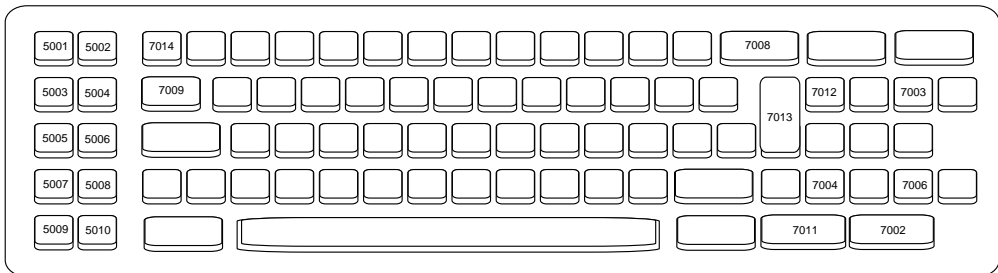

Figure 5-3. IBM PC/XT

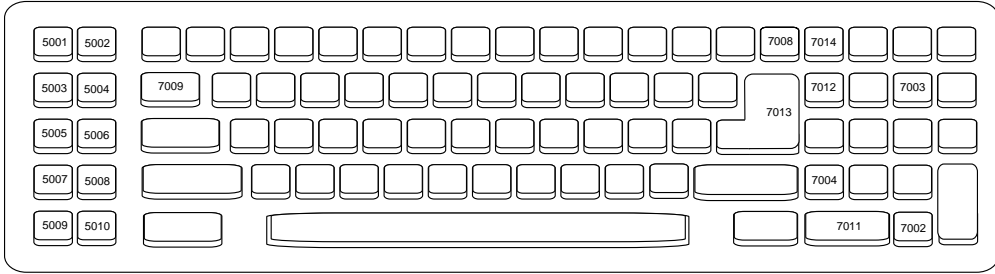
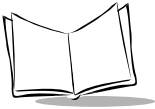

Figure 5-4. IBM PC/AT

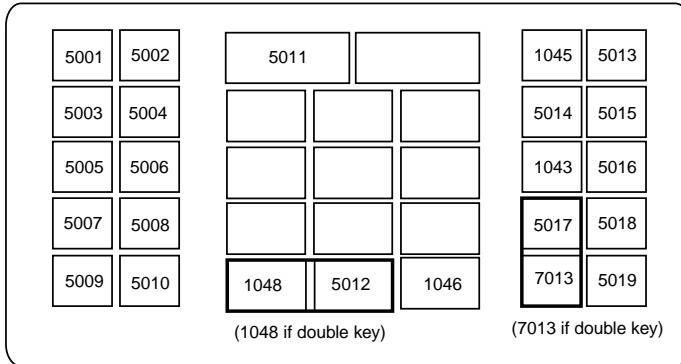

Figure 5-5. NCR 7052 32-KEY

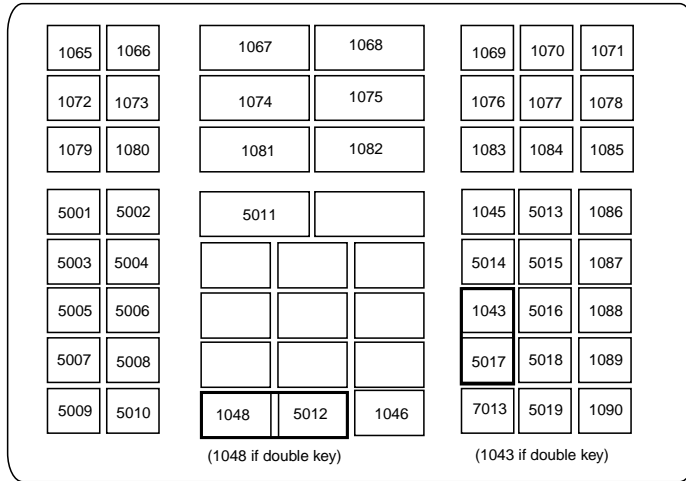
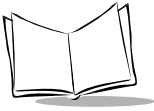

Figure 5-6. NCR 7052 58-KEY



ASCII Character Set

Note: Code 39 Full ASCII interprets the bar code special character (\$ + % /) preceding a Code 39 character and assigns an ASCII character value to the pair. For example, when Code 39 Full ASCII is enabled and a +B is scanned, it is interpreted as b, %J as ?, and %V as @. Scanning ABC%I outputs the keystroke equivalent of ABC >.

Table 5-2. Keyboard Wedge ASCII Character Set

ASCII Value	Full ASCII Code 39 Encode Char.	Keystroke
1001	\$A	CTRL A
1002	\$B	CTRL B
1003	\$C	CTRL C
1004	\$D	CTRL D
1005	\$E	CTRL E
1006	\$F	CTRL F
1007	\$G	CTRL G
1008	\$H	CTRL H/ BACKSPACE ¹
1009	\$I	CTRL I/ HORIZONTAL TAB ¹
1010	\$J	CTRL J
1011	\$K	CTRL K
1012	\$L	CTRL L
1013	\$M	CTRL M/ ENTER ¹
1014	\$N	CTRL N

**Table 5-2. Keyboard Wedge ASCII Character Set (Continued)**

1015	\$O	CTRL O
1016	\$P	CTRL P
1017	\$Q	CTRL Q
1018	\$R	CTRL R
1019	\$S	CTRL S
1020	\$T	CTRL T
1021	\$U	CTRL U
1022	\$V	CTRL V
1023	\$W	CTRL W
1024	\$X	CTRL X
1025	\$Y	CTRL Y
1026	\$Z	CTRL Z
1027	%A	CTRL [/ESC ¹
1028	%B	CTRL \
1029	%C	CTRL]
1030	%D	CTRL 6
1031	%E	CTRL -
1032	Space	Space
1033	/A	!
1034	/B	"
1035	/C	#
1036	/D	\$
1037	/E	%
1038	/F	&
1039	/G	'
1040	/H	(
1041	/I)

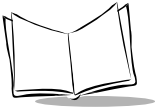

Table 5-2. Keyboard Wedge ASCII Character Set (Continued)

1042	/J	*
1043	/K	+
1044	/L	,
1045	-	-
1046	.	.
1047	/O	/
1048	0	0
1049	1	1
1050	2	2
1051	3	3
1052	4	4
1053	5	5
1054	6	6
1055	7	7
1056	8	8
1057	9	9
1058	/Z	:
1059	%F	;
1060	%G	<
1061	%H	=
1062	%I	>
1063	%J	?
1064	%V	@
1065	A	A
1066	B	B
1067	C	C
1068	D	D

**Table 5-2. Keyboard Wedge ASCII Character Set (Continued)**

1069	E	E
1070	F	F
1071	G	G
1072	H	H
1073	I	I
1074	J	J
1075	K	K
1076	L	L
1077	M	M
1078	N	N
1079	O	O
1080	P	P
1081	Q	Q
1082	R	R
1083	S	S
1084	T	T
1085	U	U
1086	V	V
1087	W	W
1088	X	X
1089	Y	Y
1090	Z	Z
1091	%K	[
1092	%L	\
1093	%M]
1094	%N	^
1095	%O	_

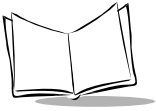

Table 5-2. Keyboard Wedge ASCII Character Set (Continued)

1096	%W	'
1097	+A	a
1098	+B	b
1099	+C	c
1100	+D	d
1101	+E	e
1102	+F	f
1103	+G	g
1104	+H	h
1105	+I	i
1106	+J	j
1107	+K	k
1108	+L	l
1109	+M	m
1110	+N	n
1111	+O	o
1112	+P	p
1113	+Q	q
1114	+R	r
1115	+S	s
1116	+T	t
1117	+U	u
1118	+V	v
1119	+W	w
1120	+X	x
1121	+Y	y
1122	+Z	z



Table 5-2. Keyboard Wedge ASCII Character Set (Continued)

1123	%P	{
1124	%Q	
1125	%R	}
1126	%S	~
ALT Keys	Keystroke	
2065	ALT A	
2066	ALT B	
2067	ALT C	
2068	ALT D	
2069	ALT E	
2070	ALT F	
2071	ALT G	
2072	ALT H	
2073	ALT I	
2074	ALT J	
2075	ALT K	
2076	ALT L	
2077	ALT M	
2078	ALT N	
2079	ALT O	
2080	ALT P	
2081	ALT Q	
2082	ALT R	
2083	ALT S	
2084	ALT T	
2085	ALT U	
2086	ALT V	

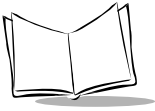

Table 5-2. Keyboard Wedge ASCII Character Set (Continued)

2087	ALT W
2088	ALT X
2089	ALT Y
2090	ALT Z
GUI Keys	Keystrokes
3000	Right Control Key
3048	GUI 0
3049	GUI 1
3050	GUI 2
3051	GUI 3
3052	GUI 4
3053	GUI 5
3054	GUI 6
3055	GUI 7
3056	GUI 8
3057	GUI 9
3065	GUI A
3066	GUI B
3067	GUI C
3068	GUI D
3069	GUI E
3070	GUI F
3071	GUI G
3072	GUI H
3073	GUI I
3074	GUI J
3075	GUI K

**Table 5-2. Keyboard Wedge ASCII Character Set (Continued)**

3076	GUI L
3077	GUI M
3078	GUI N
3079	GUI O
3080	GUI P
3081	GUI Q
3082	GUI R
3083	GUI S
3084	GUI T
3085	GUI U
3086	GUI V
3087	GUI W
3088	GUI X
3089	GUI Y
3090	GUI Z
F Keys	Keystroke
5001	F1
5002	F2
5003	F3
5004	F4
5005	F5
5006	F6
5007	F7
5008	F8
5009	F9
5010	F10
5011	F11

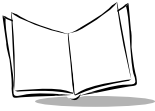
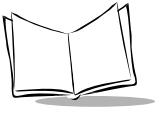

Table 5-2. Keyboard Wedge ASCII Character Set (Continued)

5012	F12
5013	F13
5014	F14
5015	F15
5016	F16
5017	F17
5018	F18
5019	F19
5020	F20
5021	F21
5022	F22
5023	F23
5024	F24
Numeric Keypad	Keystroke
6042	*
6043	+
6044	undefined
6045	-
6046	.
6047	/
6048	0
6049	1
6050	2
6051	3
6052	4
6053	5
6054	6

Table 5-2. Keyboard Wedge ASCII Character Set (Continued)

6055	7
6056	8
6057	9
6058	Enter
6059	Num Lock
Extended Keypad	Keystroke
7001	Break
7002	Delete
7003	Pg Up
7004	End
7005	Pg Dn
7006	Pause
7007	Scroll Lock
7008	Backspace
7009	Tab
7010	Print Screen
7011	Insert
7012	Home
7013	Enter
7014	Escape
7015	Up Arrow
7016	Dn Arrow
7017	Left Arrow
7018	Right Arrow
The keystroke in bold is sent only if the “Function Key Mapping” is enabled. Otherwise, the unbolden keystroke is sent.	



LS 2208 Product Reference Guide

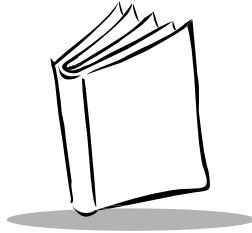

Chapter 6

RS-232 Interface



Introduction

This chapter covers RS-232 host information for setting up your scanner. The RS-232 interface is used to attach the scanner to point-of-sale devices, host computers, or other devices with an available RS-232 port (e.g., com port).

If your particular host is not listed in Table 6-2, you need to set the communication parameters to match your host device. To set communication parameters for hosts not listed, refer to the documentation for the host device.

Note: *This scanner utilizes TTL RS-232 signal levels, which will interface with most system architectures. For system architectures requiring RS-232C signal levels, Symbol offers different cables providing the TTL to RS-232C conversion. Please contact your Symbol Support Center for more information.*

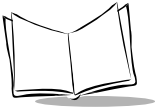

Throughout the programming bar code menus, default values are indicated with asterisks (*).



* Indicates Default — * **Baud Rate 9600** — Feature/Option

Connecting an RS-232 Interface

This connection is made directly from the scanner to the host computer.

Serial Port Connector to Host

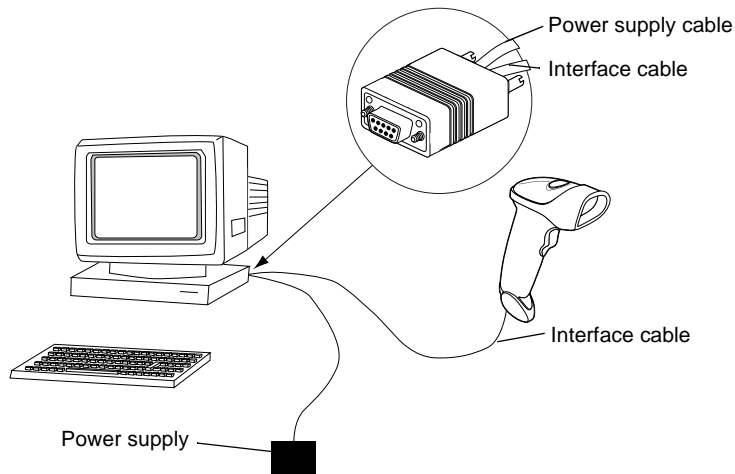

Figure 6-1. RS-232 Direct Connection

1. Connect the RS-232 interface cable to the bottom of the scanner, as described in *Installing the Interface Cable* on page 1-3.
2. Connect the other end of the interface cable to the serial port on the host.
3. Connect the power supply.
4. Scan appropriate bar codes in this chapter to match your host settings.

RS-232 Default Parameters

Table 6-1 lists the defaults for RS-232 host parameters. If you wish to change any option, scan the appropriate bar code(s) provided in the Parameter Descriptions section beginning on page 6-5.

Note: See Appendix A, Standard Default Parameters for all user preferences, hosts, symbologies, and miscellaneous default parameters.

Table 6-1. RS-232 Host Default Table

Parameter	Default	Page Number
RS-232 Host Parameters		
RS-232 Host Types	Standard ¹	6-7
Baud Rate	9600	6-10
Parity Type	None	6-12
Stop Bit Select	1 Stop Bit	6-13
Data Bits	8-Bit	6-13
Check Receive Errors	Enable	6-14
Hardware Handshaking	None	6-16
Software Handshaking	None	6-17
Host Serial Response Time-out	2 Sec	6-20
RTS Line State	Low RTS	6-21
Beep on <BEL>	Disable	6-21
Intercharacter Delay	0 msec	6-22
Nixdorf Beep/LED Options	Normal Operation	6-23

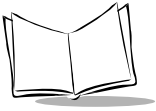

Table 6-1. RS-232 Host Default Table (Continued)

Parameter	Default	Page Number
Ignore Unknown Characters	Send Bar Code	6-24
¹ User selection is required to configure this interface and this is the most common selection.		



RS-232 Host Parameters

Various RS-232 hosts are set up with their own parameter default settings (Table 6-2). Selecting the ICL, Fujitsu, Wincor-Nixdorf Mode A, Wincor-Nixdorf Mode B, Olivetti, Omron, or terminal sets the defaults listed below.

Table 6-2. Terminal Specific RS-232

Parameter	Standard (Default)	ICL	Fujitsu	Wincor-Nixdorf Mode A	Wincor-Nixdorf Mode B/ OPOS	Olivetti	Omron
Transmit Code ID	No	Yes	Yes	Yes	Yes	Yes	Yes
Data Transmission Format	Data as is	Data/Suffix	Data/Suffix	Data/Suffix	Data/Suffix	Prefix/Data/Suffix	Data/Suffix
Suffix	CR/LF (7013)	CR (1013)	CR (1013)	CR (1013)	CR (1013)	ETX (1002)	CR (1013)
Baud Rate	9600	9600	9600	9600	9600	9600	9600
Parity	None	Even	None	Odd	Odd	Even	None
Hardware Handshaking	None	RTS/CTS Option 3	None	RTS/CTS Option 3	RTS/CTS Option 3	None	None
Software Handshaking	None	None	None	None	None	Ack/Nak	None
Serial Response Time-out	2 Sec.	9.9 Sec.	2 Sec.	9.9 Sec.	9.9 Sec.	9.9 Sec.	9.9 Sec.
Stop Bit Select	One	One	One	One	One	One	One
ASCII Format	8-Bit	8-Bit	8-Bit	8-Bit	8-Bit	7-Bit	8-Bit
Beep On <BEL>	Disable	Disable	Disable	Disable	Disable	Disable	Disable
RTS Line State	Low	High	Low	Low	Low = No data to send	Low	High
Prefix	None	None	None	None	None	STX (1003)	None

*In the Nixdorf Mode B, if CTS is Low, scanning is disabled. When CTS is High, the user can scan bar codes.

**If Nixdorf Mode B is scanned without the scanner connected to the proper host, it may appear unable to scan. If this happens, scan a different RS-232 host type within 5 seconds of cycling power to the scanner.

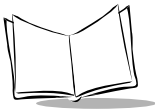

RS-232 Host Parameters (continued)

Selecting the ICL, Fujitsu, Wincor-Nixdorf Mode A, Wincor-Nixdorf Mode B, OPOS terminal enables the transmission of code ID characters listed in Table 6-3 below. These code ID characters are not programmable and are separate from the Transmit Code ID feature. The Transmit Code ID feature should not be enabled for these terminals.

Table 6-3. Terminal Specific Code ID Characters

	ICL	Fujitsu	Wincor-Nixdorf Mode A	Wincor-Nixdorf Mode B/OPOS	Olivetti	Omron
UPC-A	A	A	A	A	A	A
UPC-E	E	E	C	C	C	E
EAN-8/JAN-8	FF	FF	B	B	B	FF
EAN-13/JAN-13	F	F	A	A	A	F
Code 39	C <len>	None	M	M	M <len>	C <len>
Codabar	N <len>	None	N	N	N <len>	N <len>
Code 128	L <len>	None	K	K	K <len>	L <len>
I 2 of 5	I <len>	None	I	I	I <len>	I <len>
Code 93	None	None	L	L	L <len>	None
D 2 of 5	H <len>	None	H	H	H <len>	H <len>
UCC/EAN 128	L <len>	None	P	P	P <len>	L <len>
MSI	None	None	O	O	O <len>	None
Bookland EAN	F	F	A	A	A	F
Trioptic	None	None	None	None	None	None
Code 11	None	None	None	None	None	None
IATA	H<len>	None	H	H	None	None
Code 32	None	None	None	None	None	None



RS-232 Host Types

To select an RS-232 host interface, scan one of the following bar codes.



Standard RS-232¹

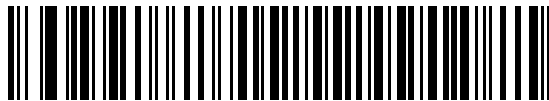

ICL RS-232

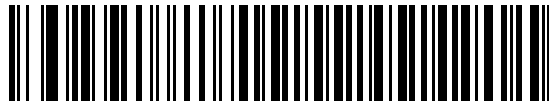

Wincor-Nixdorf RS-232 Mode A

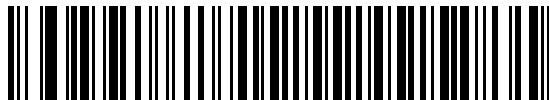

Wincor-Nixdorf RS-232 Mode B



Olivetti ORS4500

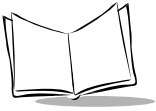

Omron

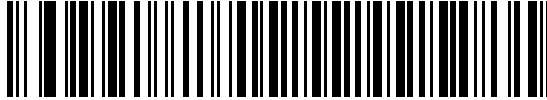

OPOS/JPOS

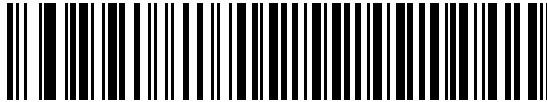

Fujitsu RS-232

Note: ¹User selection is required to configure this interface and this is the most common selection.

Baud Rate

Baud rate is the number of bits of data transmitted per second. The scanner's baud rate setting should match the baud rate setting of the host device. If not, data may not reach the host device or may reach it in distorted form.



Baud Rate 600



Baud Rate 1200



Baud Rate 2400



Baud Rate 4800

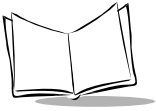

Baud Rate (continued)



***Baud Rate 9600**



Baud Rate 19,200



Baud Rate 38,400



Parity

A parity check bit is the most significant bit of each ASCII coded character. Select the parity type according to host device requirements.

Select **Odd** parity and the parity bit value is set to 0 or 1, based on data, to ensure that an odd number of 1 bits are contained in the coded character.

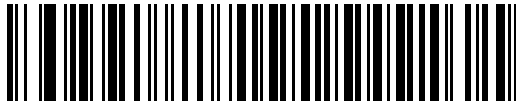

Odd

Select **Even** parity and the parity bit value is set to 0 or 1, based on data, to ensure that an even number of 1 bits are contained in the coded character.

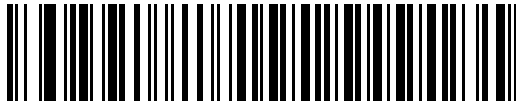

Even

Select **Mark** parity and the parity bit is always 1.



Mark

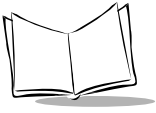

Parity (continued)

Select **Space** parity and the parity bit is always 0.

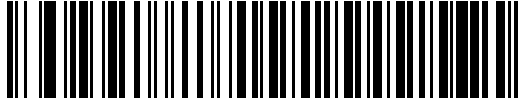

Space

Select **None** when no parity bit is required.

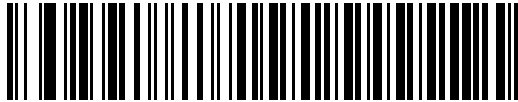

***None**



Stop Bit Select

The stop bit(s) at the end of each transmitted character marks the end of transmission of one character and prepares the receiving device for the next character in the serial data stream. The number of stop bits selected (one or two) depends on the number the receiving terminal is programmed to accommodate. Set the number of stop bits to match host device requirements.

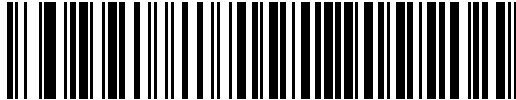

***1 Stop Bit**



2 Stop Bits

Data Bits

This parameter allows the scanner to interface with devices requiring a 7-bit or 8-bit ASCII protocol.



7-Bit



***8-Bit**

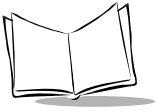

Check Receive Errors

Select whether or not the parity, framing, and overrun of received characters are checked. The parity value of received characters is verified against the parity parameter selected above.

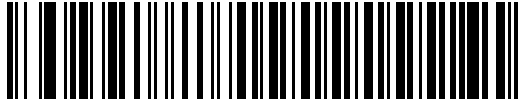

***Check For Received Errors**

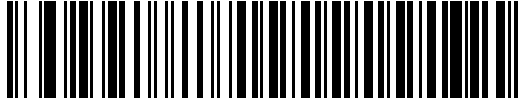

Do Not Check For Received Errors



Hardware Handshaking

The data interface consists of an RS-232 port designed to operate either with or without the hardware handshaking lines, *Request to Send (RTS)*, and *Clear to Send (CTS)*.

If Standard RTS/CTS handshaking is not selected, scan data is transmitted as it becomes available. If Standard RTS/CTS handshaking is selected, scan data is transmitted according to the following sequence:

- The scanner reads the CTS line for activity. If CTS is asserted, the scanner waits up to Host Serial Response Time-out for the host to negate the CTS line. If, after Host Serial Response Time-out (default), the CTS line is still asserted, the scanner sounds a transmit error, and any scanned data is lost
- When the CTS line is negated, the scanner asserts the RTS line and waits up to Host Serial Response Time-out for the host to assert CTS. When the host asserts CTS, data is transmitted. If, after Host Serial Response Time-out (default), the CTS line is not asserted, the scanner sounds a transmit error, and discards the data
- When data transmission is complete, the scanner negates RTS 10 msec after sending the last character
- The host should respond by negating CTS. The scanner checks for a negated CTS upon the next transmission of data.

During the transmission of data, the CTS line should be asserted. If CTS is deasserted for more than 50 ms between characters, the transmission is aborted, the scanner sounds a transmission error, and the data is discarded.

If the above communications sequence fails, the scanner issues an error indication. In this case, the data is lost and must be rescanned.

If Hardware Handshaking and Software Handshaking are both enabled, Hardware Handshaking takes precedence.

Note: *The DTR signal is jumpered to the active state.*

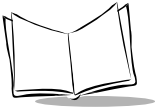

None

Scan the bar code below if no Hardware Handshaking is desired.

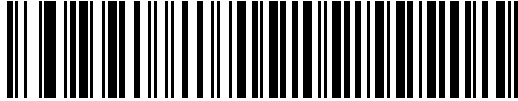

***None**

Standard RTS/CTS

Scan the bar code below to select Standard RTS/CTS Hardware Handshaking.

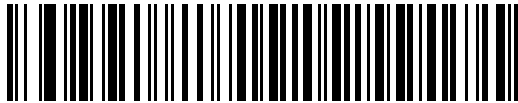

Standard RTS/CTS

RTS/CTS Option 1

When RTS/CTS Option 1 is selected, the scanner asserts RTS before transmitting and ignores the state of CTS. The scanner de-asserts RTS when the transmission is complete.

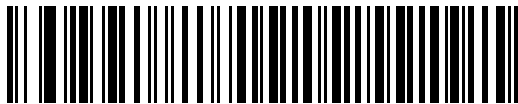

RTS/CTS Option 1

RTS/CTS Option 2

When Option 2 is selected, RTS is always high or low (user-programmed logic level). However, the scanner waits for CTS to be asserted before transmitting data. If CTS is not asserted within Host Serial Response Time-out (default), the scanner issues an error indication and discards the data.



RTS/CTS Option 2



RTS/CTS Option 3

When Option 3 is selected, the scanner asserts RTS prior to any data transmission, regardless of the state of CTS. The scanner waits up to Host Serial Response Time-out (default) for CTS to be asserted. If CTS is not asserted during this time, the scanner issues an error indication and discards the data. The scanner de-asserts RTS when transmission is complete.



RTS/CTS Option 3

Software Handshaking

This parameter offers control of the data transmission process in addition to, or instead of, that offered by hardware handshaking. There are five options.

If Software Handshaking and Hardware Handshaking are both enabled, Hardware Handshaking takes precedence.

None

When this option is selected, data is transmitted immediately. No response is expected from host.

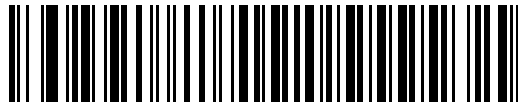

***None**

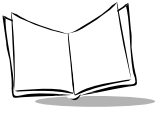

ACK/NAK

When this option is selected, after transmitting data, the scanner expects either an ACK or NAK response from the host. When a NAK is received, the scanner transmits the same data again and waits for either an ACK or NAK. After three unsuccessful attempts to send data when NAKs are received, the scanner issues an error indication and discards the data.

The scanner waits up to the programmable Host Serial Response Time-out to receive an ACK or NAK. If the scanner does not get a response in this time, it issues an error indication and discards the data. There are no retries when a time-out occurs.

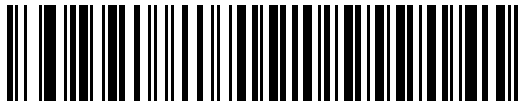

ACK/NAK

ENQ

When this option is selected, the scanner waits for an ENQ character from the host before transmitting data. If an ENQ is not received within the Host Serial Response Time-out, the scanner issues an error indication and discards the data. The host must transmit an ENQ character at least every Host Serial Response Time-out to prevent transmission errors.



ENQ



ACK/NAK with ENQ

This combines the two previous options. For re-transmissions of data, due to a NAK from the host, an additional ENQ is not required.

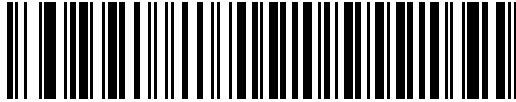

ACK/NAK with ENQ

XON/XOFF

An XOFF character turns the scanner transmission off until the scanner receives an XON character. There are two situations for XON/XOFF:

- XOFF is received before the scanner has data to send. When the scanner has data to send, it waits up to Host Serial Response Time-out for an XON character before transmission. If the XON is not received within this time, the scanner issues an error indication and discards the data.
- XOFF is received during a transmission. Data transmission then stops after sending the current byte. When the scanner receives an XON character, it sends the rest of the data message. The scanner waits up to 30 seconds for the XON.

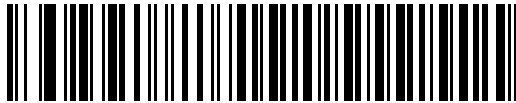

XON/XOFF

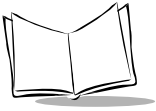

Host Serial Response Time-out

This parameter specifies how long the scanner waits for an ACK, NAK, or CTS before determining that a transmission error has occurred. This only applies when in one of the ACK/NAK Software Handshaking modes, or RTS/CTS Hardware Handshaking option.

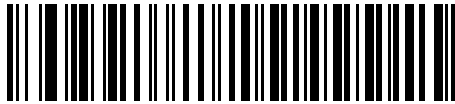

***Minimum: 2 Sec**



Low: 2.5 Sec



Medium: 5 Sec



High: 7.5 Sec



Maximum: 9.9 Sec



RTS Line State

This parameter sets the idle state of the Serial Host RTS line. Scan a bar code below to select **Low RTS** or **High RTS** line state.

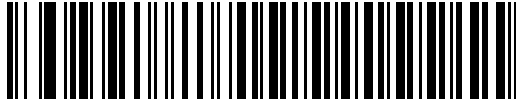

***Host: Low RTS**



Host: High RTS

Beep on <BEL>

When this parameter is enabled, the scanner issues a beep when a <BEL> character is detected on the RS-232 serial line. <BEL> is issued to gain a user's attention to an illegal entry or other important event.

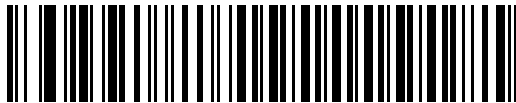

**Beep On <BEL> Character
(Enable)**



***Do Not Beep On <BEL> Character
(Disable)**

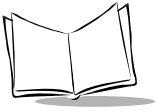

Intercharacter Delay

This parameter specifies the intercharacter delay inserted between character transmissions.



***Minimum: 0 msec**



Low: 25 msec



Medium: 50 msec



High: 75 msec



Maximum: 99 msec



Nixdorf Beep/LED Options

When Nixdorf Mode B is selected, this indicates when the scanner should beep and turn on its LED after a decode.



***Normal Operation
(Beep/LED immediately after decode)**

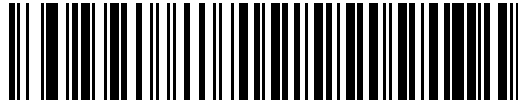

Beep/LED After Transmission

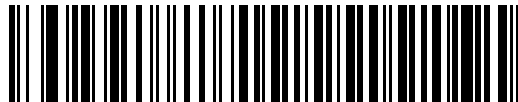

Beep/LED After CTS Pulse

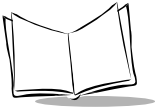

Ignore Unknown Characters

Unknown characters are characters the host does not recognize. When Send Bar Codes with Unknown Characters is selected, all bar code data is sent except for unknown characters, and no error beeps sound on the scanner. When Do Not Send Bar Codes With Unknown Characters is selected, bar code data is sent up to the first unknown character and then an error beep will sound on the scanner.

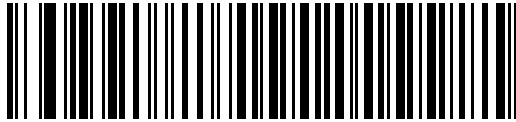

***Send Bar Code**
(with unknown characters)



Do Not Send Bar Codes
(with unknown characters)

ASCII / Character Set

The values in Table 6-4 can be assigned as prefixes or suffixes for ASCII character data transmission.

Table 6-4. Prefix/Suffix Values

Prefix/Suffix Value	Full ASCII Code 39 Encode Character	ASCII Character
1000	%U	NUL
1001	\$A	SOH
1002	\$B	STX
1003	\$C	ETX
1004	\$D	EOT
1005	\$E	ENQ
1006	\$F	ACK
1007	\$G	BELL
1008	\$H	BCKSPC
1009	\$I	HORIZ TAB
1010	\$J	LF/NW LN
1011	\$K	VT
1012	\$L	FF
1013	\$M	CR/ENTER
1014	\$N	SO
1015	\$O	SI
1016	\$P	DLE
1017	\$Q	DC1/XON
1018	\$R	DC2
1019	\$S	DC3/XOFF
1020	\$T	DC4
1021	\$U	NAK

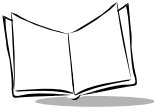

Table 6-4. Prefix/Suffix Values (Continued)

Prefix/Suffix Value	Full ASCII Code 39 Encode Character	ASCII Character
1022	\$V	SYN
1023	\$W	ETB
1024	\$X	CAN
1025	\$Y	EM
1026	\$Z	SUB
1027	%A	ESC
1028	%B	FS
1029	%C	GS
1030	%D	RS
1031	%E	US
1032	Space	Space
1033	/A	!
1034	/B	"
1035	/C	#
1036	/D	\$
1037	/E	%
1038	/F	&
1039	/G	'
1040	/H	(
1041	/I)
1042	/J	*
1043	/K	+
1044	/L	,
1045	-	-
1046	.	.
1047	/O	/



Table 6-4. Prefix/Suffix Values (Continued)

Prefix/Suffix Value	Full ASCII Code 39 Encode Character	ASCII Character
1048	0	0
1049	1	1
1050	2	2
1051	3	3
1052	4	4
1053	5	5
1054	6	6
1057	7	7
1056	8	8
1057	9	9
1058	/Z	:
1059	%F	;
1060	%G	<
1061	%H	=
1062	%I	>
1063	%J	?
1064	%V	@
1065	A	A
1066	B	B
1067	C	C
1068	D	D
1069	E	E
1070	F	F
1071	G	G
1072	H	H
1073	I	I

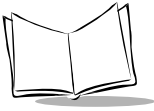

Table 6-4. Prefix/Suffix Values (Continued)

Prefix/Suffix Value	Full ASCII Code 39 Encode Character	ASCII Character
1074	J	J
1075	K	K
1076	L	L
1077	M	M
1078	N	N
1079	O	O
1080	P	P
1081	Q	Q
1082	R	R
1083	S	S
1084	T	T
1085	U	U
1086	V	V
1087	W	W
1088	X	X
1089	Y	Y
1090	Z	Z
1091	%K	[
1092	%L	\
1093	%M]
1094	%N	^
1095	%O	_
1096	%W	'
1097	+A	a
1098	+B	b
1099	+C	c



Table 6-4. Prefix/Suffix Values (Continued)

Prefix/Suffix Value	Full ASCII Code 39 Encode Character	ASCII Character
1100	+D	d
1101	+E	e
1102	+F	f
1103	+G	g
1104	+H	h
1105	+I	i
1106	+J	j
1107	+K	k
1108	+L	l
1109	+M	m
1110	+N	n
1111	+O	o
1112	+P	p
1113	+Q	q
1114	+R	r
1115	+S	s
1116	+T	t
1117	+U	u
1118	+V	v
1119	+W	w
1120	+X	x
1121	+Y	y
1122	+Z	z
1123	%P	{
1124	%Q	
1125	%R	}

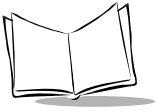
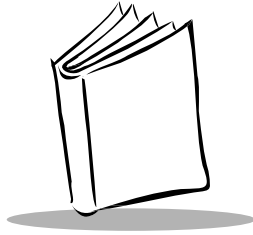

Table 6-4. Prefix/Suffix Values (Continued)

Prefix/Suffix Value	Full ASCII Code 39 Encode Character	ASCII Character
1126	%S	~
1127		Undefined
7013		ENTER



Chapter 7

USB Interface

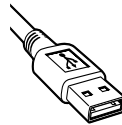

Introduction

This chapter covers the connection and setup of the scanner to a USB host. The scanner attaches directly to a USB host, or a powered USB hub, and is powered by it. No additional power supply is required.

Throughout the programming bar code menus, default values are indicated with asterisks (*).



* Indicates Default —* North American Standard USB Keyboard — Feature/Option

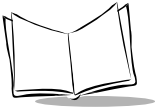

Connecting a USB Interface

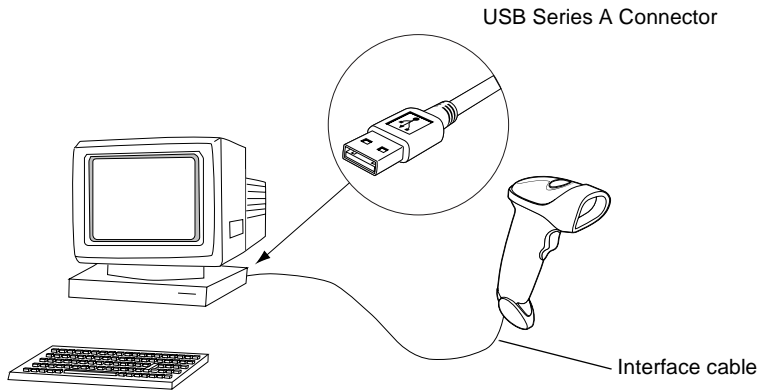

Figure 7-1. USB Connection

The scanner connects with USB capable hosts including:

- Desktop PCs and Notebooks
- Apple™ iMac, G4, iBooks (North America only)
- IBM SurePOS terminals
- Sun, IBM, and other network computers that support more than one keyboard.

The following operating systems support the scanner through USB:

- Windows 98, 2000, ME, XP
- MacOS 8.5 and above
- IBM 4690 OS.

The scanner will also interface with other USB hosts which support USB Human Interface Devices (HID). For more information on USB technology, hosts, and peripheral devices, visit www.symbol.com/usb.

To set up your scanner:

1. Connect the USB interface cable to the bottom of the scanner, as described in *Installing the Interface Cable* on page 1-3.



2. Plug the series A connector in the USB host or hub, or plug the Plus Power connector in an available port of the IBM SurePOS terminal.
 3. Select the USB device type. See *USB Device Type* on page 7-5.
 4. On first installation when using Windows, the software prompts you to select or install the "Human Interface Device" driver. To install the "Human Interface Device" driver provided by Windows click "Next" through all the choices and click "Finished" on the last choice. The scanner powers up during this installation.
 5. If you are not using a North American keyboard, scan the appropriate country bar code under *USB Country Keyboard Types (Country Codes)* on page 7-6.
- If you are having any problems with your system, see *Troubleshooting* on page 3-2.

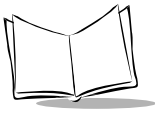

USB Default Parameters

Table 7-1 lists the defaults for USB host parameters. If you wish to change any option, scan the appropriate bar code(s) provided in the Parameter Descriptions section beginning on page 7-5.

Note: See Appendix A, *Standard Default Parameters for all user preferences, hosts, symbologies, and miscellaneous default parameters.*

Table 7-1. USB Host Default Table

Parameter	Default	Page Number
USB Host Parameters		
USB Device Type	HID Keyboard Emulation	7-5
USB Country Keyboard Types (Country Codes)	North American	7-6
USB Keystroke Delay	No Delay	7-9
USB CAPS Lock Override	Disable	7-10
USB Ignore Unknown Characters	Enable	7-11
Emulate Keypad	Disable	7-12
USB FN1 Substitution	Disable	7-12
Function Key Mapping	Disable	7-13
Simulated Caps Lock	Disable	7-13
Convert Case	None	7-14

USB Host Parameters

USB Device Type

Select the desired USB device type.

Note: *When changing USB Device Types, the scanner automatically restarts. The scanner issues the standard startup beep sequences.*

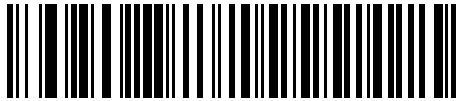

***HID Keyboard Emulation**

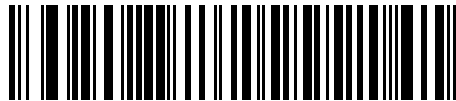

IBM Table Top USB



IBM Hand-Held USB

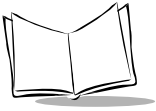

USB Country Keyboard Types (Country Codes)

Scan the bar code corresponding to your keyboard type. This setting applies only to the USB HID Keyboard Emulation device.

Note: *When changing Country Selection, the scanner automatically restarts. The scanner issues the standard startup beep sequences.*



***North American Standard USB Keyboard**

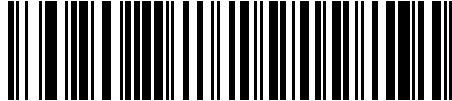

German Windows



French Windows



USB Country Keyboard Types (continued)



French Canadian Windows 95/98



French Canadian Windows 2000/XP

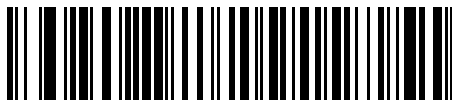

Spanish Windows



Italian Windows

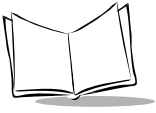

USB Country Keyboard Types (continued)



Swedish Windows

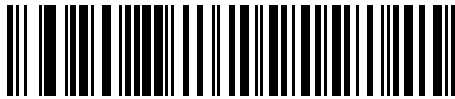

UK English Windows



Japanese Windows (ASCII)



Portuguese-Brazilian Windows



USB Keystroke Delay

This parameter sets the delay, in milliseconds, between emulated keystrokes. Scan a bar code below to increase the delay when hosts require a slower transmission of data.



*** No Delay**



Medium Delay (20 msec)



Long Delay (40 msec)

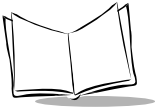

USB CAPS Lock Override

This option applies only to the HID Keyboard Emulation device. When enabled, the case of the data is preserved regardless of the state of the caps lock key. This setting is always enabled for the “Japanese, Windows (ASCII)” keyboard type and can not be disabled.

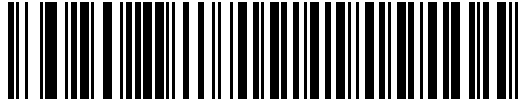

**Override Caps Lock Key
(Enable)**

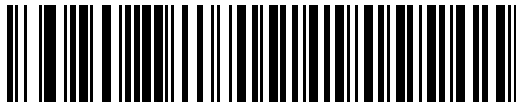

***Do Not Override Caps Lock Key
(Disable)**



USB Ignore Unknown Characters

This option applies only to the HID Keyboard Emulation device and IBM device. Unknown characters are characters the host does not recognize. When “Send Bar Codes With Unknown Characters” is selected, all bar code data is sent except for unknown characters, and no error beeps sound. When “Do Not Send Bar Codes With Unknown Characters” is selected, bar codes containing at least one unknown character are not sent to the host, and an error beep sounds.

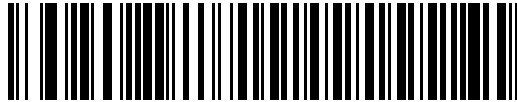

***Send Bar Codes with Unknown Characters
(Transmit)**

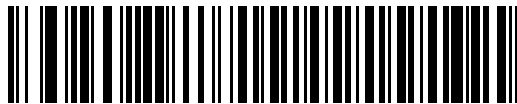

**Do Not Send Bar Codes with Unknown Characters
(Disable)**

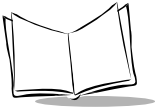

Emulate Keypad

When enabled, all characters are sent as ASCII sequences over the numeric keypad. For example ASCII A would be sent as “ALT make” 0 6 5 “ALT Break”.



***Disable Keypad Emulation**

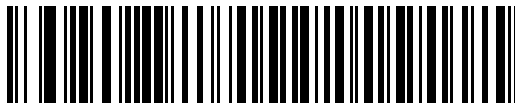

Enable Keypad Emulation

USB Keyboard FN 1 Substitution

This option applies only to the USB HID Keyboard Emulation device. When enabled, this allows replacement of any FN 1 characters in an EAN 128 bar code with a Key Category and value chosen by the user (see FN 1 Substitution Values on page 13-9 to set the Key Category and Key Value).

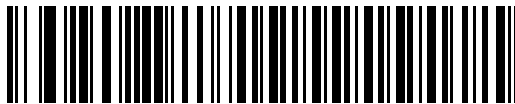

Enable

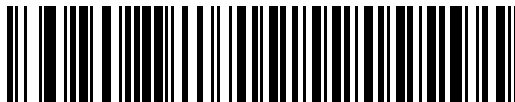

***Disable**

Function Key Mapping

ASCII values under 32 are normally sent as a control-key sequences (see Table 7-2 on page 7-15). When this parameter is enabled, the keys in bold are sent in place of the standard key mapping. Table entries that do not have a bold entry remain the same whether or not this parameter is enabled.

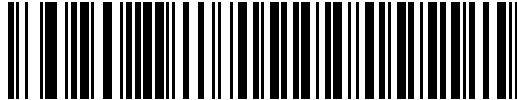

***Disable Function Key Mapping**



Enable Function Key Mapping

Simulated Caps Lock

When enabled, the scanner will invert upper and lower case characters on the scanner bar code as if the Caps Lock state is enabled on the keyboard. This inversion is done regardless of the current state of the keyboard's Caps Lock state.



***Disable Simulated Caps Lock**



Enable Simulated Caps Lock

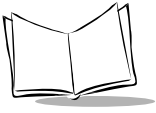

Convert Case

When enabled, the scanner will convert all bar code data to the selected case.

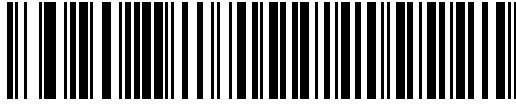

***No Case Conversion**

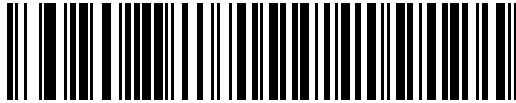

Convert All to Upper Case

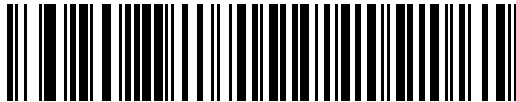

Convert All to Lower Case

ASCII Character Set

Table 7-2. USB ASCII Character Set

Prefix/ Suffix Value	Full ASCII Code 39 Encode Char.	Keystroke
1000	%U	CTRL 2
1001	\$A	CTRL A
1002	\$B	CTRL B
1003	\$C	CTRL C
1004	\$D	CTRL D
1005	\$E	CTRL E
1006	\$F	CTRL F
1007	\$G	CTRL G
1008	\$H	CTRL H/ BACKSPACE ¹
1009	\$I	CTRL I/ HORIZONTAL TAB ¹
1010	\$J	CTRL J
1011	\$K	CTRL K
1012	\$L	CTRL L
1013	\$M	CTRL M/ ENTER ¹
1014	\$N	CTRL N
1015	\$O	CTRL O
1016	\$P	CTRL P
1017	\$Q	CTRL Q
1018	\$R	CTRL R
1019	\$S	CTRL S
1020	\$T	CTRL T
1021	\$U	CTRL U
1022	\$V	CTRL V
1023	\$W	CTRL W

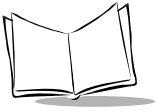

Table 7-2. USB ASCII Character Set (Continued)

1024	\$X	CTRL X
1025	\$Y	CTRL Y
1026	\$Z	CTRL Z
1027	%A	CTRL [/ ESC ¹
1028	%B	CTRL \
1029	%C	CTRL]
1030	%D	CTRL 6
1031	%E	CTRL -
1032	Space	Space
1033	/A	!
1034	/B	"
1035	/C	#
1036	/D	\$
1037	/E	%
1038	/F	&
1039	/G	'
1040	/H	(
1041	/I)
1042	/J	*
1043	/K	+
1044	/L	,
1045	-	-
1046	.	.
1047	/O	/
1048	0	0
1049	1	1
1050	2	2

**Table 7-2. USB ASCII Character Set (Continued)**

1051	3	3
1052	4	4
1053	5	5
1054	6	6
1055	7	7
1056	8	8
1057	9	9
1058	/Z	:
1059	%F	;
1060	%G	<
1061	%H	=
1062	%I	>
1063	%J	?
1064	%V	@
1065	A	A
1066	B	B
1067	C	C
1068	D	D
1069	E	E
1070	F	F
1071	G	G
1072	H	H
1073	I	I
1074	J	J
1075	K	K
1076	L	L
1077	M	M

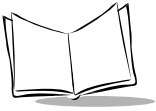

Table 7-2. USB ASCII Character Set (Continued)

1078	N	N
1079	O	O
1080	P	P
1081	Q	Q
1082	R	R
1083	S	S
1084	T	T
1085	U	U
1086	V	V
1087	W	W
1088	X	X
1089	Y	Y
1090	Z	Z
1091	%K	[
1092	%L	\
1093	%M]
1094	%N	^
1095	%O	_
1096	%W	'
1097	+A	a
1098	+B	b
1099	+C	c
1100	+D	d
1101	+E	e
1102	+F	f
1103	+G	g
1104	+H	h



Table 7-2. USB ASCII Character Set (Continued)

1105	+I	i
1106	+J	j
1107	+K	k
1108	+L	l
1109	+M	m
1110	+N	n
1111	+O	o
1112	+P	p
1113	+Q	q
1114	+R	r
1115	+S	s
1116	+T	t
1117	+U	u
1118	+V	v
1119	+W	w
1120	+X	x
1121	+Y	y
1122	+Z	z
1123	%P	{
1124	%Q	
1125	%R	}
1126	%S	~
ALT Keys	Keystroke	
2064	ALT 2	
2065	ALT A	
2066	ALT B	
2067	ALT C	

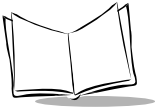

Table 7-2. USB ASCII Character Set (Continued)

2068	ALT D
2069	ALT E
2070	ALT F
2071	ALT G
2072	ALT H
2073	ALT I
2074	ALT J
2075	ALT K
2076	ALT L
2077	ALT M
2078	ALT N
2079	ALT O
2080	ALT P
2081	ALT Q
2082	ALT R
2083	ALT S
2084	ALT T
2085	ALT U
2086	ALT V
2087	ALT W
2088	ALT X
2089	ALT Y
2090	ALT Z
GUI Shift Keys	
The Apple™ iMac keyboard has an apple key on either side of the space bar. Windows-based systems have a GUI key to the left of the left ALT key, and to the right of the right ALT key.	
Other Value	Keystroke

**Table 7-2. USB ASCII Character Set (Continued)**

3000	Right Control Key
3048	GUI 0
3049	GUI 1
3050	GUI 2
3051	GUI 3
3052	GUI 4
3053	GUI 5
3054	GUI 6
3055	GUI 7
3056	GUI 8
3057	GUI 9
3065	GUI A
3066	GUI B
3067	GUI C
3068	GUI D
3069	GUI E
3070	GUI F
3071	GUI G
3072	GUI H
3073	GUI I
3074	GUI J
3075	GUI K
3076	GUI L
3077	GUI M
3078	GUI N
3079	GUI O
3080	GUI P

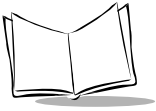

Table 7-2. USB ASCII Character Set (Continued)

3081	GUI Q
3082	GUI R
3083	GUI S
3084	GUI T
3085	GUI U
3086	GUI V
3087	GUI W
3088	GUI X
3089	GUI Y
3090	GUI Z
F Keys	Keystroke
5001	F1
5002	F2
5003	F3
5004	F4
5005	F5
5006	F6
5007	F7
5008	F8
5009	F9
5010	F10
5011	F11
5012	F 12
5013	F 13
5014	F 14
5015	F 15
5016	F16

**Table 7-2. USB ASCII Character Set (Continued)**

5017	F 17
5018	F 18
5019	F 19
5020	F 20
5021	F 21
5022	F 22
5023	F 23
5024	F 24
Keypad	Keystroke
6042	*
6043	+
6044	undefined
6045	-
6046	.
6047	/
6048	0
6049	1
6050	2
6051	3
6052	4
6053	5
6054	6
6055	7
6056	8
6057	9
6058	Enter
6059	Num Lock

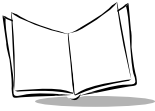

Table 7-2. USB ASCII Character Set (Continued)

Extended Keypad	Keystroke
7001	Break
7002	Delete
7003	PgUp
7004	End
7005	Pg Dn
7006	Pause
7007	Scroll Lock
7008	Backspace
7009	Tab
7010	Print Screen
7011	Insert
7012	Home
7013	Enter
7014	Escape
7015	Up Arrow
7016	Down Arrow
7017	Left Arrow
7018	Right Arrow
The keystroke in bold is sent only if the "Function Key Mapping" is enabled. Otherwise, the unbolden keystroke is sent.	



Chapter 8

IBM 468X/469X Interface

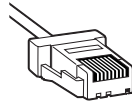

Introduction

This chapter covers IBM 468X/469X host information for setting up your scanner.

Throughout the programming bar code menus, default values are indicated with asterisks (*).



* Indicates Default — * **Disable Convert to** — Feature/Option
Code 39

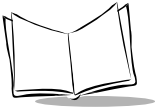

Connecting to an IBM 468X/469X Host

This connection is made directly from the scanner to the host interface.

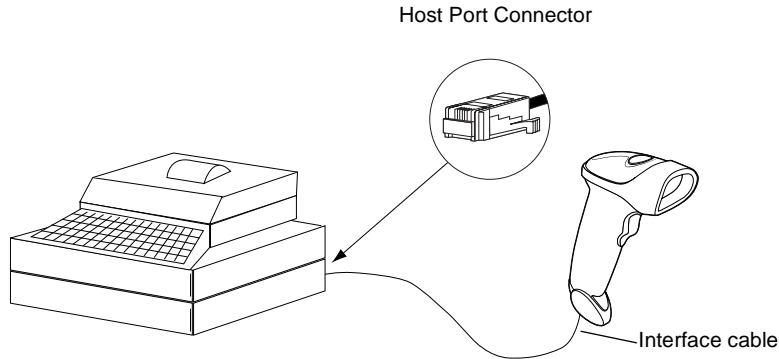
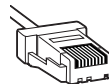

Figure 8-1. IBM Direct Connection

1. Connect the interface cable to the bottom of the scanner, as described in *Installing the Interface Cable* on page 1-3.
2. Connect the other end of the interface cable to the appropriate port on the host (typically, Port 9).
3. Scan the appropriate bar codes in this chapter to configure the scanner.

Note: *The only required configuration is the port number. Most other scanner parameters are typically controlled by the IBM system.*



IBM Default Parameters

Table 8-1 lists the defaults for IBM host parameters. If you wish to change any option, scan the appropriate bar code(s) provided in the Parameter Descriptions section beginning on page 8-4.

Note: See Appendix A, *Standard Default Parameters for all user preferences, hosts, symbologies, and miscellaneous default parameters.*

Table 8-1. IBM Host Default Table

Parameter	Default	Page Number
IBM 468X/469X Host Parameters		
Port Address	None Selected	8-4
Convert Unknown to Code 39	Disable	8-5

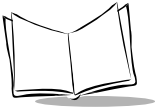

IBM 468X/469X Host Parameters

Port Address

This parameter sets the IBM 468X/469X port being used.

Note: Scanning one of these bar codes enables the RS-485 interface on the scanner.

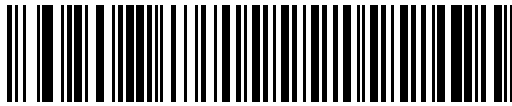

* None Selected

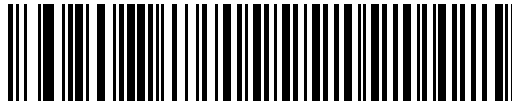

Hand-held Scanner Emulation (Port 9B)¹



Non-IBM Scanner Emulation (Port 5B)

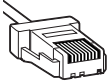

Port Address (continued)

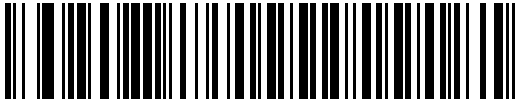

Table-top Scanner Emulation (Port 17)

Note: ¹User selection is required to configure this interface and this is the most common selection.

Convert Unknown to Code 39

Scan a bar code below to enable or disable the conversion of unknown bar code type data to Code 39.



Enable Convert Unknown to Code 39



*Disable Convert Unknown to Code 39

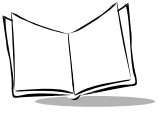

LS 2208 Product Reference Guide

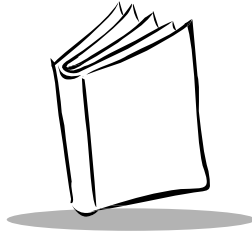

Chapter 9

Wand Emulation Interface

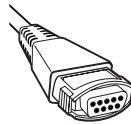

Introduction

This chapter covers Wand Emulation host information for setting up your scanner. This mode is used whenever Wand Emulation communication is needed. The scanner will attach either to an external wand decoder or to a decoder integrated in a portable terminal or Point-of-Sale (POS) terminal.

In this mode the scanner emulates the signal of a digital wand to make it "readable" by a wand decoder.

Throughout the programming bar code menus, default values are indicated with asterisks (*).



* Indicates Default — * **Transmit Unknown Characters** — Feature/Option

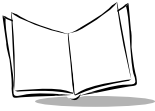

Connecting Using Wand Emulation

To perform Wand Emulation, connect the scanner to a portable data terminal, or a controller which collects the wand data and interprets it for the host.

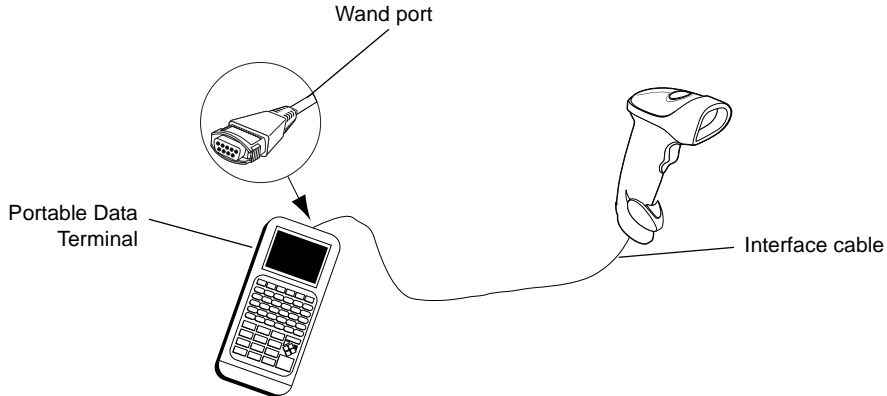

Figure 9-1. Wand Emulation Connection

1. Connect the Wand Emulation interface cable to the bottom of the scanner, as described in *Installing the Interface Cable* on page 1-3.
2. Connect the other end of the interface cable to the Wand port on the portable data terminal or controller.
3. Scan the appropriate bar codes in this chapter to configure the scanner.



Wand Emulation Default Parameters

Table 9-1 lists the defaults for Wand Emulation host types. If you wish to change any option, scan the appropriate bar code(s) provided in the Wand Emulation Host Parameters section beginning on page 9-4.

Note: See Appendix A, *Standard Default Parameters for all user preferences, hosts, symbologies, and miscellaneous default parameters.*

Table 9-1. Wand Emulation Default Table

Parameter	Default	Page Number
Wand Emulation Host Parameters		
Wand Emulation Host Types	Symbol OmniLink Interface Controller ¹	9-4
Leading Margin	80 msec	9-5
Polarity	Bar High/Margin Low	9-6
Ignore Unknown Characters	Ignore	9-7
Convert All Bar Codes to Code 39	Disable	9-7
Convert Code 39 to Full ASCII	Disable	9-8
¹ User selection is required to configure this interface and this is the most common selection.		

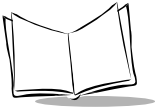

Wand Emulation Host Parameters

Wand Emulation Host Types

Select your wand emulation host by scanning one of the bar codes below.

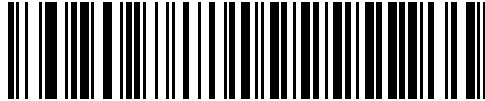

Symbol OmniLink Interface Controller¹

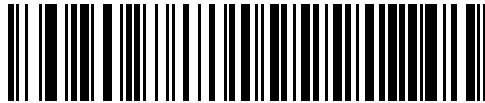

Symbol PDT Terminal (MSI)



Symbol PTC Terminal (Telxon)

Note: ¹User selection is required to configure this interface and this is the most common selection.



Leading Margin (Quiet Zone)

Scan a bar code below to select a leading margin duration. A leading margin is the time that precedes the first bar of the scan, (in milliseconds). The minimum allowed value is 80 msec and the maximum is 250 msec. This parameter is used to accommodate older wand decoders which cannot handle short leading margins.

Note: 250 msec is the maximum value that this parameter can attain, however, 200 msec is sufficient.



*80 msec



140 msec



200 msec

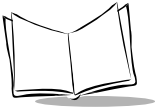

Polarity

Polarity determines how the scanner's wand emulation interface creates the Digitized Barcode Pattern (DBP). DBP is a digital signal that represents the scanned bar code. Different decoders, to which this device could be attached, are expecting the DBP to be in a certain format. The DBP either has the "highs" represent bars and the "lows" represent spaces (margins), or the "highs" represent spaces (margins) and the "lows" represent bars.

Scan the appropriate bar code below to select the polarity required by your decoder.



***Bar High/Margin Low**



Bar Low/Margin High



Ignore Unknown Characters

Unknown characters are characters the host does not recognize. When **Send Bar Codes With Unknown Characters** is selected, all bar code data is sent except for unknown characters, and no error beeps sound on the scanner. When **Do Not Send Bar Codes With Unknown Characters** is selected, bar codes containing at least one unknown character are not sent to the host, and an error beep will sound on the scanner.



***Send Bar Codes With Unknown Characters
(Transmit)**



**Do Not Send Bar Codes With Unknown Characters
(Do Not Transmit)**

Convert All Bar Codes to Code 39

By default, the Wand Emulation Interface sends data to the attached host in the same symbology that was decoded. This may present a problem for customers with older systems that do not recognize some newer symbologies (for example, RSS).

Enabling this parameter ignores the original symbology that was decoded, and outputs the data as if it were a Code 39 barcode. Any lowercase characters that were in the original data stream are transmitted as uppercase characters. This also allows ADF Formatting to occur.

If **Ignore Unknown Characters** is enabled, any characters that do not have a corresponding character in the Code 39 symbology set are replaced by a space.

If **Ignore Unknown Characters** is disabled, if any characters that do not have a corresponding character are encountered, the scanner emits an error beep and no data is transmitted.

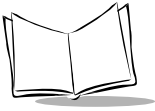

ADF Note: By default, the Wand Emulation Interface does not allow scanned data to be processed by ADF rules. Enabling this parameter has the side effect of allowing the scanned data to be processed by the ADF rules (Chapter 14, *Advanced Data Formatting*).

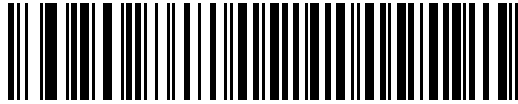

Enable Convert to Code 39 for Wand Host

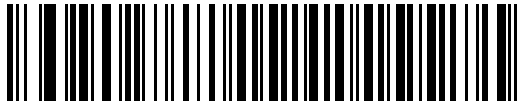

***Disable Convert to Code 39 for Wand Host**

Convert Code 39 to Full ASCII

By default, any characters that do not have a corresponding character in the Code 39 symbology set are replaced by a space. If this parameter is enabled, the data sent to the Wand Interface will be encoded in Code 39 Full ASCII. This setting requires that the Host be able to interpret Code 39 Full ASCII data.

This setting applies only if **Convert to Code 39** is also enabled.

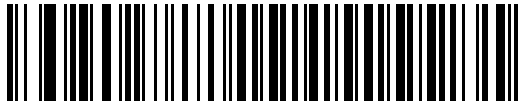

***Disable Code 39 Full ASCII Conversion**



Enable Code 39 Full ASCII Conversion

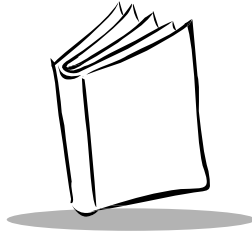

Chapter 10

Undecoded Scanner Emulation Interface

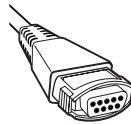

Introduction

This chapter covers Undecoded Scanner Emulation host information for setting up your scanner. This mode is used whenever Undecoded Scanner Emulation communication is needed. When Undecoded Scanner Emulation is used, the scanner will attach either to an external decoder or to a decoder integrated in a portable terminal or Point-of-Sale (POS) terminal.

Throughout the programming bar code menus, default values are indicated with asterisks (*).



* Indicates Default — * **Parameter Process** — Feature/Option
and Pass-Through

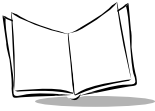

Connecting Using Undecoded Scanner Emulation

To perform Undecoded Scanner Emulation, connect the scanner to a portable data terminal, or a controller which collects the data and interprets it for the host.

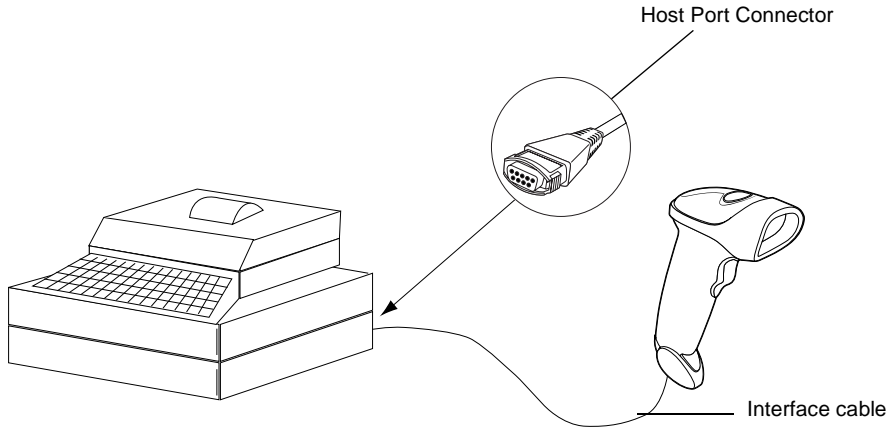

Figure 10-1. Undecoded Scanner Emulation Connection

1. Connect the Undecoded interface cable to the bottom of the scanner, as described in *Installing the Interface Cable* on page 1-3.
2. Connect the other end of the interface cable to the scanner port on the portable data terminal or controller.
3. Scan the appropriate bar codes in this chapter to configure the scanner.

WARNING

The scanner should only be connected to 5 volt decoders. Connecting the scanner to a 12 volt decoder will invalidate your warranty.



Undecoded Scanner Emulation Default Parameters

Table 10-1 lists the defaults for the Undecoded Scanner Emulation Host. If you wish to change any option, scan the appropriate bar code(s) provided in the Undecoded Scanner Host Parameters section beginning on page 10-5.

Note: See Appendix A, Standard Default Parameters for all user preferences, hosts, symbologies, and miscellaneous default parameters.

Table 10-1. Undecoded Scanner Emulation Default Table

Parameter	Default	Page Number
Beep Style	Beep on Successful Transmit	10-5
Parameter Pass-Through	Parameter Process and Pass Through	10-6
Convert Newer Code Types	Convert Newer Code Types	10-7
Module Width	20 μ s	10-8
Convert All Bar Codes to Code 39	Do Not Convert to Bar Codes to Code 39	10-9
Code 39 Full ASCII Conversion	Disable	10-9
Transmission Timeout	3 seconds	10-10
Ignore Unknown Characters	Ignore Unknown Characters	10-11
Leading Margin	2 ms	10-12
Check for Decode LED	Check for Decode LED	10-13
¹ User selection is required to configure this interface and this is the most common selection.		

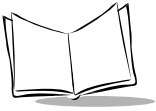

Undecoded Scanner Emulation Host

Scan the bar code below to enable the Undecoded Scanner Emulation Host.



Undecoded Scanner Emulation Host



Undecoded Scanner Emulation Host Parameters

Beep Style

The Undecoded Scanner Emulation Host supports three different beep styles.

The default is to beep when the attached decoder issues the decode signal to the scanner. This way, the scanner and the attached decoder beep at the same time.

The second option is to beep on the scanner's decode. This results in a double beep sequence from most decoders, since the scanner beeps, and the decoder beeps (at a different frequency) when it successfully decodes the output.

The third option is to not beep at all since the attached decoder issues the decode beep.

In all cases, if an error condition is encountered, the scanner issues error beeps.



***Beep On Successful Transmit**



Beep At Decode Time



Do Not Beep

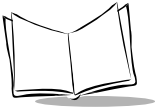

Parameter Pass-Through

The Undecoded Scanner Emulation Host has the ability to process parameter barcode messages and send them to the attached decoder. In this way, customers using Symbol compliant decoders can control the behavior of the entire system by scanning the necessary parameters only once.

Note:Enabling D 2 of 5, for example, can be performed simply by scanning the "D 2 of 5 Enable" parameter barcode on the Scanner. The scanner and the attached decoder will both process the parameter.



***Parameter Process and Pass-Through**



Parameter Process Only



Convert Newer Code Types

The LS2208 supports a variety of code types that are customarily not decodable by attached decoder systems. To allow compatibility in these environments, the scanner converts these code types to more commonly decodable symbologies, as per the following chart. Symbologies not listed on this chart are transmitted normally.

Scan this code type:	Transmitted as:
Code 11	Code 39
Chinese 2 of 5	Code 39
RSS (14, Limited, and Expanded)	Code 128
Coupon Code	Code 128

When decoding these code types with this parameter disabled, the scanner issues Convert Error beeps and transmits no data.



***Convert Newer Code Types**



Reject Newer Code Types

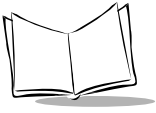

Module Width

The standard module width is 20 μ s.

In the case of an extremely slow decoder system, this module width can be extended to 50 μ s through use of this parameter.



***20 μ s Module Width**



50 μ s Module Width



Convert All Bar Codes to Code 39

Scan the appropriate bar code below to enable or disable the conversion of all bar code data to Code 39.



***Do Not Convert Bar Codes To Code 39**



Convert All To Code 39

Code 39 Full ASCII Conversion

By default, any characters that do not have a corresponding character in the Code 39 symbology set are replaced by a space. If this parameter is enabled, the data sent to the Undecoded Scanner Emulation Host will be encoded in Code 39 Full ASCII. This setting requires that the Host be able to interpret Code 39 Full ASCII data.

This setting applies only if **Convert to Code 39** is also enabled.



***Disable Convert Code 39 To Full ASCII**



Enable Convert Code 39 To Full ASCII

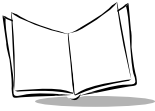

Transmission Timeout

The Undecoded Scanner Emulation Host transmits barcode data to the attached decoder and waits for the attached decoder to assert the Decode signal, indicating successful transmission. If, after a specified amount of time, the Decode signal has not been asserted (indicating that the attached decoder has not successfully received the barcode data), the scanner issues Transmit Error beeps.

Scan the appropriate bar code below to select the desired transmission timeout.



***3 Second Transmission Timeout**



4 Second Transmission Timeout



5 Second Transmission Timeout



10 Second Transmission Timeout



Transmission Timeout (Continued)



30 Second Transmission Timeout

Ignore Unknown Characters

Unknown characters are characters that the decoder does not recognize. When "Ignore Unknown Characters" is selected, all bar code data is sent except for unknown characters, and no error beeps are sounded. When "Convert Error on Unknown Characters" is selected, bar codes containing at least one unknown character are not sent to the decoder, and a Convert Error beep is sounded.



***Ignore Unknown Characters**



Convert Error On Unknown Characters

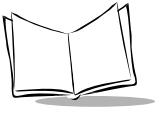

Leading Margin

Scan a bar code below to select a leading margin duration.



1 ms Leading Margin



***2 ms Leading Margin**



3 ms Leading Margin



5 ms Leading Margin



10 ms Leading Margin



Check For Decode LED

The attached decoder normally asserts the Decode line to signal to the Undecoded Scanner Emulation Host that it has successfully decoded the transmitted barcode. Some decoders, however, do not assert the Decode signal to tell the scanner that a decode has occurred. In this case, the scanner emits Transmit Error beeps to indicate that the barcode was not successfully transmitted. Scanning the "Ignore Decode LED" bar code below to disable the Transmit Error beeps.



***Check For Decode LED**



Ignore Decode LED

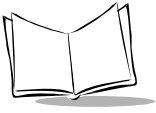

LS 2208 Product Reference Guide

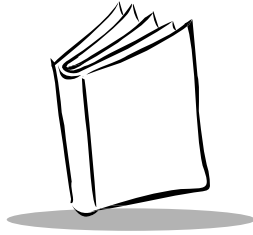

Chapter 11

123Scan

Introduction

This chapter includes the bar code you must scan to use the 123Scan program.

123Scan is a Windows[®] based utility that allows the scanner to be setup and programmed with all parameters including Advanced Data Formatting (ADF) Rules. An ADF rule allows bar code data to be modified before it is sent on to the host. This ensures compatibility between bar coded data and the host application; the scanner is programmed rather than modifying the host software. Scanners can be programmed via PC download or by scanning a sheet of bar codes generated by the utility. Scanner programming is saved in a file that can be distributed electronically by e-mail. A help file is built into the program 123Scan.

Communication With the 123Scan PC Based Configuration Tool

In order to communicate with the 123Scan program, which runs on a PC with Windows, use an RS-232 cable to connect the scanner to the PC (see *Connecting an RS-232 Interface* on page 6-2).

You will need:

- PC with Windows
- Scanner
- RS-232 cable.

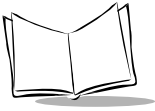

123Scan Parameter

In order to communicate with the 123Scan program, load 123Scan, included in the documentation CD-ROM, onto your PC and scan the bar code below. Refer to 123Scan instructions for programming your scanner.

Note: *Scanning this bar code enables the 123Scan interface on the scanner.*

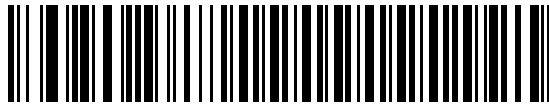

123Scan Configuration

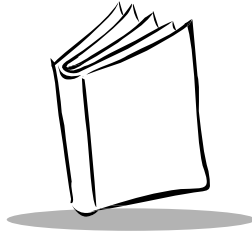

Chapter 12

Symbologies

Introduction

This chapter describes all symbology features and provides the programming bar codes necessary for selecting these features for your LS 2208 scanner. Before programming, follow the instructions in Chapter 1, *Getting Started*.

Your scanner is shipped with the settings shown in the *Symbology Default Table* on page 12-3 (also see Appendix A, *Standard Default Parameters* for all host device and miscellaneous scanner defaults). If the default values suit your requirements, programming may not be necessary. Features values are set by scanning single bar codes or short bar code sequences.

To return all features to their default values, all you need to do is scan the *Set All Defaults* bar code on page 4-4.

If you are not using a Synapse or USB cable you must select a host type. Refer to each host chapter for specific host information.

Scanning Sequence Examples

In most cases you need only scan one bar code to set a specific parameter value. For example, if you want to transmit bar code data without the UPC-A check digit, simply scan the **Do Not Transmit UPC-A Check Digit** bar code listed under *Transmit UPC-A/UPC-E/UPC-E1 Check Digit* on page 12-14. The scanner issues a fast warble beep and the LED turns green, signifying a successful parameter entry.

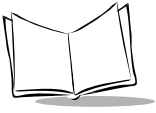

Other parameters, such as **Set Length(s) for D 2 of 5** require that you scan several bar codes in the proper sequence. Refer to the individual parameter, like **Set Length(s) for D 2 of 5**, for this procedure.

Errors While Scanning

Unless otherwise specified, if you make an error during a scanning sequence, just re-scan the correct parameter.

Symbology Default Parameters

Table 12-1 lists the defaults for all symbologies parameters. If you wish to change any option, scan the appropriate bar code(s) provided in the Symbologies Parameters section beginning on 12-7.

Note: See Appendix A, Standard Default Parameters for all user preferences, hosts, symbologies, and miscellaneous default parameters.

Table 12-1. Symbology Default Table

Parameter	Default	Page Number
UPC/EAN		
UPC-A	Enable	12-7
UPC-E	Enable	12-7
UPC-E1	Disable	12-8
EAN-8/JAN 8	Enable	12-9
EAN-13/JAN 13	Enable	12-9
Bookland EAN	Disable	12-10
Decode UPC/EAN/JAN Supplementals (2 and 5 digits)	Ignore	12-12
UPC/EAN/JAN Supplemental Redundancy	7	12-13
Transmit UPC-A Check Digit	Enable	12-14
Transmit UPC-E Check Digit	Enable	12-14
Transmit UPC-E1 Check Digit	Enable	12-15

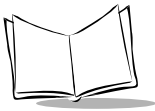

Table 12-1. Symbology Default Table (Continued)

Parameter	Default	Page Number
UPC-A Preamble	System Character	12-16
UPC-E Preamble	System Character	12-16
UPC-E1 Preamble	System Character	12-18
Convert UPC-E to A	Disable	12-20
Convert UPC-E1 to A	Disable	12-20
EAN-8/JAN-8 Extend	Disable	12-21
UPC/EAN Security Levels	0	12-22
UCC Coupon Extended Code	Disable	12-24
Code 128		
Code 128	Enable	12-25
UCC/EAN-128	Enable	12-26
Code 39		
Code 39	Enable	12-27
Trioptic Code 39	Disable	12-28
Convert Code 39 to Code 32 (Italian Pharmacy Code)	Disable	12-29
Code 32 Prefix	Disable	12-30
Set Length(s) for Code 39	2 to 55	12-31
Code 39 Check Digit Verification	Disable	12-33
Transmit Code 39 Check Digit	Disable	12-34
Code 39 Full ASCII Conversion	Disable	12-35

Table 12-1. Symbology Default Table (Continued)

Parameter	Default	Page Number
Buffer Code 39	Disable	12-36
Code 93		
Code 93	Disable	12-40
Set Length(s) for Code 93	4 to 55	12-41
Code 11		
Code 11	Disable	12-43
Set Lengths for Code 11	4 to 55	12-44
Code 11 Check Digit Verification	Disable	12-46
Transmit Code 11 Check Digit(s)	Disable	12-47
Interleaved 2 of 5 (ITF)		
Interleaved 2 of 5 (ITF)	Enable	12-48
Set Lengths for I 2 of 5	14	12-49
I 2 of 5 Check Digit Verification	Disable	12-51
Transmit I 2 of 5 Check Digit	Disable	12-52
Convert I 2 of 5 to EAN 13	Disable	12-53
Discrete 2 of 5 (DTF)		
Discrete 2 of 5	Disable	12-54
Set Length(s) for D 2 of 5	12	12-55
Chinese 2 of 5		
Enable/Disable Chinese 2 of 5	Disable	12-57

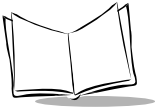

Table 12-1. Symbology Default Table (Continued)

Parameter	Default	Page Number
Codabar (NW - 7)		
Codabar	Disable	12-58
Set Lengths for Codabar	5 to 55	12-59
CLSI Editing	Disable	12-61
NOTIS Editing	Disable	12-62
MSI		
MSI	Disable	12-63
Set Length(s) for MSI	1 to 55	12-64
MSI Check Digits	One	12-66
Transmit MSI Check Digit	Disable	12-67
MSI Check Digit Algorithm	Mod 10/Mod 10	12-68
RSS (Reduced Space Symbology)		
RSS 14	Disable	12-69
RSS Limited	Disable	12-69
RSS Expanded	Disable	12-69
Convert RSS to UPC/EAN	Disable	12-71
Symbology - Specific Security Levels		
Redundancy Level	1	12-72

UPC/EAN

Enable/Disable UPC-A/UPC-E

To enable or disable UPC-A or UPC-E, scan the appropriate bar code below.

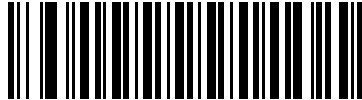

***Enable UPC-A**

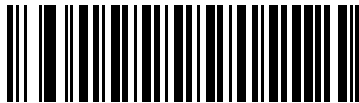

Disable UPC-A

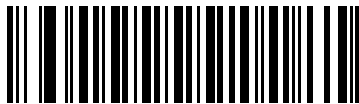

***Enable UPC-E**



Disable UPC-E

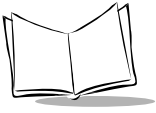

Enable/Disable UPC-E1

UPC-E1 is disabled by default.

To enable or disable UPC-E1, scan the appropriate bar code below.

Note: *UPC-E1 is not a UCC (Uniform Code Council) approved symbology.*

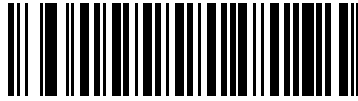

Enable UPC-E1

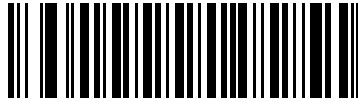

***Disable UPC-E1**

Enable/Disable EAN-13/EAN-8

To enable or disable EAN-13 or EAN-8, scan the appropriate bar code below.

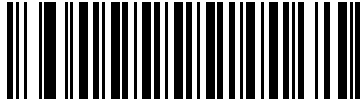

***Enable EAN-13**

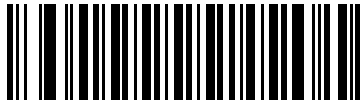

Disable EAN-13

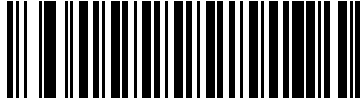

***Enable EAN-8**

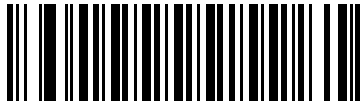

Disable EAN-8

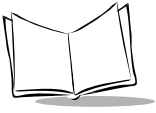

Enable/Disable Bookland EAN

To enable or disable Bookland EAN, scan the appropriate bar code below.

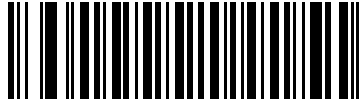

Enable Bookland EAN

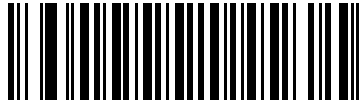

***Disable Bookland EAN**

Decode UPC/EAN/JAN Supplementals

Supplementals are bar codes appended according to specific format conventions (e.g., UPC A+2, UPC E+2, EAN 13+2). Six options are available.

- If **Decode UPC/EAN Only With Supplementals** is selected, UPC/EAN symbols without supplementals are not decoded.
- If **Ignore Supplementals** is selected, and the scanner is presented with a UPC/EAN with a supplemental, the UPC/EAN is decoded and the supplemental bar code is ignored.
- An **Autodiscriminate Option** is also available. If this option is selected, choose an appropriate *UPC/EAN/JAN Supplemental Redundancy* value from the next page. A value of 5 or more is recommended.
- **Enable 378/379 Supplemental Mode** to enable only EAN13 bar codes starting with a '378' or '379' prefix to be delayed by the supplemental search process. All other UPC/EAN bar codes are exempted from the search and are reported instantly upon their decode.
- Select **Enable 978 Supplemental Mode** to enable only EAN13 bar codes starting with a '978' prefix to be delayed by the supplemental search process. All other UPC/EAN bar codes are exempted from the search and are reported instantly upon their decode.
- Select **Enable Smart Supplemental Mode** to enable only EAN13 bar codes starting with a '378', '379', or '978' prefix to be delayed by the supplemental search process. All other UPC/EAN bar codes are exempted from the search and are reported instantly upon their decode.

Note: *In order to minimize the risk of invalid data transmission, it is recommended that you select either to decode or ignore supplemental characters.*

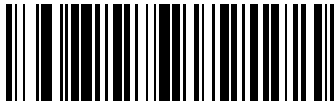

Decode UPC/EAN/JAN Only With Supplementals

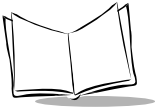

Decode UPC/EAN/JAN Supplementals (Continued)



***Ignore Supplementals**



Autodiscriminate UPC/EAN/JAN Supplementals



Enable 378/379 Supplemental Mode



Enable 978 Supplemental Mode



Enable Smart Supplemental Mode

UPC/EAN/JAN Supplemental Redundancy

With **Autodiscriminate UPC/EAN/JAN Supplementals** selected, this option adjusts the number of times a symbol without supplementals is decoded before transmission. The range is from two to thirty times. Five or above is recommended when decoding a mix of UPC/EAN symbols with and without supplementals, and the autodiscriminate option is selected. The default is set at 7.

Scan the bar code below to set a decode redundancy value. Next, scan two numeric bar codes beginning on page D-1 in Appendix D. Single digit numbers must have a leading zero. If you make an error, or wish to change your selection, scan **Cancel** on page D-5.

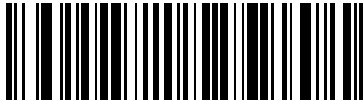

UPC/EAN/JAN Supplemental Redundancy

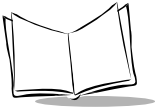

Transmit UPC-A/UPC-E/UPC-E1 Check Digit

The check digit is the last character of the symbol used to verify the integrity of the data. Scan the appropriate bar code below to transmit the bar code data with or without the UPC-A, UPC-E or UPC-E1 check digit. It is always verified to guarantee the integrity of the data.

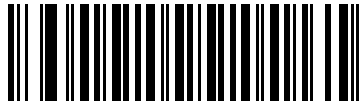

***Transmit UPC-A Check Digit**

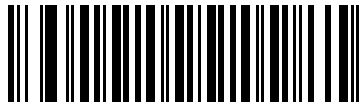

Do Not Transmit UPC-A Check Digit

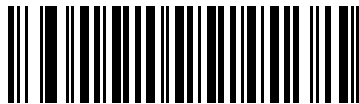

***Transmit UPC-E Check Digit**

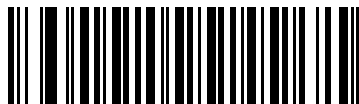

Do Not Transmit UPC-E Check Digit

Transmit UPC-A/UPC-E/UPC-E1 Check Digit (continued)



***Transmit UPC-E1 Check Digit**

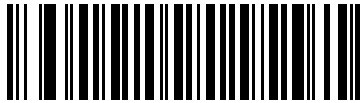

Do Not Transmit UPC-E1 Check Digit

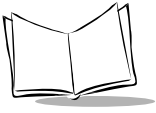

UPC-A Preamble

Preamble characters are part of the UPC symbol consisting of Country Code and System Character. Three options are given for transmitting UPC-A preamble to the host device: transmit System Character only, transmit System Character and Country Code ("0" for USA), and no preamble transmitted. Select the appropriate option to match your host system.

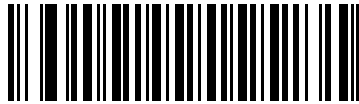

No Preamble
(<DATA>)

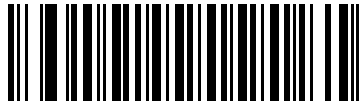

***System Character**
(<SYSTEM CHARACTER> <DATA>)

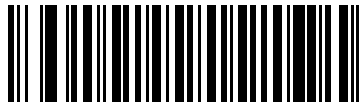

System Character & Country Code
(< COUNTRY CODE> <SYSTEM CHARACTER> <DATA>)

UPC-E Preamble

Preamble characters are part of the UPC symbol consisting of Country Code and System Character. Three options are given for transmitting UPC-E preamble to the host device: transmit System Character only, transmit System Character and Country Code ("0" for USA), and no preamble transmitted. Select the appropriate option to match your host system.

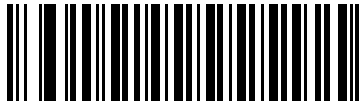

**No Preamble
(<DATA>)**

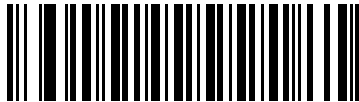

***System Character
(<SYSTEM CHARACTER> <DATA>)**

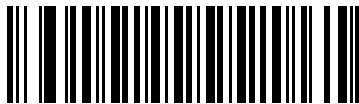

**System Character & Country Code
(< COUNTRY CODE> <SYSTEM CHARACTER> <DATA>)**

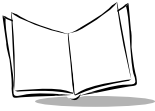

UPC-E1 Preamble

Preamble characters are part of the UPC symbol consisting of Country Code and System Character. Three options are given for transmitting UPC-E1 preamble to the host device: transmit System Character only, transmit System Character and Country Code ("0" for USA), and no preamble transmitted. Select the appropriate option to match your host system.

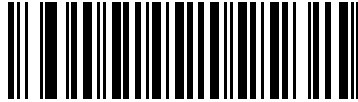

No Preamble
(<DATA>)

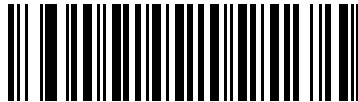

***System Character**
(<SYSTEM CHARACTER> <DATA>)



System Character & Country Code
(< COUNTRY CODE> <SYSTEM CHARACTER> <DATA>)

Convert UPC-E to UPC-A

When enabled, UPC-E (zero suppressed) decoded data is converted to UPC-A format before transmission. After conversion, the data follows UPC-A format and is affected by UPC-A programming selections (e.g., Preamble, Check Digit).

When disabled, UPC-E decoded data is transmitted as UPC-E data, without conversion.

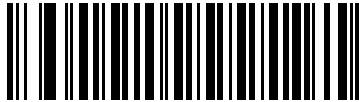

**Convert UPC-E to UPC-A
(Enable)**



***Do Not Convert UPC-E to UPC-A
(Disable)**

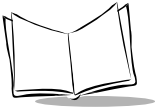

Convert UPC-E1 to UPC-A

When enabled, UPC-E1 decoded data is converted to UPC-A format before transmission. After conversion, the data follows UPC-A format and is affected by UPC-A programming selections (e.g., Preamble, Check Digit).

When disabled, UPC-E1 decoded data is transmitted as UPC-E1 data, without conversion.

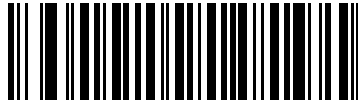

**Convert UPC-E1 to UPC-A
(Enable)**

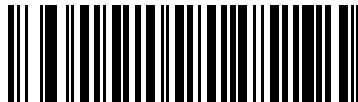

***Do Not Convert UPC-E1 to UPC-A
(Disable)**

EAN-8/JAN-8 Extend

When enabled, this parameter adds five leading zeros to decoded EAN-8 symbols to make them compatible in format to EAN-13 symbols.

When disabled, EAN-8 symbols are transmitted as is.

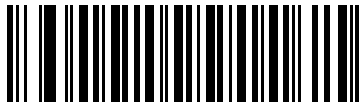

Enable EAN/JAN Zero Extend

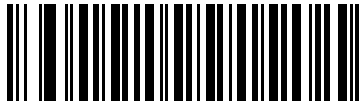

***Disable EAN/JAN Zero Extend**

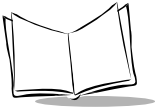

UPC/EAN Security Level

The scanner offers four levels of decode security for UPC/EAN bar codes. Increasing levels of security are provided for decreasing levels of bar code quality. There is an inverse relationship between security and scanner decode speed, so be sure to choose only that level of security necessary for any given application.

UPC/EAN Security Level 0

This is the default setting which allows the scanner to operate fastest, while providing sufficient security in decoding “in-spec” UPC/EAN bar codes.

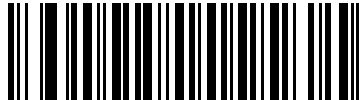

***UPC/EAN Security Level 0**

UPC/EAN Security Level 1

As bar code quality levels diminish, certain characters become prone to misdecodes before others (i.e., 1, 2, 7, 8). If you are experiencing misdecodes of poorly printed bar codes, and the misdecodes are limited to these characters, select this security level.

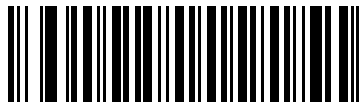

UPC/EAN Security Level 1

UPC/EAN Security Level 2

If you are experiencing misdecodes of poorly printed bar codes, and the misdecodes are not limited to characters 1, 2, 7, and 8, select this security level.

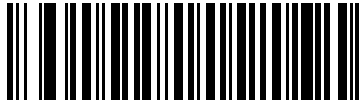

UPC/EAN Security Level 2

UPC/EAN Security Level 3

If you have tried Security Level 2, and are still experiencing misdecodes, select this security level. Be advised, selecting this option is an extreme measure against misdecoding severely out of spec bar codes. Selection of this level of security may significantly impair the decoding ability of the scanner. If this level of security is necessary, you should try to improve the quality of your bar codes.

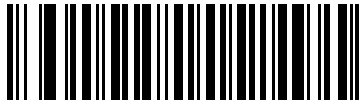

UPC/EAN Security Level 3

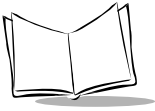

UCC Coupon Extended Code

When enabled, this parameter decodes UPCA barcodes starting with digit '5', EAN-13 barcodes starting with digit '99', and UPCA/EAN-128 Coupon Codes. UPCA, EAN-13 and EAN-128 must be enabled to scan all types of Coupon Codes.



Enable UCC Coupon Extended Code

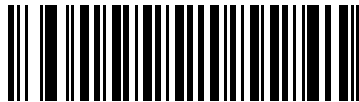

***Disable UCC Coupon Extended Code**

Note: *Autodiscrimination of the EAN128 (right half) of a coupon code is controlled by the Decode UPC/EAN Supplemental Redundancy parameter.*

Code 128

Enable/Disable Code 128

To enable or disable Code 128, scan the appropriate bar code below.

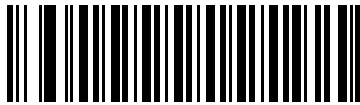

***Enable Code 128**

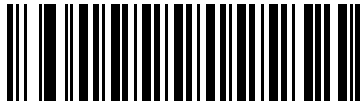

Disable Code 128

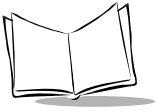

Enable/Disable UCC/EAN-128

To enable or disable UCC/EAN-128, scan the appropriate bar code below.

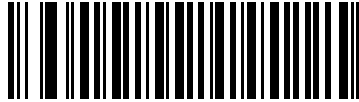

***Enable UCC/EAN-128**

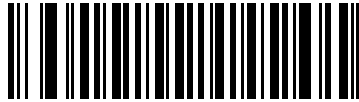

Disable UCC/EAN-128

Code 39

Enable/Disable Code 39

To enable or disable Code 39, scan the appropriate bar code below.

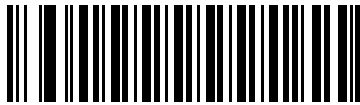

***Enable Code 39**



Disable Code 39

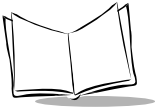

Enable/Disable Trioptic Code 39

Trioptic Code 39 is a variant of Code 39 used in the marking of computer tape cartridges. Trioptic Code 39 symbols always contain six characters. To enable or disable Trioptic Code 39, scan the appropriate bar code below.



Enable Trioptic Code 39

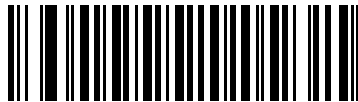

***Disable Trioptic Code 39**

Note: *Trioptic Code 39 and Code 39 Full ASCII cannot be enabled simultaneously.*

Convert Code 39 to Code 32

Code 32 is a variant of Code 39 used by the Italian pharmaceutical industry. Scan the appropriate bar code below to enable or disable converting Code 39 to Code 32.

Note: *Code 39 must be enabled in order for this parameter to function.*

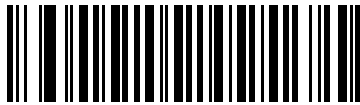

Enable Convert Code 39 to Code 32



***Disable Convert Code 39 to Code 32**

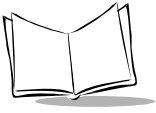

Code 32 Prefix

Scan the appropriate bar code below to enable or disable adding the prefix character “A” to all Code 32 bar codes.

Note: Convert Code 39 to Code 32 must be enabled for this parameter to function.

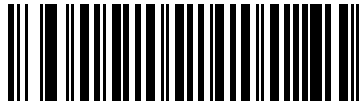

Enable Code 32 Prefix

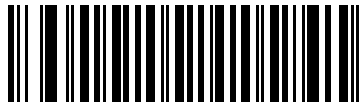

*Disable Code 32 Prefix

Set Lengths for Code 39

The length of a code refers to the number of characters (i.e., human readable characters), including check digit(s) the code contains. Lengths for Code 39 may be set for any length, one or two discrete lengths, or lengths within a specific range. If Code 39 Full ASCII is enabled, **Length Within a Range** or **Any Length** are the preferred options.

Note: *When setting lengths for different bar code types by scanning single digit numbers, single digit numbers must always be preceded by a leading zero.*

One Discrete Length - This option allows you to decode only those Code 39 symbols containing a selected length. Lengths are selected from the numeric bar codes beginning on page D-1 in Appendix D. For example, to decode only Code 39 symbols with 14 characters, scan **Code 39 - One Discrete Length**, then scan **1** followed by **4**. If you make an error or wish to change your selection, scan **Cancel** on page D-5.



Code 39 - One Discrete Length

Two Discrete Lengths - This option allows you to decode only those Code 39 symbols containing either of two selected lengths. Lengths are selected from the numeric bar codes beginning on page D-1 in Appendix D. For example, to decode only those Code 39 symbols containing either 2 or 14 characters, select **Code 39 - Two Discrete Lengths**, then scan **0, 2, 1**, and then **4**. If you make an error or wish to change your selection, scan **Cancel** on page D-5.



Code 39 - Two Discrete Lengths

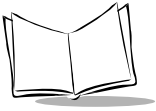

Set Lengths for Code 39 (continued)

Length Within Range - This option allows you to decode a Code 39 symbol with a specific length range. The length range is selected from numeric bar codes beginning on page D-1 in Appendix D. For example, to decode Code 39 symbols containing between 4 and 12 characters, first scan **Code 39 - Length Within Range**. Then scan **0, 4, 1, and 2** (single digit numbers must always be preceded by a leading zero). If you make an error or wish to change your selection, scan **Cancel** on page D-5.



Code 39 - Length Within Range

Any Length - Scanning this option allows you to decode Code 39 symbols containing any number of characters within the scanner capability.



Code 39 - Any Length

Code 39 Check Digit Verification

When this feature is enabled, the scanner checks the integrity of all Code 39 symbols to verify that the data complies with specified check digit algorithm. Only those Code 39 symbols which include a modulo 43 check digit are decoded when this feature is enabled. This feature should only be enabled if your code 39 symbols contain a Modulo 43 check digit.

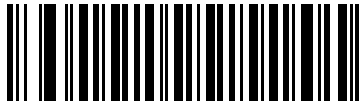

Enable Code 39 Check Digit

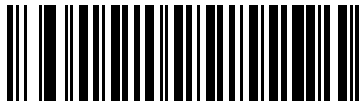

***Disable Code 39 Check Digit**

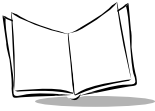

Transmit Code 39 Check Digit

Scan a bar code below to transmit Code 39 data with or without the check digit.

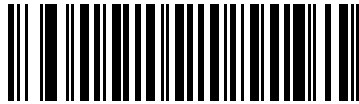

**Transmit Code 39 Check Digit
(Enable)**

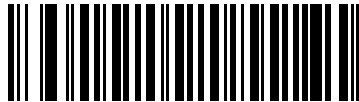

***Do Not Transmit Code 39 Check Digit
(Disable)**

Note: *Code 39 Check Digit Verification must be enabled for this parameter to function.*

Code 39 Full ASCII Conversion

Code 39 Full ASCII is a variant of Code 39 which pairs characters to encode the full ASCII character set. To enable or disable Code 39 Full ASCII, scan the appropriate bar code below.

Refer to Table 5-2 on page 5-18 and for the mapping of Code 39 characters to ASCII values.

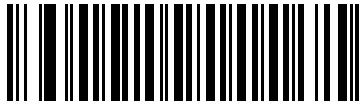

Enable Code 39 Full ASCII

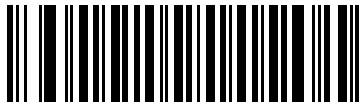

***Disable Code 39 Full ASCII**

Note: *Trioptic Code 39 and Code 39 Full ASCII cannot be enabled simultaneously.*

Note: *Code 39 Full ASCII to Full ASCII Correlation is host-dependent, and is therefore described in the "ASCII Character Set" Table for the appropriate interface. The Wedge Host conversion table can be found on 5-3, USB Host conversion table can be found on 7-4, and RS-232 Host conversion table can be found on 6-3.*

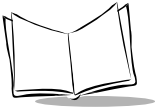

Code 39 Buffering (Scan & Store)

This feature allows the scanner to accumulate data from multiple Code 39 symbols.

When you select the Scan and Store option (Buffer Code 39), all Code 39 symbols having a leading space as a first character are temporarily buffered in the unit to be transmitted later. The leading space is not buffered.

Decode of a valid Code 39 symbol with no leading space causes transmission in sequence of all buffered data in a first-in first-out format, plus transmission of the “triggering” symbol. See the following pages for further details.

When the **Do Not Buffer Code 39** option is selected, all decoded Code 39 symbols are transmitted immediately without being stored in the buffer.

This feature affects Code 39 only. If you select **Buffer Code 39**, we recommend that you configure the scanner to decode Code 39 symbology only.

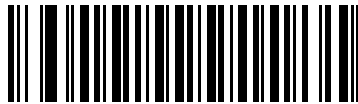

**Buffer Code 39
(Enable)**

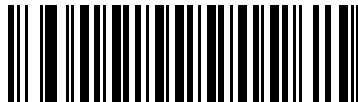

***Do Not Buffer Code 39
(Disable)**

While there is data in the transmission buffer, selecting **Do Not Buffer Code 39** is not allowed. The buffer holds 200 bytes of information.

To disable Code 39 buffering when there is data in the transmission buffer, first force the buffer transmission (see *Transmit Buffer* on page 12-38) or clear the buffer.

Buffer Data

To buffer data, Code 39 buffering must be enabled and a Code 39 symbol must be read with a space immediately following the start pattern.

- Unless the data overflows the transmission buffer, the scanner issues a lo/hi beep to indicate successful decode and buffering. (For overflow conditions, see *Overfilling Transmission Buffer*.)
- The scanner adds the decoded data excluding the leading space to the transmission buffer.
- No transmission occurs.

Clear Transmission Buffer

To clear the transmission buffer, scan the **Clear Buffer** bar code below, which contains only a start character, a dash (minus), and a stop character.

- The scanner issues a short hi/lo/hi beep.
- The scanner erases the transmission buffer.
- No transmission occurs.



Clear Buffer

Note: *The Clear Buffer contains only the dash (minus) character. In order to scan this command, be sure Code 39 length is set to include length 1.*

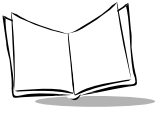

Transmit Buffer

There are two methods to transmit the Code 39 buffer.

1. Scan the **Transmit Buffer** bar code below. Only a start character, a plus (+), and a stop character.
 - The scanner transmits and clears the buffer.
 - The scanner issues a Lo/Hi beep.



Transmit Buffer

2. Scan a Code 39 bar code with a leading character other than a space.
 - The scanner appends new decode data to buffered data.
 - The scanner transmits and clears the buffer.
 - The scanner signals that the buffer was transmitted with a lo/hi beep.
 - Scanner transmits and clears the buffer.

Note: *The Transmit Buffer contains only a plus (+) character. In order to scan this command, be sure Code 39 length is set to include length 1.*

Overfilling Transmission Buffer

The Code 39 buffer holds 200 characters. If the symbol just read results in an overflow of the transmission buffer:

- The scanner indicates that the symbol was rejected by issuing three long, high beeps.
- No transmission occurs. The data in the buffer is not affected.

Attempt to Transmit an Empty Buffer

If the symbol just read was the **Transmit Buffer** symbol and the Code 39 buffer is empty:

- A short lo/hi/lo beep signals that the buffer is empty.
- No transmission occurs.
- The buffer remains empty.

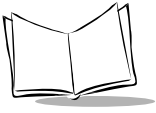

Code 93

Enable/Disable Code 93

To enable or disable Code 93, scan the appropriate bar code below.

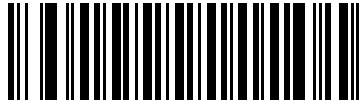

Enable Code 93

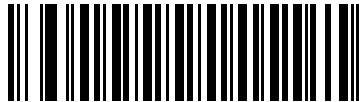

***Disable Code 93**

Set Lengths for Code 93

The length of a code refers to the number of characters (i.e., human readable characters), including check digit(s) the code contains. Lengths for Code 93 may be set for any length, one or two discrete lengths, or lengths within a specific range.

One Discrete Length - This option allows you to decode only those Code 93 symbols containing a selected length. Lengths are selected from the numeric bar codes beginning on page D-1 in Appendix D. For example, to decode only Code 93 symbols with 14 characters, scan **Code 93 - One Discrete Length**, then scan **1** followed by **4**. If you make an error or wish to change your selection, scan **Cancel** on page D-5.



Code 93 - One Discrete Length

Two Discrete Lengths - This option allows you to decode only those Code 93 symbols containing either of two selected lengths. Lengths are selected from the numeric bar codes beginning on page D-1 in Appendix D. For example, to decode only those Code 93 symbols containing either 2 or 14 characters, select **Code 93 - Two Discrete Lengths**, then scan **0**, **2**, **1**, and then **4**. If you make an error or wish to change your selection, scan **Cancel** on page D-5.



Code 93 - Two Discrete Lengths

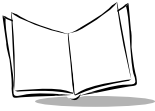

Set Lengths for Code 93 (continued)

Length Within Range - This option allows you to decode a Code 93 symbol with a specific length range. The length range is selected from numeric bar codes beginning on page D-1 in Appendix D. For example, to decode Code 93 symbols containing between 4 and 12 characters, first scan **Code 93 - Length Within Range**. Then scan **0, 4, 1, and 2** (single digit numbers must always be preceded by a leading zero). If you make an error or wish to change your selection, scan **Cancel** on page D-5.



Code 93 - Length Within Range

Any Length - Scanning this option allows you to decode Code 93 symbols containing any number of characters within the scanner's capability.



Code 93 - Any Length

Code 11

Code 11

To enable or disable Code 11, scan the appropriate bar code below.

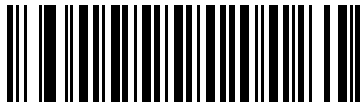

Enable Code 11

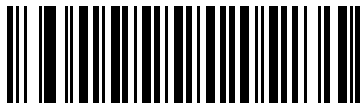

***Disable Code 11**

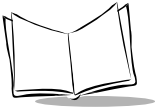

Set Lengths for Code 11

The length of a code refers to the number of characters (i.e., human readable characters), including check digit(s) the code contains. Lengths for Code 11 may be set for any length, one or two discrete lengths, or lengths within a specific range.

One Discrete Length - This option allows you to decode only those Code 11 symbols containing a selected length. Lengths are selected from the numeric bar codes beginning on page D-1 in Appendix D. For example, to decode only Code 11 symbols with 14 characters, scan **Code 11 - One Discrete Length**, then scan **1** followed by **4**. If you make an error or wish to change your selection, scan **Cancel** on page D-5.

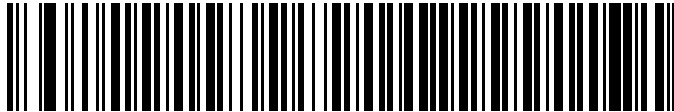

Code 11 - One Discrete Length

Two Discrete Lengths - This option allows you to decode only those Code 11 symbols containing either of two selected lengths. Lengths are selected from the numeric bar codes beginning on page D-1 in Appendix D. For example, to decode only those Code 11 symbols containing either 2 or 14 characters, select **Code 11 - Two Discrete Lengths**, then scan **0**, **2**, **1**, and then **4**. If you make an error or wish to change your selection, scan **Cancel** on page D-5.

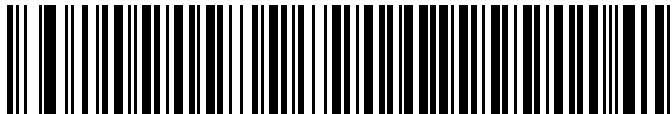

Code 11 - Two Discrete Lengths

Set Lengths for Code 11 (continued)

Length Within Range - This option allows you to decode a Code 11 symbol with a specific length range. The length range is selected from numeric bar codes beginning on page D-1 in Appendix D. For example, to decode Code 11 symbols containing between 4 and 12 characters, first scan **Code 11 - Length Within Range**. Then scan **0, 4, 1, and 2** (single digit numbers must always be preceded by a leading zero). If you make an error or wish to change your selection, scan **Cancel** on page D-5.



Code 11 - Length Within Range

Any Length - Scanning this option allows you to decode Code 11 symbols containing any number of characters within the scanner capability.



Code 11 - Any Length

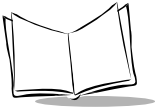

Code 11 Check Digit Verification

This feature allows the scanner to check the integrity of all Code 11 symbols to verify that the data complies with the specified check digit algorithm. This selects the check digit mechanism for the decoded Code 11 bar code. The options are to check for one check digit, check for two check digits, or disable the feature.

To enable this feature, scan the bar code below corresponding to the number of check digits encoded in your Code 11 symbols.



***Disable**

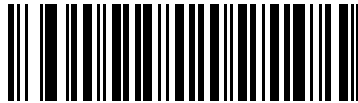

One Check Digit

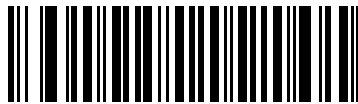

Two Check Digits

Transmit Code 11 Check Digits

This feature selects whether or not to transmit the Code 11 check digit(s).

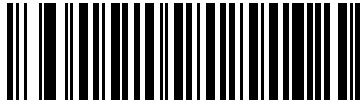

**Transmit Code 11 Check Digit(s)
(Enable)**

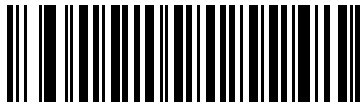

***Do Not Transmit Code 11 Check Digit(s)
(Disable)**

Note: *Code 11 Check Digit Verification must be enabled for this parameter to function.*

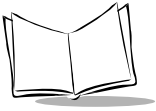

Interleaved 2 of 5 (ITF)

Enable/Disable Interleaved 2 of 5

To enable or disable Interleaved 2 of 5, scan the appropriate bar code below, and select an Interleaved 2 of 5 length from the following pages.

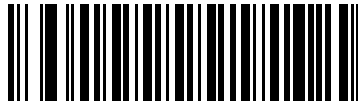

***Enable Interleaved 2 of 5**

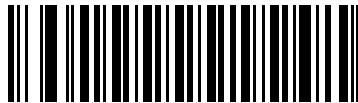

Disable Interleaved 2 of 5

Set Lengths for Interleaved 2 of 5

The length of a code refers to the number of characters (i.e., human readable characters), including check digit(s) the code contains. Lengths for I 2 of 5 may be set for any length, one or two discrete lengths, or lengths within a specific range.

One Discrete Length - This option allows you to decode only those I 2 of 5 symbols containing a selected length. Lengths are selected from the numeric bar codes beginning on page D-1 in Appendix D. For example, to decode only I 2 of 5 symbols with 14 characters, scan **I 2 of 5 - One Discrete Length**, then scan **1** followed by **4**. If you make an error or wish to change your selection, scan **Cancel** on page D-5.

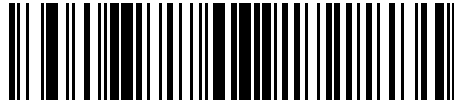

I 2 of 5 - One Discrete Length

Two Discrete Lengths - This option allows you to decode only those I 2 of 5 symbols containing either of two selected lengths. Lengths are selected from the numeric bar codes beginning on page D-1 in Appendix D. For example, to decode only those I 2 of 5 symbols containing either 2 or 14 characters, select **I 2 of 5 - Two Discrete Lengths**, then scan **0**, **2**, **1**, and then **4**. If you make an error or wish to change your selection, scan **Cancel** on page D-5.

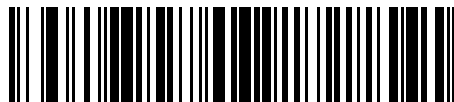

I 2 of 5 - Two Discrete Lengths

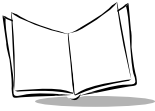

Set Lengths for Interleaved 2 of 5 (continued)

Length Within Range - This option allows you to decode an I 2 of 5 symbol with a specific length range. The length range is selected from numeric bar codes beginning on page D-1 in Appendix D. For example, to decode I 2 of 5 symbols containing between 4 and 12 characters, first scan **I 2 of 5 - Length Within Range**. Then scan **0, 4, 1, and 2** (single digit numbers must always be preceded by a leading zero). If you make an error or wish to change your selection, scan **Cancel** on page D-5.

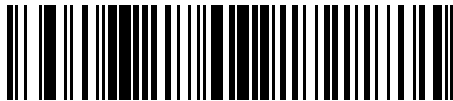

I 2 of 5 - Length Within Range

Any Length - Scanning this option allows you to decode I 2 of 5 symbols containing any number of characters within the scanner capability.

Note: *Due to the construction of the I 2 of 5 symbology, it is possible for a scan line covering only a portion of the code to be interpreted as a complete scan, yielding less data than is actually encoded in the bar code. To prevent this from happening, it is recommended that specific lengths (**I 2 of 5 - One Discrete Length - Two Discrete Lengths**) be selected for I 2 of 5 applications.*



I 2 of 5 - Any Length

1 2 of 5 Check Digit Verification

When this feature is enabled, the scanner checks the integrity of all 1 2 of 5 symbols to verify the data complies with either the specified Uniform Symbology Specification (USS), or the Optical Product Code Council (OPCC) check digit algorithm.



*** Disable**



USS Check Digit



OPCC Check Digit

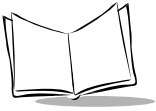

Transmit I 2 of 5 Check Digit

Scan the appropriate bar code below to transmit I 2 of 5 data with or without the check digit.



**Transmit I 2 of 5 Check Digit
(Enable)**

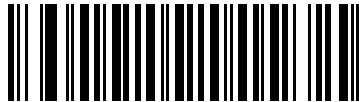

***Do Not Transmit I 2 of 5 Check Digit
(Disable)**

Convert I 2 of 5 to EAN-13

This parameter converts a 14 character I 2 of 5 code into EAN-13, and transmits to the host as EAN-13. In order to accomplish this, the I 2 of 5 code must be enabled, and the code must have a leading zero and a valid EAN-13 check digit.

Scanning a single bar code below, **Convert I 2 of 5 to EAN-13 (Enable)**, accomplishes this function.

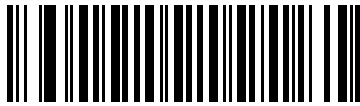

**Convert I 2 of 5 to EAN-13
(Enable)**



***Do Not Convert I 2 of 5 to EAN-13
(Disable)**

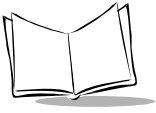

Discrete 2 of 5 (DTF)

Enable/Disable Discrete 2 of 5

To enable or disable Discrete 2 of 5, scan the appropriate bar code below.

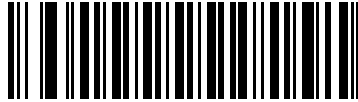

Enable Discrete 2 of 5

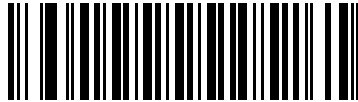

***Disable Discrete 2 of 5**

Set Lengths for Discrete 2 of 5

The length of a code refers to the number of characters (i.e., human readable characters), including check digit(s) the code contains. Lengths for D 2 of 5 may be set for any length, one or two discrete lengths, or lengths within a specific range.

One Discrete Length - This option allows you to decode only those D 2 of 5 symbols containing a selected length. Lengths are selected from the numeric bar codes beginning on page D-1 in Appendix D. For example, to decode only D 2 of 5 symbols with 14 characters, scan **D 2 of 5 - One Discrete Length**, then scan **1** followed by **4**. If you make an error or wish to change your selection, scan **Cancel** on page D-5.



D 2 of 5 - One Discrete Length

Two Discrete Lengths - This option allows you to decode only those D 2 of 5 symbols containing either of two selected lengths. Lengths are selected from the numeric bar codes beginning on page D-1 in Appendix D. For example, to decode only those D 2 of 5 symbols containing either 2 or 14 characters, select **D 2 of 5 - Two Discrete Lengths**, then scan **0**, **2**, **1**, and then **4**. If you make an error or wish to change your selection, scan **Cancel** on page D-5.



D 2 of 5 - Two Discrete Lengths

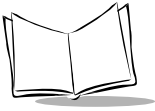

Set Lengths for Discrete 2 of 5 (continued)

Length Within Range - This option allows you to decode an D 2 of 5 symbol with a specific length range. The length range is selected from numeric bar codes beginning on page D-1 in Appendix D. For example, to decode D 2 of 5 symbols containing between 4 and 12 characters, first scan **D 2 of 5 - Length Within Range**. Then scan **0, 4, 1, and 2** (single digit numbers must always be preceded by a leading zero). If you make an error or wish to change your selection, scan **Cancel** on page D-5.



D 2 of 5 - Length Within Range

Any Length - Scanning this option allows you to decode D 2 of 5 symbols containing any number of characters within the scanner capability.

Note: *Due to the construction of the D 2 of 5 symbology, it is possible for a scan line covering only a portion of the code to be interpreted as a complete scan, yielding less data than is actually encoded in the bar code. To prevent this from happening, it is recommended that specific lengths (**D 2 of 5 - One Discrete Length - Two Discrete Lengths**) be selected for D 2 of 5 applications.*



D 2 of 5 - Any Length

Chinese 2 of 5

Enable/Disable Chinese 2 of 5

To enable or disable Chinese 2 of 5, scan the appropriate bar code below.



Enable Chinese 2 of 5



***Disable Chinese 2 of 5**

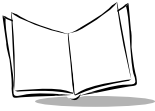

Codabar (NW - 7)

Enable/Disable Codabar

To enable or disable Codabar, scan the appropriate bar code below.



Enable Codabar

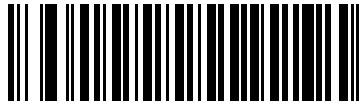

***Disable Codabar**

Set Lengths for Codabar

The length of a code refers to the number of characters (i.e., human readable characters), including check digit(s) the code contains. Lengths for Codabar may be set for any length, one or two discrete lengths, or lengths within a specific range.

One Discrete Length - This option allows you to decode only those Codabar symbols containing a selected length. Lengths are selected from the numeric bar codes beginning on page D-1 in Appendix D. For example, to decode only Codabar symbols with 14 characters, scan **Codabar - One Discrete Length**, then scan **1** followed by **4**. If you make an error or wish to change your selection, scan **Cancel** on page D-5.



Codabar - One Discrete Length

Two Discrete Lengths - This option allows you to decode only those Codabar symbols containing either of two selected lengths. Lengths are selected from the numeric bar codes beginning on page D-1 in Appendix D. For example, to decode only those Codabar symbols containing either 2 or 14 characters, select **Codabar - Two Discrete Lengths**, then scan **0**, **2**, **1**, and then **4**. If you make an error or wish to change your selection, scan **Cancel** on page D-5.



Codabar - Two Discrete Lengths

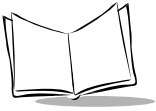

Set Lengths for Codabar (continued)

Length Within Range - This option allows you to decode a Codabar symbol with a specific length range. The length range is selected from numeric bar codes beginning on page D-1 in Appendix D. For example, to decode Codabar symbols containing between 4 and 12 characters, first scan **Codabar - Length Within Range**. Then scan **0, 4, 1, and 2** (single digit numbers must always be preceded by a leading zero). If you make an error or wish to change your selection, scan **Cancel** on page D-5.



Codabar - Length Within Range

Any Length - Scanning this option allows you to decode Codabar symbols containing any number of characters within the scanner capability.



Codabar - Any Length

CLSI Editing

When enabled, this parameter strips the start and stop characters and inserts a space after the first, fifth, and tenth characters of a 14-character Codabar symbol. Enable this feature if your host system requires this data format.

Note: *Symbol length does not include start and stop characters.*

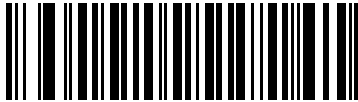

Enable CLSI Editing

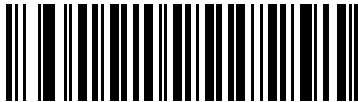

***Disable CLSI Editing**

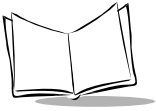

NOTIS Editing

When enabled, this parameter strips the start and stop characters from a decoded Codabar symbol. Enable this feature if your host system requires this data format.

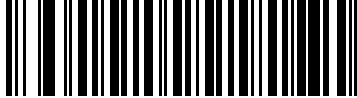

Enable NOTIS Editing

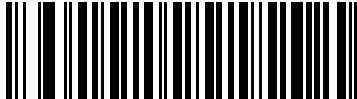

***Disable NOTIS Editing**

MSI

Enable/Disable MSI

To enable or disable MSI, scan the appropriate bar code below.

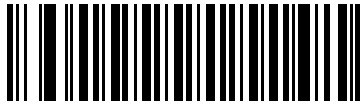

Enable MSI

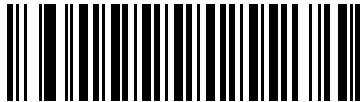

***Disable MSI**

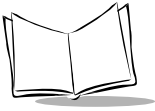

Set Lengths for MSI

The length of a code refers to the number of characters (i.e., human readable characters), including check digit(s) the code contains. Lengths for MSI may be set for any length, one or two discrete lengths, or lengths within a specific range.

One Discrete Length - This option allows you to decode only those MSI symbols containing a selected length. Lengths are selected from the numeric bar codes beginning on page D-1 in Appendix D. For example, to decode only MSI symbols with 14 characters, scan **MSI - One Discrete Length**, then scan **1** followed by **4**. If you make an error or wish to change your selection, scan **Cancel** on page D-5.



MSI - One Discrete Length

Two Discrete Lengths - This option allows you to decode only those MSI symbols containing either of two selected lengths. Lengths are selected from the numeric bar codes beginning on page D-1 in Appendix D. For example, to decode only those MSI symbols containing either 2 or 14 characters, select **MSI - Two Discrete Lengths**, then scan **0**, **2**, **1**, and then **4**. If you make an error or wish to change your selection, scan **Cancel** on page D-5.



MSI - Two Discrete Lengths

Set Lengths for MSI (continued)

Length Within Range - This option allows you to decode an MSI symbol with a specific length range. The length range is selected from numeric bar codes beginning on page D-1 in Appendix D. For example, to decode MSI symbols containing between 4 and 12 characters, first scan **MSI - Length Within Range**. Then scan **0, 4, 1, and 2** (single digit numbers must always be preceded by a leading zero). If you make an error or wish to change your selection, scan **Cancel** on page D-5.



MSI - Length Within Range

Any Length - Scanning this option allows you to decode MSI symbols containing any number of characters within the scanner capability.

Note: *Due to the construction of the MSI symbology, it is possible for a scan line covering only a portion of the code to be interpreted as a complete scan, yielding less data than is actually encoded in the bar code. To prevent this from happening, it is recommended that specific lengths (**MSI - One Discrete Length - Two Discrete Lengths**) be selected for MSI applications.*



MSI - Any Length

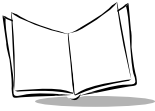

MSI Check Digits

With MSI symbols, one check digit is mandatory and always verified by the reader. The second check digit is optional. If your MSI codes include two check digits, enable the verification of the second check digit by scanning the barcode below.

Refer to *MSI Check Digit Algorithm* on page 12-68 for the selection of second digit algorithms.

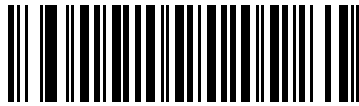

***One MSI Check Digit**

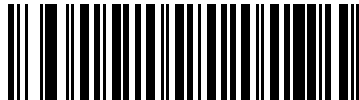

Two MSI Check Digits

Transmit MSI Check Digit(s)

Scan a bar code below to transmit MSI data with or without the check digit.

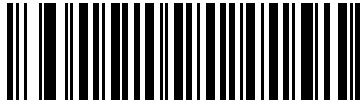

**Transmit MSI Check Digit(s)
(Enable)**

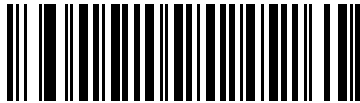

***Do Not Transmit MSI Check Digit(s)
(Disable)**

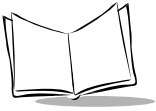

MSI Check Digit Algorithm

Two algorithms are possible for the verification of the second MSI check digit. Select the bar code below corresponding to the algorithm used to encode your check digit.

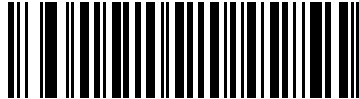

MOD 10/MOD 11

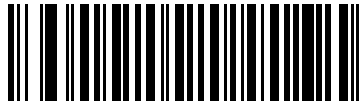

***MOD 10/MOD 10**

RSS (Reduced Space Symbology)

RSS

The variants of RSS are RSS 14, RSS Expanded, and RSS Limited. The limited and expanded versions have stacked variants. Scan the appropriate bar code below to enable or disable each variant of RSS.

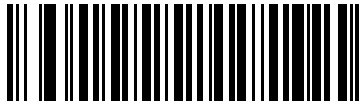

Enable RSS 14

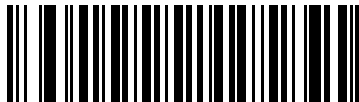

***Disable RSS 14**

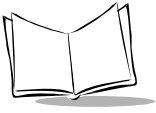

RSS (continued)



Enable RSS Limited

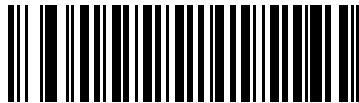

***Disable RSS Limited**

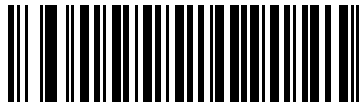

Enable RSS Expanded

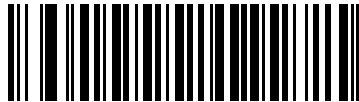

***Disable RSS Expanded**

Convert RSS to UPC/EAN

This parameter only applies to RSS-14 and RSS Limited symbols not decoded as part of a Composite symbol. When this conversion is enabled, RSS-14 and RSS Limited symbols encoding a single zero as the first digit have the leading '010' stripped and the bar code reported as EAN-13.

Bar codes beginning with two or more zeros but not six zeros have the leading '0100' stripped and the bar code reported as UPC-A. The UPC-A Preamble parameter to transmit the system character and country code applies to converted bar codes. Note that neither the system character nor the check digit can be stripped.

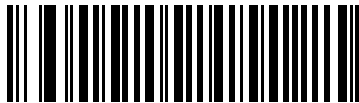

Enable

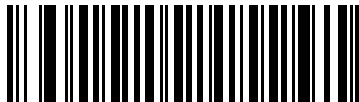

***Disable**

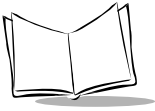

Redundancy Level

The LS 2208 offers four levels of decode redundancy. Higher redundancy levels are selected for decreasing levels of bar code quality. As redundancy levels increase, the scanner's aggressiveness decreases.

Select the redundancy level appropriate for the bar code quality.

Redundancy Level 1

The following code types must be successfully read twice before being decoded:

Code Type	Code Length
Codabar	8 characters or less
MSI	4 characters or less
D 2 of 5	8 characters or less
I 2 of 5	8 characters or less

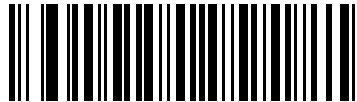

***REDUNDANCY LEVEL 1**

Redundancy Level 2

The following code types must be successfully read twice before being decoded:

Code Type	Code Length
All	All

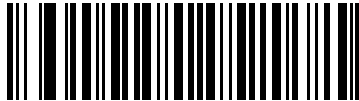

REDUNDANCY LEVEL 2

Redundancy Level 3

Code types other than the following must be successfully read twice before being decoded.
The following codes must be read three times:

Code Type	Code Length
MSI Plessey	4 characters or less
D 2 of 5	8 characters or less
I 2 of 5	8 characters or less
Codabar	8 characters or less



REDUNDANCY LEVEL 3

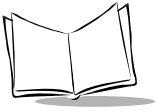

Redundancy Level 4

The following code types must be successfully read three times before being decoded:

Code Type	Code Length
All	All

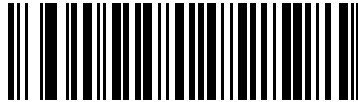

REDUNDANCY LEVEL 4

Security Level

The LS 2208 offers four levels of decode security for delta bar codes. These include the Code 128 family, UPC/EAN and Code 93. Increasing levels of security are provided for decreasing levels of bar code quality. There is an inverse relationship between security and scanner aggressiveness, so be sure to choose only that level of security necessary for any given application.

Security Level 0

This is the default setting which allows the scanner to operate in its most aggressive state, while providing sufficient security in decoding most “in-spec” bar codes.

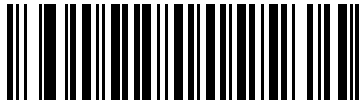

***SECURITY LEVEL 0**

Security Level 1

Select this option if misdecodes occur. This security level should eliminate most misdecodes.

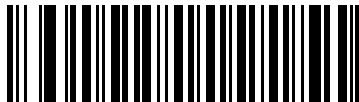

SECURITY LEVEL 1

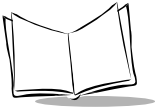

Security Level 2

Select this option if Security level 1 fails to eliminate misdecodes.

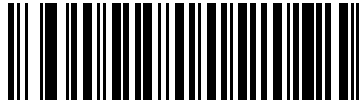

SECURITY LEVEL 2

Security Level 3

If Security Level 2 has been tried and misdecodes are still occurring, select this security level. Be advised, selecting this option is an extreme measure against mis-decoding severely out of spec bar codes. Selection of this level of security significantly impairs the decoding ability of the scanner. If this level of security is necessary, try to improve the quality of the bar codes.

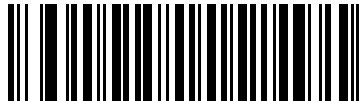

SECURITY LEVEL 3

Bi-directional Redundancy

Bi-directional Redundancy is used for added security to linear code type security levels. When enabled, a bar code must be successfully scanned in both directions (forward and reverse) before reporting a good decode.

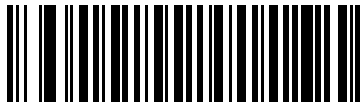

Enable Bi-directional Redundancy

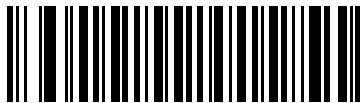

***Disable Bi-directional Redundancy**

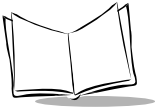

Intercharacter Gap Size

The Code 39 and Codabar symbologies have an intercharacter gap that is customarily quite small. Due to various barcode-printing technologies, this gap may grow larger than the maximum size allowed, causing the scanner to be unable to decode the symbol. If this problem is encountered, then the "Large Intercharacter Gaps" parameter should be scanned, to tolerate these out-of-specification barcodes.



***Normal Intercharacter Gaps**



Large Intercharacter Gaps



Chapter 13

Miscellaneous Scanner Options

Introduction

This chapter includes commonly used bar codes to customize how your data is transmitted to your host device. In addition to these bar codes for data formatting, refer to each host chapter for the appropriate host connections and host device features for your scanner. Refer to Chapter 12, *Symbologies* and Chapter 14, *Advanced Data Formatting* for customizing data for transmission to your host device.

Before programming, follow the instructions in Chapter 1, *Getting Started*.

Your scanner is shipped with the settings shown in the *Miscellaneous Scanner Options Default Table* on page 13-3 (also see Appendix A, *Standard Default Parameters* for all host device and miscellaneous scanner defaults). If the default values suit your requirements, programming may not be necessary. Features values are set by scanning single bar codes or short bar code sequences.

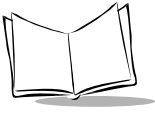

Scanning Sequence Examples

In most cases you need only scan one bar code to set a specific parameter value.

Parameters, such as **Prefix Value**, require that you scan several bar codes in the proper sequence. Refer to each individual parameter for descriptions of this procedure.

Errors While Scanning

Unless otherwise specified, if you make an error during a scanning sequence, just re-scan the correct parameter.

Miscellaneous Default Parameters

Table 13-1 lists the defaults for miscellaneous scanner options parameters. If you wish to change any option, scan the appropriate bar code(s) provided in the Miscellaneous Scanner Parameters section beginning on page 13-4.

Note: See Appendix A, Standard Default Parameters for all user preferences, hosts, symbologies, and miscellaneous default parameters.

Table 13-1. Miscellaneous Scanner Options Default Table

Parameter	Default	Page Number
Transmit Code ID Character	None	13-4
Prefix Value	7013 <CR><LF>	13-5
Suffix Value	7013 <CR><LF>	13-5
Scan Data Transmission Format	Data as is	13-6
FN1 Substitution Values	Set	13-9
Transmit "No Read" Message	Disable	13-10
Synapse Interface	Standard	13-11
Transmit Code ID Character	None	13-4

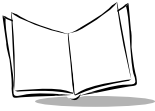

Miscellaneous Scanner Parameters

Transmit Code ID Character

A Code ID character identifies the code type of a scanned bar code. This may be useful when the scanner is decoding more than one code type. In addition to any single character prefix already selected, the Code ID character is inserted between the prefix and the decoded symbol.

The user may select no Code ID character, a Symbol Code ID character, or an AIM Code ID character. For Code ID Characters, see *Symbol Code Identifiers* on page B-1 and *AIM Code Identifiers* on page B-3.

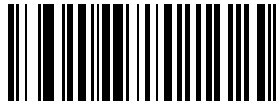

Symbol Code ID Character

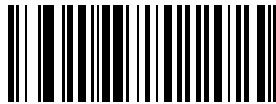

AIM Code ID Character

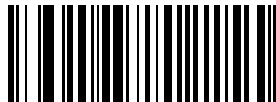

***None**

Prefix/Suffix Values

A prefix/suffix may be appended to scan data for use in data editing. These values are set by scanning a four-digit number (i.e., four bar codes) that corresponds to key codes for various terminals. See Table E-1 on page E-1 for conversion information. Numeric bar codes begin on page D-1 in Appendix D. If you make an error or wish to change your selection, scan **Cancel** on page D-5.

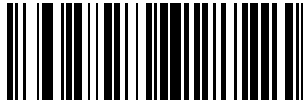

Scan Prefix



Scan Suffix

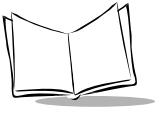

Scan Data Transmission Format

To change the Scan Data Transmission Format, scan the **Scan Options** bar code below. Then select one of four options:

- Data As Is
- <DATA> <SUFFIX>
- <PREFIX> <DATA>
- <PREFIX> <DATA> <SUFFIX>

When you have made your selection, scan the **Enter** bar code on page 13-8. If you make a mistake, scan the **Data Format Cancel** bar code on page 13-8.

If you need to have a carriage return/enter after each bar code scanned, scan the following bar codes in order:

1. <SCAN OPTIONS>
2. <DATA> <SUFFIX>
3. Enter (on page 13-8)

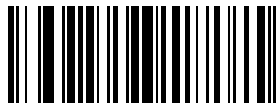

Scan Options

Scan Data Transmission Format(continued)



*Data As Is

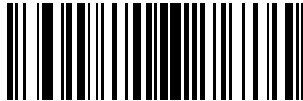

<DATA> <SUFFIX>

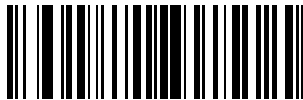

<PREFIX> <DATA>

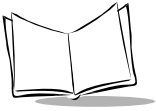

Scan Data Transmission Format (continued)



<PREFIX> <DATA> <SUFFIX>

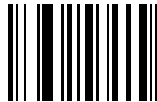

Enter



Data Format Cancel

FN1 Substitution Values

The Wedge and USB HID Keyboard hosts support a FN1 Substitution feature. When enabled any FN1 character (0x1b) in an EAN128 barcode is substituted with a value. This value defaults to 7013 (Enter Key)

1. To select a FN1 Substitution Value, scan the bar code below.

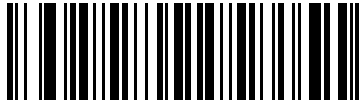

Set FN1 Substitution Value

2. Look up the keystroke desired for FN1 Substitution in the ASCII Character Set table for the currently installed host interface. Enter the 4-digit "ASCII Value" by scanning each digit in the *Numeric Bar Codes* on page D-1.
3. To correct an error or change the selection, scan CANCEL.

To enable FN1 Substitution for Wedge, scan the **Enable Keyboard Wedge FN1 Substitution** bar code on page 5-14.

To enable FN1 Substitution for USB HID Keyboard, scan the **Enable USB Keyboard FN1 Substitution** bar code on page 7-12.

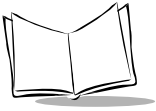

Transmit “No Read” Message

Scan a bar code below to select whether or not a “No Read” message is transmitted. When enabled, the characters NR are transmitted when a bar code is not decoded. When disabled, if a symbol does not decode, nothing is sent to the host.



Enable No Read



***Disable No Read**

Synapse Interface

The auto-detection of a Synapse cable needs to vary in duration depending on the type of Synapse connection. If a scanner is connected to another scanner using a Synapse cable then the Auxiliary Synapse Port connection should be used. In all other cases, where the cable is used, the default setting is recommended.

Should the user want to disconnect and reconnect the scanner from a Synapse cable that is connected to a live host via a Synapse, then the "Plug and Play" setting should be used. This setting should not be changed from the default if an on-board wedge host is enabled.

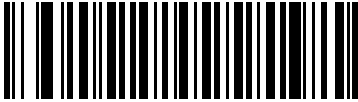

***Standard Synapse Connection**



Auxiliary Synapse Port Connection

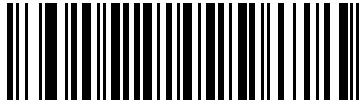

"Plug and Play" Synapse Connection

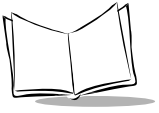

LS 2208 Product Reference Guide



Chapter 14

Advanced Data Formatting

Introduction

Advanced Data Formatting (ADF) is a means of customizing data before transmission to your host device. Scan data can be edited to suit your particular requirements.

ADF can be implemented through scanning a related series of bar codes, which begin on page 14-8, or by installing the 123Scan utility (see Chapter 11, *123Scan*) which allows the scanner to be setup and programmed with Advanced Data Formatting (ADF) Rules.

Note: *If you are using the Wand interface with your scanner, you will not be able to use ADF rules to format your data unless convert all Bar Codes to Code 39 is enabled on page 9-7.*

Rules: Criteria Linked to Actions

In ADF, data is customized through **rules**. These rules perform detailed actions when the data meets certain criteria. One rule may consist of single or multiple criteria applied to single or multiple actions.

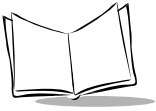

For instance, a data formatting rule could be the following:

- Criteria:** *When scan data is Code 39, length 12, and data at the start position is the string "129",*
- Actions:** *pad all sends with zeros to length 8,
send all data up to X,
send a space.*

If a Code 39 bar code of 1299X1559828 is scanned, the following is transmitted: 00001299<space>. If a Code 39 bar code of 1299X15598 is scanned, this rule is ignored because the length criteria has not been met.

The rule specifies the editing conditions and requirements before data transmission occurs.

Using ADF Bar Codes

When you program a rule, make sure the rule is logically correct. Plan ahead before you start scanning.

To program each data formatting rule:

- **Start the Rule.** Scan the **Begin New Rule bar code on page 14-8.**
- **Criteria.** Scan the bar codes for all pertinent criteria. Criteria can include code type (e.g., Code 128), code length, or data that contains a specific character string (e.g., the digits "129"). These options are described in *Criteria on page 14-12.*
- **Actions.** Scan all actions related to, or affecting, these criteria. The actions of a rule specify how to format the data for transmission. These options are described in *ADF Bar Code Menu Example on page 14-3.*
- **Save the Rule.** Scan the **Save Rule bar code on page 14-9.** This places the rule in the "top" position in the rule buffer.
- If you make errors during this process, some special-purpose bar codes may be useful: **Erase Criteria and Start Again, Erase Actions and Start Again, Erase Previously Saved Rule,** etc.

Criteria, actions, and entire rules may be erased by scanning the appropriate bar code (see page 14-9).

Beeper Definitions on page 2-2 help guide you through the programming steps.

ADF Bar Code Menu Example

This section provides an example of how ADF rules are entered and used for scan data.

An auto parts distribution center wants to encode manufacturer ID, part number, and destination code into their own Code 128 bar codes. The distribution center also has products that carry UPC bar codes, placed there by the manufacturer. The Code 128 bar codes have the following format:

MMMMMPPPPDD

Where: M = Manufacturer ID
 P = Part Number
 D = Destination Code

The distribution center uses a PC with dedicated control characters for manufacturer ID <CTRL M>, part number <CTRL P>, and destination code <CTRL D>. At this center the UPC data is treated as manufacturer ID code.

The following rules need to be entered:

When scanning data of code type Code 128, send the next 5 characters, send the manufacturer ID key <CTRL M>, send the next 5 characters, send the part number key <CTRL P>, send the next 2 characters, send the destination code key <CTRL D>.

When scanning data of code type UPC/EAN, send all data, send the manufacturer ID key <CTRL M>.

To enter these rules, follow the steps below:

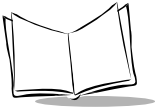

Rule 1: The Code 128 Scanning Rule

Step	Bar Code	On Page	Beep Indication
1	Begin New Rule	14-8	High High
2	Code 128	14-12	High High
3	Send next 5 characters	14-25	High High
4	Send <CTRL M>	14-47	High High
5	Send next 5 characters	14-25	High High
6	Send <CTRL P>	14-48	High High
7	Send next 2 characters	14-25	High High
8	Send <CTRL D>	14-46	High High
9	Save Rule	14-9	High Low High Low

Rule 2: The UPC Scanning Rule

Step	Bar Code	On Page	Beep Indication
1	Begin New Rule	14-8	High High
2	UPC/EAN	14-13	High High
3	Send all remaining data	14-25	High High
4	Send <CTRL M>	14-47	High High
5	Save Rule	14-9	High Low High Low

If you made any mistakes while entering this rule, scan the **Quit Entering Rules** bar code on page 14-10. If you already saved the rule, scan the **Erase Previously Saved Rule** bar code on page 14-9.

Alternate Rule Sets

ADF rules may be grouped into one of four alternate sets which can be turned on and off when needed. This is useful when you want to format the same message in different ways. For example, a Code 128 bar code contains the following information:

Class (2 digits), Stock Number (8) digits, Price (5 digits)

This bar code might look like this:

245671243701500

where:

Class = 24

Stock Number = 56712437

Price = 01500

Ordinarily you would send this data as follows:

24 (class key)

56712437 (stock key)

01500 (enter key)

But, when there is a sale, you may want to send only the following:

24 (class key)

56712437 (stock key)

and the cashier will key the price manually.

To implement this, you would first enter an ADF rule that applies to the normal situation. This rule may look like this:

When scanning a bar code of length 15, send the next 2 characters, send the class key, send the next 8 characters, send the stock key, send the data that remains, send the Enter key.

The “sale” rule may look like this:

When scanning a bar code of length 15, send the next 2 characters, send the class key, send the next 8 characters, send the stock key.

To switch between the two sets of rules, a “switching rule” must be programmed. This rule specifies what type of bar code must be scanned to switch between the rule sets. For example, in the case of the “sale” rule above, the rule programmer wants the cashier to scan the bar code “M” before a sale. To do this, a rule can be entered as follows:

When scanning a bar code of length 1 that begins with “M”, select rule set number 1.

Another rule could be programmed to switch back.

When scanning a bar code of length 1 that begins with “N”, turn off rule set number 1.

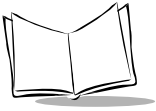

The switching back to normal rules can also be done in the “sale” rule. For example, the rule may look like this:

When scanning a bar code of length 15, send the next 2 characters, send the class key, send the next 8 characters, send the stock key, turn off rule set 1.

It is recommended that you scan the **Disable All Rule Sets** bar code on page 14-11 after programming a rule belonging to an alternate rule set.

In addition to enabling and disabling rule sets within the rules, you can enable or disable them by scanning the appropriate bar codes on 14-11.

Rules Hierarchy (in Bar Codes)

The order of programming individual rules is important. The most general rule should be programmed last.

All programmed rules are stored in a buffer. As they are programmed, they are stored at the “top” of a rules list. If three rules have been created, the list would be configured as follows:

Third Rule

Second Rule

First Rule

When data is scanned, the rules list is checked from top to bottom to determine if the criteria matches (and therefore, if the actions should occur). Input is modified into the data format specified by the first matching set of criteria it finds. Be sure that your most general rule is the last one programmed.

For example, if the THIRD rule states:

When scanning a bar code of any length, send all data, then send the ENTER key.

And the SECOND rule states:

When scanning a Code 128 bar code of length 12, send the first four characters, then send the ENTER key, then send all remaining data.

If a Code 128 bar code of length 12 were scanned, the THIRD rule would be in effect. The SECOND rule would appear to not function.

Note also that ADF rules are actually created when you use the standard data editing functions. Scan options are entered as ADF rules, and the hierarchy mentioned above also

applies to them. For the LS 2208, this applies to prefix/suffix programming in the parameter *Scan Data Transmission Format*.

These rules reside in the same “rule list” as ADF Rules, so the order of their creation is also important.

Default Rules

Every unit has a default rule to send all scan data. Units with custom software may have one or more default rules burned in. The rules hierarchy checks user programmable rules first, then the default rules. Default rules can be disabled by entering the following general rule in the user programmable buffer:

When receiving scan data, send all data.

Since this rule always applies, ADF will never go into the default rules.

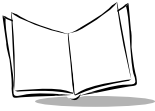

Special Commands

Pause Duration

This parameter along with the Send Pause parameter on page -29 allows a pause to be inserted in the data transmission. Pauses are set by scanning a two-digit number (i.e., two bar codes), and are measured in 0.1 second intervals. For example, scanning bar codes “0” and “1” inserts a 0.1 second pause; “0” and “5” gives you a 0.5 second delay. Numeric bar codes begin on page D-1 in *Numeric Bar Codes*. If you make an error or wish to change your selection, scan **Numeric Cancel** on page D-4.



Pause Duration

Begin New Rule

Scan this bar code to start entering a new rule.



Begin New Rule

Save Rule

Scan this bar code to save the rule you entered.



Save Rule

Erase

Use these bar codes to erase criteria, actions, or rules.



**Erase Criteria And
Start Again**



**Erase Actions And
Start Again**



**Erase Previously
Saved Rule**



Erase All Rules

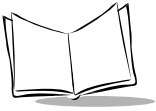

Quit Entering Rules

Scan this bar code to quit entering rules.



Quit Entering Rules

Disable Rule Set

Use these bar codes to disable rule sets.



Disable Rule Set 1



Disable Rule Set 2



Disable Rule Set 3



Disable Rule Set 4



Disable All Rule Sets

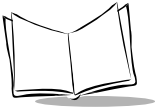

Criteria

Code Types

Select any number of code types to be affected. All selected codes must be scanned in succession, prior to selecting other criteria. *If you don't select a code type, all code types will be affected.*



Code 39



Codabar



RSS 14



RSS Limited



RSS Expanded



Code 128

Scan the bar codes for all code types desired before selecting other criteria.



D 2 OF 5



IATA 2 OF 5



I 2 OF 5



Code 93



UPC-A



UPC-E



EAN-8



EAN-13

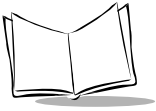

Code Types (continued)



MSI



UCC/EAN 128



UPC-E1



Bookland EAN



Trioptic Code 39



Chinese 2 of 5



Coupon Code

Code Lengths

Define the number of characters the selected code type must contain. *If you don't select a code length, selected code types of any length will be affected.*

Scan these bar codes to define the number of characters the selected code types must contain. Select one length per rule only.



1 Character



2 Characters



3 Characters



4 Characters



5 Characters



6 Characters

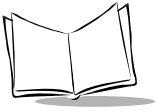

7 Characters



8 Characters



9 Characters



10 Characters



11 Characters



12 Characters

Code Lengths (continued)



13 Characters



14 Characters



15 Characters



16 Characters



17 Characters



18 Characters

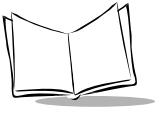

Code Lengths (continued)



19 Characters



20 Characters



21 Characters



22 Characters



23 Characters



24 Characters

Code Lengths (continued)



25 Characters



26 Characters



27 Characters



28 Characters



29 Characters



30 Characters

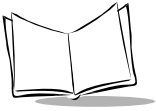

Message Containing A Specific Data String

Use this feature to select whether the formatting affects data that begins with a specific character or data string, or contains a specific character or data string.

There are 4 features:

- Specific String at Start
- Specific String, Any Location
- Any Message OK
- Rule Belongs to Set

Specific String at Start

Scan this bar code, then scan the bar codes representing the desired character or characters (up to a total of 8) in the *Alphanumeric Keyboard* on page 14-84.

After scanning the following bar code:

1. Enter a string using the *Alphanumeric Keyboard* beginning on page 14-84.
2. Scan **End Of Message** on page 14-90.



Specific String At Start

Specific String, Any Location

Scan this bar code, then, using the *Numeric Keypad* on page 14-22, scan a two-digit number representing the **position** (use a leading “zero” if necessary). Then scan the desired character or characters (up to a total of 8) on the *Alphanumeric Keyboard* on page 14-84, followed by the **End Of Message** bar code on page 14-90.

After scanning the following bar code:

1. Enter a location using the *Numeric Keypad* on page 14-22.
2. Enter a string using the *Alphanumeric Keyboard* beginning on page 14-84.
3. Scan **End Of Message** on page 14-90.



Specific String Any Location

Any Message OK

By not scanning any bar code, all selected code types are formatted, regardless of information contained.

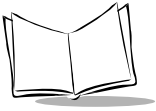

Numeric Keypad

Bar codes on this page should not be confused with those on the alphanumeric keyboard.



0



1



2



3



4



5



6



7



8



9



Cancel

Rule Belongs To Set

Select the set a rule belongs to. (There are four possible rule sets.) Refer to *Alternate Rule Sets* on page 14-4 for more information about rule sets.

Scan a bar code below to select which set a rule belongs to.



Rule Belongs To Set 1



Rule Belongs To Set 2



Rule Belongs To Set 3



Rule Belongs To Set 4

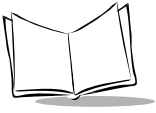

Actions

Select how to format the data for transmission.

Send Data

Send all data that remains, send all data up to a specific character selected from the *Alphanumeric Keyboard* on page 14-84, or send the next N characters. N = any number from 1 to 254, selected from the *Alphanumeric Keyboard*.

Use these bar codes to send data.



**Send Data Up To
Character**



**Send All Data That Re-
mains**



Send Next Character



**Send Next
2 Characters**



**Send Next
3 Characters**



**Send Next
4 Characters**



**Send Next
5 Characters**



**Send Next
6 Characters**



**Send Next
7 Characters**

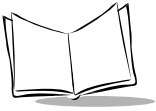

Send Data (continued)



**Send Next
8
Characters**



**Send Next
9
Characters**



**Send Next
10
Characters**



**Send Next
11
Characters**



**Send Next
12
Characters**



**Send Next
13
Characters**



**Send Next
14
Characters**



**Send Next
15
Characters**



**Send Next
16
Characters**



**Send Next
17
Characters**

Send Data (continued)



**Send Next
18 Characters**



**Send Next
19 Characters**



**Send Next
20 Characters**

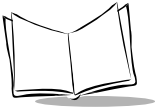

Setup Field(s)

Table 14-1. Setup Field(s) Definitions

Parameter	Description	Page
Move Cursor		
Move Cursor To a Character	Scan the Move Cursor To Character bar code on page 14-29, then any printable ASCII character from the <i>Alphanumeric Keyboard</i> . When this is used, the cursor moves to the position after the matching character. If the character is not there, the rule fails and ADF tries the next rule.	14-29
Move Cursor to Start of Data	Scan this bar code to move cursor to the beginning of the data.	14-29
Move Cursor Past a Character	This parameter moves the cursor past all sequential occurrences of a selected character. For example, if the selected character is 'A', then the cursor moves past 'A', 'AA', 'AAA', etc. Scan the Move Cursor Past Character bar code on page 14-29, then select a character from the <i>Alphanumeric Keyboard</i> . If the character is not there, the cursor does not move (i.e., has no effect).	14-29
Skip Ahead "N" Characters	Scan one of these bar codes to select the number of positions ahead you wish to move the cursor.	14-30
Skip Back "N" Characters	Scan one of these bar codes to select the number of positions back you wish to move the cursor.	14-32
Send Preset Value	Send Values 1 through 6 by scanning the appropriate bar code. These values must be set using the prefix/suffix values in Table 6-4 on page 6-25. Value 1 = Scan Suffix Value 2 = Scan Prefix Values 3-6 are not applicable	14-34

Move Cursor

Scan a bar code below to move the cursor in relation to a specified character. Then enter a character by scanning a bar code from the *Alphanumeric Keyboard* beginning on page 14-84.

Note: *If there is no match when the rule is interpreted and the rule fails, the next rule is checked.*



**Move Cursor To
Character**



Move Cursor To Start



**Move Cursor Past
Character**

Send Pause

Scan the bar code below to insert a pause in the transmission of data. The length of this pause is controlled by the value of the Pause Duration parameter.



Send Pause

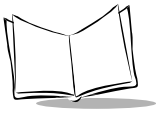

Skip Ahead

Use the following bar codes to skip ahead characters.



**Skip Ahead
1 Character**



**Skip Ahead
2 Characters**



**Skip Ahead
3 Characters**



**Skip Ahead
4 Characters**



**Skip Ahead
5 Characters**

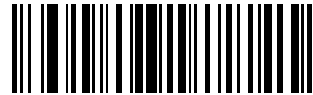

**Skip Ahead
6 Characters**



**Skip Ahead
7 Characters**

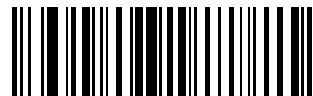

**Skip Ahead
8 Characters**

Skip Ahead (continued)



**Skip Ahead
9 Characters**



**Skip Ahead
10 Characters**

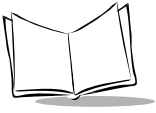

Skip Back

Use the following bar codes to skip back characters.



**Skip Back
1 Characters**



**Skip Back
2 Characters**



**Skip Back
3 Characters**



**Skip Back
4 Characters**



**Skip Back
5 Characters**



**Skip Back
6 Characters**



**Skip Back
7 Characters**



**Skip Back
8 Characters**

Skip Back (continued)



**Skip Back
9 Characters**



**Skip Back
10 Characters**

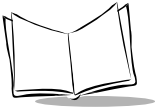

Send Preset Value

Use these bar codes to send preset values. These values must be set using the prefix/suffix values in Table 6-4 on page 6-23.



Send Value 1



Send Value 2

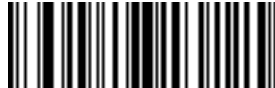

Send Value 3



Send Value 4



Send Value 5



Send Value 6

Modify Data

Modify data in the ways listed. The following actions work for all send commands that follow it within a rule. If you program *pad zeros to length 6*, *send next 3 characters*, *stop padding*, *send next 5 characters*, three zeros are added to the first send, and the next send is unaffected by the padding. These options do not apply to the **Send Keystroke** or **Send Preset Value** options.

Remove All Spaces

To remove all spaces in the send commands that follow, scan this bar code.

Crunch All Spaces

To leave one space between words, scan this bar code. This also removes all leading and trailing spaces.

Stop Space Removal

Scan this bar code to disable space removal.

Remove Leading Zeros

Scan this bar code to remove all leading zeros.

Stop Zero Removal

Scan this bar code to disable the removal of zeros.

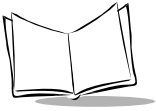

Use the bar codes below to modify data.



Remove All Spaces



Crunch All Spaces



Stop Space Removal



**Remove Leading
Zeros**



Stop Zero Removal

Pad Data with Spaces

To pad data to the left, scan the bar code containing the desired number of spaces. This parameter is activated by Send commands.



**Pad Spaces To
Length 1**



**Pad Spaces To
Length 2**



**Pad Spaces To
Length 3**



**Pad Spaces To
Length 4**



**Pad Spaces To
Length 5**



**Pad Spaces To
Length 6**



**Pad Spaces To
Length 7**



**Pad Spaces To
Length 8**

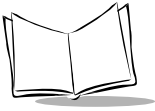

Pad Data with Spaces (continued)



**Pad Spaces To
Length 9**



**Pad Spaces To
Length 10**

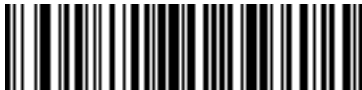

**Pad Spaces To
Length 11**



**Pad Spaces To
Length 12**

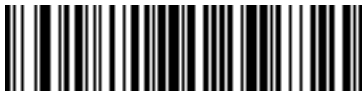

**Pad Spaces To
Length 13**



**Pad Spaces To
Length 14**

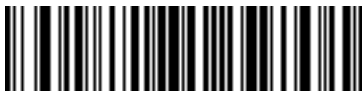

**Pad Spaces To
Length 15**



**Pad Spaces To
Length 16**

Pad Data with Spaces (continued)



**Pad Spaces To
Length 17**



**Pad Spaces To
Length 18**



**Pad Spaces To
Length 19**



**Pad Spaces To
Length 20**



**Pad Spaces To
Length 21**



**Pad Spaces To
Length 22**



**Pad Spaces To
Length 23**



**Pad Spaces To
Length 24**

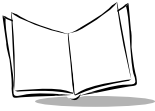

Pad Data with Spaces (continued)



**Pad Spaces To
Length 25**



**Pad Spaces To
Length 26**

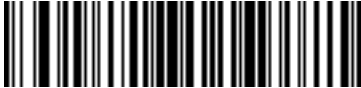

**Pad Spaces To
Length 27**



**Pad Spaces To
Length 28**



**Pad Spaces To
Length 29**



**Pad Spaces To
Length 30**



Stop Pad Spaces

Pad Data with Zeros

To pad data to the left, scan the bar code containing the desired number of zeros. This parameter is activated by Send commands.



**Pad Zeros To
Length 1**



**Pad Zeros To
Length 2**



**Pad Zeros To
Length 3**



**Pad Zeros To
Length 4**



**Pad Zeros To
Length 5**



**Pad Zeros To
Length 6**



**Pad Zeros To
Length 7**



**Pad Zeros To
Length 8**

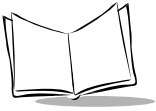

Pad Data with Zeros (continued)



**Pad Zeros To
Length 9**



**Pad Zeros To
Length 10**



**Pad Zeros To
Length 11**



**Pad Zeros To
Length 12**



**Pad Zeros To
Length 13**



**Pad Zeros To
Length 14**



**Pad Zeros To
Length 15**



**Pad Zeros To
Length 16**

Pad Data with Zeros (continued)



**Pad Zeros To
Length 17**



**Pad Zeros To
Length 18**



**Pad Zeros To
Length 19**



**Pad Zeros To
Length 20**



**Pad Zeros To
Length 21**



**Pad Zeros To
Length 22**



**Pad Zeros To
Length 23**



**Pad Zeros To
Length 24**

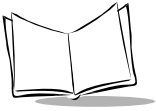

Pad Data with Zeros (continued)



**Pad Zeros To
Length 25**



**Pad Zeros To
Length 26**



**Pad Zeros To
Length 27**



**Pad Zeros To
Length 28**



**Pad Zeros To
Length 29**



**Pad Zeros To
Length 30**



Stop Pad Zeros

Beeps

Select a beep sequence for each ADF rule.



Beep Once



Beep Twice



Beep Three Times

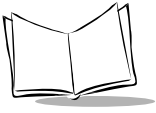

Send Keystroke (Control Characters and Keyboard Characters)

Control Characters

Scan the "Send ___" bar code for the keystroke you wish to send.



Send Control 2



Send Control A



Send Control B



Send Control C



Send Control D



Send Control E



Send Control F



Send Control G

Control Characters (continued)



Send Control H



Send Control I



Send Control J



Send Control K



Send Control L



Send Control M



Send Control N



Send Control O

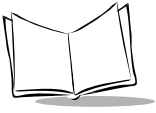

Control Characters (continued)



Send Control P



Send Control Q



Send Control R



Send Control S



Send Control T



Send Control U



Send Control V



Send Control W

Control Characters (continued)



Send Control X



Send Control Y



Send Control Z



Send Control [



**Send Control **



Send Control]



Send Control 6



Send Control -

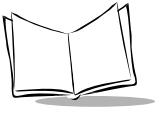

Keyboard Characters

Scan the “Send ___” bar code for the keyboard characters you wish to send.



Send Space



Send !



Send “



Send #



Send \$



Send %



Send &



Send ‘

Keyboard Characters (continued)



Send (



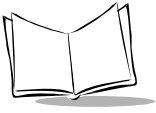

Keyboard Characters (continued)



Send 0



Send 1



Send 2



Send 3



Send 4



Send 5



Send 6



Send 7

Keyboard Characters (continued)



Send 8



Send 9



Send :



Send ;



Send <



Send =



Send >



Send ?

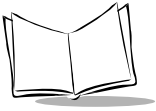

Keyboard Characters (continued)



Send @



Send A



Send B



Send C



Send D



Send E



Send F



Send G

Keyboard Characters (continued)



Send H



Send I



Send J



Send K



Send L



Send M



Send N



Send O

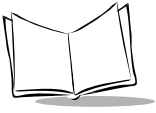

Keyboard Characters (continued)



Send P



Send Q



Send R



Send S



Send T



Send U



Send V



Send W

Keyboard Characters (continued)



Send X



Send Y



Send Z



Send [



**Send **



Send]



Send ^



Send _

Keyboard Characters (continued)



Send h



Send i



Send j



Send k



Send l



Send m



Send n



Send o

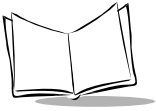

Keyboard Characters (continued)



Send p



Send q



Send r



Send s



Send t



Send u



Send v



Send w

Keyboard Characters (continued)



Send x



Send y



Send z



Send {



Send |



Send }



Send ~

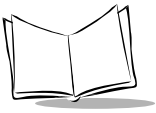

Send ALT Characters



Send Alt 2



Send Alt A



Send Alt B



Send Alt C



Send Alt D



Send Alt E



Send Alt F



Send Alt G

Send ALT Characters (continued)



Send Alt H



Send Alt I



Send Alt J



Send Alt K



Send Alt L



Send Alt M



Send Alt N



Send Alt O

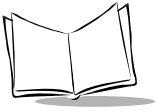

Send ALT Characters (continued)



Send Alt P



Send Alt Q



Send Alt R



Send Alt S



Send Alt T



Send Alt U



Send Alt V



Send Alt W

Send ALT Characters (continued)



Send Alt X



Send Alt Y



Send Alt Z



Send Alt [



**Send Alt **



Send Alt]



Send Alt 6



Send Alt -

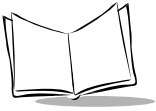

Send Keypad Characters



Send Keypad *



Send Keypad +



Send Keypad -



Send Keypad .



Send Keypad /



Send Keypad 0



Send Keypad 1



Send Keypad 2



Send Keypad 3



Send Keypad 4

Send Keypad Characters (continued)



Send Keypad 5



Send Keypad 6



Send Keypad 7



Send Keypad 8



Send Keypad 9



Send Keypad Enter



Send Keypad Numlock

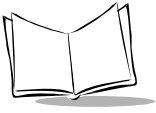

Send Keypad Characters (continued)



Send Break Key



Send Delete Key



Send Page Up Key



Send End Key



Send Page Down Key



Send Pause Key



Send Scroll Lock Key



Send Backspace Key



Send Tab Key



Send Print Screen Key

Send Keypad Characters (continued)



Send Insert Key



Send Home Key



Send Enter Key



Send Escape Key



Send Up Arrow Key



Send Down Arrow Key



Send Left Arrow Key



Send Right Arrow Key

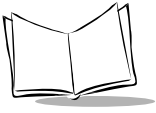

Send Function Key



Send F1 Key



Send F2 Key



Send F3 Key



Send F4 Key



Send F5 Key



Send F6 Key



Send F7 Key



Send F8 Key



Send F9 Key



Send F10 Key

Send Function Key (continued)



Send F11 Key



Send F12 Key



Send F13 Key



Send F14 Key



Send F15 Key



Send F16 Key



Send F17 Key



Send F18 Key



Send F19 Key



Send F20 Key

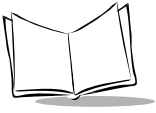

Send Function Key (continued)



Send F21 Key



Send F22 Key



Send F23 Key



Send F24 Key

Send Function Key (continued)



Send PF1 Key



Send PF2 Key



Send PF3 Key



Send PF4 Key



Send PF5 Key



Send PF6 Key



Send PF7 Key



Send PF8 Key



Send PF9 Key



Send PF10 Key

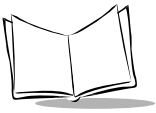

Send Function Key (continued)



Send PF11 Key



Send PF12 Key



Send PF13 Key



Send PF14 Key



Send PF15 Key



Send PF16 Key



Send PF17 Key



Send PF18 Key



Send PF19 Key



Send PF20 Key

Send Function Key (continued)



Send PF21 Key



Send PF22 Key



Send PF23 Key



Send PF24 Key



Send PF25 Key



Send PF26 Key



Send PF27 Key



Send PF28 Key



Send PF29 Key



Send PF30 Key

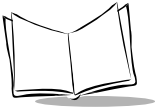

Send Right Control Key

The “Send Right Control Key” action will send a tap (press and release) of the Right Control Key.



Send Right Control Key

Send Graphic User Interface (GUI) Characters

The “Send Graphic User Interface Character” actions will tap the specified key while holding the System Dependent Graphic User Interface (GUI) Key. The definition of the Graphic User Interface key is dependant upon the attached system:



Send GUI 0



Send GUI 1



Send GUI 2



Send GUI 3

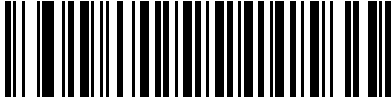

Send GUI 4

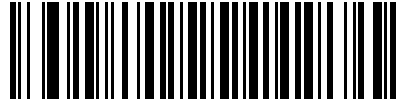

Send GUI 5

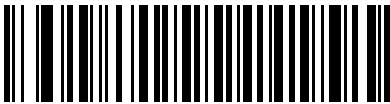

Send GUI 6

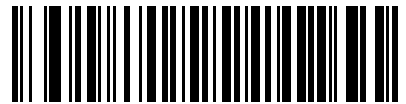

Send GUI 7



Send GUI 8

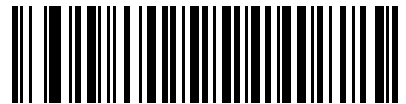

Send GUI 9

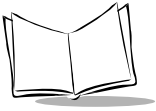

Send GUI A

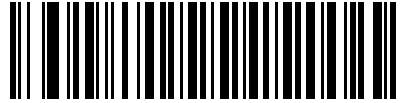

Send GUI B

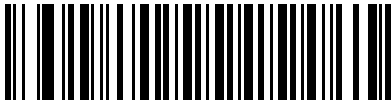

Send GUI C

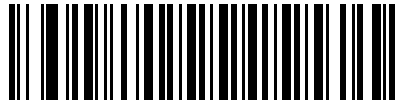

Send GUI D



Send GUI E



Send GUI F

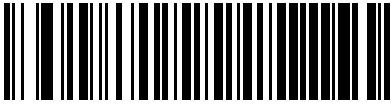

Send GUI G



Send GUI H

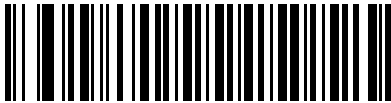

Send GUI I



Send GUI J

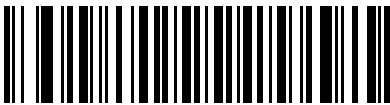

Send GUI K

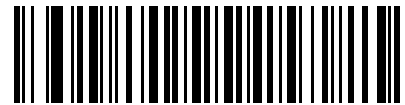

Send GUI L

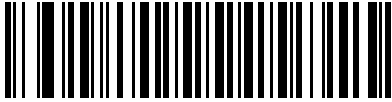
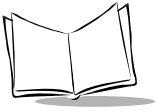

Send GUI M

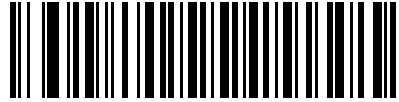

Send GUI N

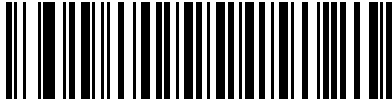

Send GUI O

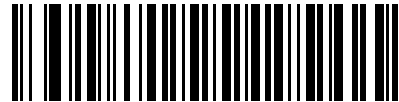

Send GUI P



Send GUI Q



Send GUI R



Send GUI S

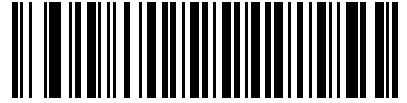

Send GUI T



Send GUI U

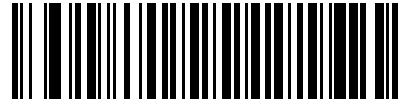

Send GUI V



Send GUI W



Send GUI X

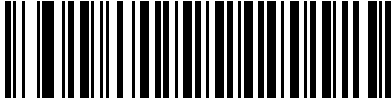
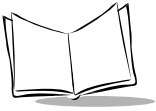

Send GUI Y



Send GUI Z

Turn On/Off Rule Sets

Use these bar codes to turn rule sets on and off.



Turn On Rule Set 1



Turn On Rule Set 2



Turn On Rule Set 3



Turn On Rule Set 4



Turn Off Rule Set 1



Turn Off Rule Set 2



Turn Off Rule Set 3



Turn Off Rule Set 4

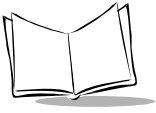

Alphanumeric Keyboard



Space



#



\$



%



*



+



-
(Dash)



.



/



!

Alphanumeric Keyboard (continued)



“



&



’



(



)



:



;



<



=



>

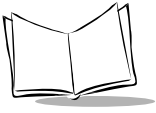

Alphanumeric Keyboard (continued)



?



@



[



\



]



^



(Underscore)



'

Alphanumeric Keyboard (continued)

Bar codes on this page should not be confused with those on the numeric keypad.



0



1



2



3



4



5



6



7



8



9

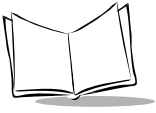

Alphanumeric Keyboard (continued)



A



B



C



D



E



F



G



H



I



J

Alphanumeric Keyboard (continued)



K



L



M



N



O



P



Q



R



S



T

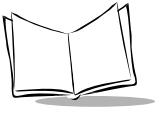

Alphanumeric Keyboard (continued)



U



V



W



X



Y



Z



Cancel



End Of Message

Alphanumeric Keyboard (continued)



a



b



c



d



e



f



g



h



i



j

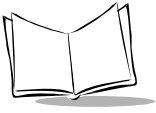

Alphanumeric Keyboard (continued)



k



l



m



n



o



p



q



r



s



t

Alphanumeric Keyboard (continued)



u



v



w



x



y



z



{



|



}



~

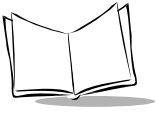

LS 2208 Product Reference Guide

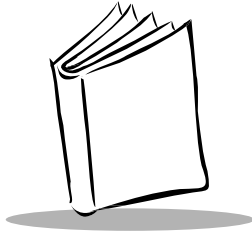

Appendix A

Standard Default Parameters

Table A-1. Standard Default Parameters Table

Parameter	Default	Page Number
User Preferences		
Set Default Parameter	All Defaults	4-4
Beeper Tone	Medium	4-5
Beeper Volume	High	4-6
Power Mode	Continuous On	4-7
Laser On Time	3.0 Sec	4-8
Beep After Good Decode	Enable	4-9
Keyboard Wedge Host Parameters		
Keyboard Wedge Host Type	IBM PC/AT& IBM PC Compatibles ¹	5-4
Country Types (Country Codes)	North American	5-5
¹ User selection is required to configure this interface and this is the most common selection.		

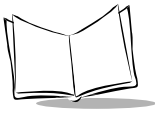

Table A-1. Standard Default Parameters Table (Continued)

Parameter	Default	Page Number
Ignore Unknown Characters	Transmit	5-8
Keystroke Delay	No Delay	5-9
Intra-Keystroke Delay	Disable	5-10
Alternate Numeric Keypad Emulation	Disable	5-10
Caps Lock On	Disable	5-11
Caps Lock Override	Disable	5-12
Convert Wedge Data	No Convert	5-12
Function Key Mapping	Disable	5-13
FN1 Substitution	Disable	5-14
Send and Make Break	Send	5-14
RS-232 Host Parameters		
RS-232 Host Types	Standard ¹	6-7
Baud Rate	9600	6-10
Parity Type	None	6-12
Stop Bit Select	1 Stop Bit	6-13
Data Bits	8-Bit	6-13
Check Receive Errors	Enable	6-14
Hardware Handshaking	None	6-16
Software Handshaking	None	6-17
¹ User selection is required to configure this interface and this is the most common selection.		

Table A-1. Standard Default Parameters Table (Continued)

Parameter	Default	Page Number
Host Serial Response Time-out	2 Sec	6-20
RTS Line State	Low RTS	6-21
Beep on <BEL>	Disable	6-21
Intercharacter Delay	0 msec	6-22
Nixdorf Beep/LED Options	Normal Operation	6-23
Ignore Unknown Characters	Send Bar Code	6-24
USB Host Parameters		
USB Device Type	HID Keyboard Emulation	7-5
USB Country Keyboard Types (Country Codes)	North American	7-6
USB Keystroke Delay	No Delay	7-9
USB CAPS Lock Override	Disable	7-10
USB Ignore Unknown Characters	Enable	7-10
Emulate Keypad	Disable	7-12
USB Keyboard FN1 Substitution	Disable	7-12
Function Key Mapping	Disable	7-13
Simulated Caps Lock	Disable	7-13
Convert Case	No Case Conversion	7-14
IBM 468X/469X Host Parameters		
Port Address	None Selected	8-4
¹ User selection is required to configure this interface and this is the most common selection.		

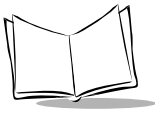

Table A-1. Standard Default Parameters Table (Continued)

Parameter	Default	Page Number
Convert Unknown to Code 39	Disable	8-5
Wand Emulation Host Parameters		
Wand Emulation Host Types	Symbol OmniLink Interface Controller ¹	9-4
Leading Margin	80 msec	9-5
Polarity	Bar High/Margin Low	9-6
Ignore Unknown Characters	Ignore	9-7
Convert All Bar Codes to Code 39	Disable	9-7
Convert Code 39 to Full ASCII	Disable	9-8
Undecoded Scanner Emulation		
Beep Style	Beep on Successful Transmit	10-5
Parameter Pass-Through	Parameter Process and Pass Through	10-6
Convert Newer Code Types	Convert Newer Code Types	10-7
Module Width	20 μ s	10-8
Convert All Bar Codes to Code 39	Do Not Convert to Code 39	10-9
Code 39 Full ASCII Conversion	Disable	10-9
Transmission Timeout	3 seconds	10-10
¹ User selection is required to configure this interface and this is the most common selection.		

Table A-1. Standard Default Parameters Table (Continued)

Parameter	Default	Page Number
Ignore Unknown Characters	Ignore Unknown Characters	10-11
Leading Margin	2 ms	10-12
Check for Decode LED	Check for Decode LED	10-13
123Scan Configuration Tool		
123Scan Configuration	None ¹	11-2
UPC/EAN		
UPC-A	Enable	12-7
UPC-E	Enable	12-7
UPC-E1	Disable	12-8
EAN-8/JAN 8	Enable	12-9
EAN-13/JAN 13	Enable	12-9
Bookland EAN	Disable	12-10
Decode UPC/EAN/JAN Supplementals (2 and 5 digits)	Ignore	12-12
UPC/EAN/JAN Supplemental Redundancy	7	12-13
Transmit UPC-A Check Digit	Enable	12-14
Transmit UPC-E Check Digit	Enable	12-14
Transmit UPC-E1 Check Digit	Enable	12-15
UPC-A Preamble	System Character	12-16
¹ User selection is required to configure this interface and this is the most common selection.		

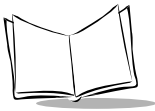

Table A-1. Standard Default Parameters Table (Continued)

Parameter	Default	Page Number
UPC-E Preamble	System Character	12-16
UPC-E1 Preamble	System Character	12-18
Convert UPC-E to A	Disable	12-19
Convert UPC-E1 to A	Disable	12-20
EAN-8/JAN-8 Extend	Disable	12-21
UPC/EAN Security Levels	0	12-22
UCC Coupon Extended Code	Disable	12-24
Code 128		
Code 128	Enable	12-25
UCC/EAN-128	Enable	12-26
Code 39		
Code 39	Enable	12-27
Trioptic Code 39	Disable	12-28
Convert Code 39 to Code 32 (Italian Pharmacy Code)	Disable	12-29
Code 32 Prefix	Disable	12-30
Set Length(s) for Code 39	2 to 55	12-31
Code 39 Check Digit Verification	Disable	12-31
Transmit Code 39 Check Digit	Disable	12-33
Code 39 Full ASCII Conversion	Disable	12-35
¹ User selection is required to configure this interface and this is the most common selection.		

Table A-1. Standard Default Parameters Table (Continued)

Parameter	Default	Page Number
Buffer Code 39	Disable	12-36
Code 93		
Code 93	Disable	12-40
Set Length(s) for Code 93	4 to 55	12-41
Code 11		
Code 11	Disable	12-43
Set Lengths for Code 11	4 to 55	12-44
Code 11 Check Digit Verification	Disable	12-46
Transmit Code 11 Check Digit(s)	Disable	12-47
Interleaved 2 of 5 (ITF)		
Interleaved 2 of 5 (ITF)	Enable	12-48
Set Lengths for I 2 of 5	14	12-49
I 2 of 5 Check Digit Verification	Disable	12-51
Transmit I 2 of 5 Check Digit	Disable	12-52
Convert I 2 of 5 to EAN 13	Disable	12-53
Discrete 2 of 5 (DTF)		
Discrete 2 of 5	Disable	12-54
Set Length(s) for D 2 of 5	12	12-55
Chinese 2 of 5		
¹ User selection is required to configure this interface and this is the most common selection.		

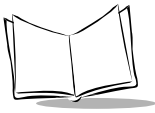
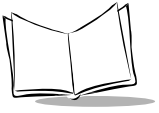

Table A-1. Standard Default Parameters Table (Continued)

Parameter	Default	Page Number
Enable/Disable Chinese 2 of 5	Disable	12-57
Codabar (NW - 7)		
Codabar	Disable	12-58
Set Lengths for Codabar	5 to 55	12-59
CLSI Editing	Disable	12-61
NOTIS Editing	Disable	12-62
MSI		
MSI	Disable	12-63
Set Length(s) for MSI	1 to 55	12-64
MSI Check Digits	One	12-66
Transmit MSI Check Digit	Disable	12-67
MSI Check Digit Algorithm	Mod 10/Mod 10	12-68
RSS (Reduced Space Symbology)		
RSS 14	Disable	12-69
RSS Limited	Disable	12-70
RSS Expanded	Disable	12-70
Convert RSS to UPC/EAN	Disable	12-71
Symbology - Specific Security Levels		
Redundancy Level	1	12-72
¹ User selection is required to configure this interface and this is the most common selection.		

Table A-1. Standard Default Parameters Table (Continued)

Parameter	Default	Page Number
UPC/EAN		
Miscellaneous Scanner Options		
Transmit Code ID Character	None	13-4
Prefix Value	7013 <CR><LF>	13-5
Suffix Value	7013 <CR><LF>	13-5
Scan Data Transmission Format	Data as is	13-7
FN1 Substitution Values	Set	13-9
Transmit "No Read" Message	Disable	13-10
Synapse Interface	Standard	13-11
¹ User selection is required to configure this interface and this is the most common selection.		



LS 2208 Product Reference Guide



Appendix B

Programming Reference

Symbol Code Identifiers

Table B-1. Symbol Code Characters

Code Character	Code Type
A	UPC-A, UPC-E, UPC-E1, EAN-8, EAN-13
B	Code 39, Code 32
C	Codabar
D	Code 128
E	Code 93
F	Interleaved 2 of 5
G	Discrete 2 of 5, or Discrete 2 of 5 IATA
H	Code 11
J	MSI
K	UCC/EAN-128
L	Bookland EAN
M	Trioptic Code 39

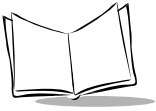

Table B-1. Symbol Code Characters (Continued)

Code Character	Code Type
N	Coupon Code
R	RSS Family
T	UCC Composite, TLC 39

AIM Code Identifiers

Each AIM Code Identifier contains the three-character string **Jcm** where:

- J = Flag Character (ASCII 93)
- c = Code Character (see Table B-2)
- m = Modifier Character (see Table B-3)

Table B-2. Aim Code Characters

Code Character	Code Type
A	Code 39, Code 39 Full ASCII, Code 32
C	Code 128, Coupon (Code 128 portion)
E	UPC/EAN, Coupon (UPC portion)
e	RSS Family
F	Codabar
G	Code 93
H	Code 11
I	Interleaved 2 of 5
M	MSI
S	D2 of 5, IATA 2 of 5
X	Code 39 Trioptic
X	Bookland EAN

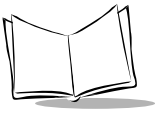

The modifier character is the sum of the applicable option values based on Table B-3.

Table B-3. Modifier Characters

Code Type	Option Value	Option
Code 39	0	No check character or Full ASCII processing.
	1	Reader has checked one check character.
	3	Reader has checked and stripped check character.
	4	Reader has performed Full ASCII character conversion.
	5	Reader has performed Full ASCII character conversion and checked one check character.
	7	Reader has performed Full ASCII character conversion and checked and stripped check character.
	Example: A Full ASCII bar code with check character W, A+I+MI+DW , is transmitted as J A7AIMID where 7 = (3+4).	
Trioptic Code 39	0	No option specified at this time. Always transmit 0.
	Example: A Trioptic bar code 412356 is transmitted as J X0412356	
Code 128	0	Standard data packet, no Function code 1 in first symbol position.
	1	Function code 1 in first symbol character position.
	2	Function code 1 in second symbol character position.
	Example: A Code (EAN) 128 bar code with Function 1 character ^{FNC1} in the first position, AIMID is transmitted as J C1AIMID	
I 2 of 5	0	No check digit processing.
	1	Reader has validated check digit.
	3	Reader has validated and stripped check digit.
	Example: An I 2 of 5 bar code without check digit, 4123, is transmitted as J I04123	
Codabar	0	No check digit processing.
	1	Reader has checked check digit.
	3	Reader has stripped check digit before transmission.
	Example: A Codabar bar code without check digit, 4123, is transmitted as J F04123	

Table B-3. Modifier Characters (Continued)

Code Type	Option Value	Option
Code 93	0	No options specified at this time. Always transmit 0.
	Example:A Code 93 bar code 012345678905 is transmitted as JG0012345678905	
MSI	0	Check digits are sent.
	1	No check digit is sent.
	Example:An MSI bar code 4123, with a single check digit checked, is transmitted as JM14123	
D 2 of 5	0	No options specified at this time. Always transmit 0.
	Example:A D 2 of 5 bar code 4123, is transmitted as JS04123	
UPC/EAN	0	Standard packet in full EAN country code format, which is 13 digits for UPC-A and UPC-E (not including supplemental data).
	1	Two-digit supplement data only.
	2	Five-digit supplement data only.
	4	EAN-8 data packet.
	Example:A UPC-A bar code 012345678905 is transmitted as JE00012345678905	
Bookland EAN	0	No options specified at this time. Always transmit 0.
	Example:A Bookland EAN bar code 123456789X is transmitted as JX0123456789X	
Code 11	0	Single check digit
	1	Two check digits
	3	Check characters validated but not transmitted.

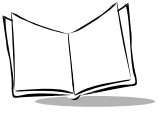

LS 2208 Product Reference Guide

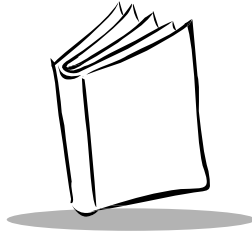

Appendix C

Sample Bar Codes

Code 39



UPC/EAN

UPC-A, 100 %

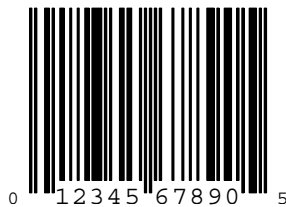

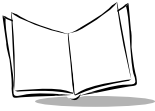

UPC/EAN (continued)

EAN-13, 100 %



Code 128



Interleaved 2 of 5



RSS 14

Note: *RSS 14 must be enabled to read the bar code below (see Enable RSS 14 on page 12-69).*



7612341562341



LS 2200/2208 Product Reference Guide

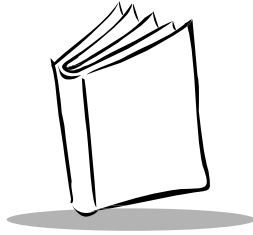

Appendix D

Numeric Bar Codes

0, 1

For parameters requiring specific numeric values, scan the appropriately numbered bar code(s).



0



1

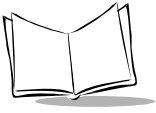

2, 3, 4

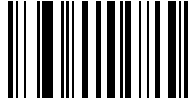

2

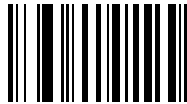

3



4

5, 6, 7



5



6

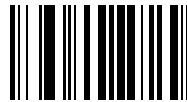

7

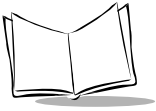

8, 9



8

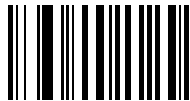

9

Cancel

If you make an error or wish to change your selection, scan the bar code below.



Cancel

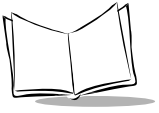

LS 2208 Product Reference Guide



Glossary

Aperture	The opening in an optical system defined by a lens or baffle that establishes the field of view.
AIM	Automatic Identification Manufacturers
ASCII	American Standard Code for Information Interchange. A 7 bit-plus-parity code representing 128 letters, numerals, punctuation marks, and control characters. It is a standard data transmission code in the U.S.
Autodiscrimination	The ability of an interface controller to determine the code type of a scanned bar code. After this determination is made, the information content is decoded.
Bar	The dark element in a printed bar code symbol.
Bar Code Density	The number of characters represented per unit of measurement (e.g., characters per inch).
Bar Height	The dimension of a bar measured perpendicular to the bar width.
Bar Width	Thickness of a bar measured from the edge closest to the symbol start character to the trailing edge of the same bar.
Baud Rate	A measure of the data flow or number of signaling events occurring per second. When one bit is the standard "event," this is a measure of bits per second (bps). For example, a baud rate of 50 means transmission of 50 bits of data per second.
Bit	Binary digit. One bit is the basic unit of binary information. Generally, eight consecutive bits compose one byte of data. The pattern of 0 and 1 values within the byte determines its meaning.

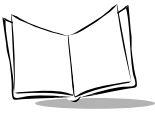

Byte	On an addressable boundary, eight adjacent binary digits (0 and 1) combined in a pattern to represent a specific character or numeric value. Bits are numbered from the right, 0 through 7, with bit 0 the low-order bit. One byte in memory is used to store one ASCII character.
CDRH	Center for Devices and Radiological Health. A federal agency responsible for regulating laser product safety. This agency specifies various laser operation classes based on power output during operation.
CDRH Class 1	This is the lowest power CDRH laser classification. This class is considered intrinsically safe, even if all laser output were directed into the eye's pupil. There are no special operating procedures for this class.
CDRH Class 2	No additional software mechanisms are needed to conform to this limit. Laser operation in this class poses no danger for unintentional direct human exposure.
Character	A pattern of bars and spaces which either directly represents data or indicates a control function, such as a number, letter, punctuation mark, or communications control contained in a message.
Character Set	Those characters available for encoding in a particular bar code symbology.
Check Digit	A digit used to verify a correct symbol decode. The scanner inserts the decoded data into an arithmetic formula and checks that the resulting number matches the encoded check digit. Check digits are required for UPC but are optional for other symbologies. Using check digits decreases the chance of substitution errors when a symbol is decoded.
Codabar	A discrete self-checking code with a character set consisting of digits 0 to 9 and six additional characters: (- \$: / , +).
Code 128	A high density symbology which allows the controller to encode all 128 ASCII characters without adding extra symbol elements.
Code 3 of 9 (Code 39)	A versatile and widely used alphanumeric bar code symbology with a set of 43 character types, including all uppercase letters, numerals from 0 to 9, and 7 special characters (- . / + % \$ and space). The code name is derived from the fact that 3 of 9 elements representing a character are wide, while the remaining 6 are narrow.
Code 93	An industrial symbology compatible with Code 39 but offering a full character ASCII set and a higher coding density than Code 39.

Code Length	Number of data characters in a bar code between the start and stop characters, not including those characters.
Continuous Code	A bar code or symbol in which all spaces within the symbol are parts of characters. There are no intercharacter gaps in a continuous code. The absence of gaps allows for greater information density.
Dead Zone	An area within a scanner's field of view, in which specular reflection may prevent a successful decode.
Decode	To recognize a bar code symbology (e.g., UPC/EAN) and then analyze the content of the specific bar code scanned.
Decode Algorithm	A decoding scheme that converts pulse widths into data representation of the letters or numbers encoded within a bar code symbol.
Depth of Field	The range between minimum and maximum distances at which a scanner can read a symbol with a certain minimum element width.
Discrete Code	A bar code or symbol in which the spaces between characters (intercharacter gaps) are not part of the code.
Discrete 2 of 5	A binary bar code symbology representing each character by a group of five bars, two of which are wide. The location of wide bars in the group determines which character is encoded; spaces are insignificant. Only numeric characters (0 to 9) and START/STOP characters may be encoded.
EAN	European Article Number. This European/International version of the UPC provides its own coding format and symbology standards. Element dimensions are specified metrically. EAN is used primarily in retail.
Element	Generic term for a bar or space.
Encoded Area	Total linear dimension occupied by all characters of a code pattern, including start/stop characters and data.
Host Computer	A computer that serves other terminals in a network, providing such services as computation, database access, supervisory programs, and network control.
IEC	International Electrotechnical Commission. This international agency regulates laser safety by specifying various laser operation classes based on power output during operation.

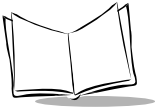

IEC (825) Class 1	This is the lowest power IEC laser classification. Conformity is ensured through a software restriction of 120 seconds of laser operation within any 1000 second window and an automatic laser shutdown if the scanner's oscillating mirror fails.
Intercharacter Gap	The space between two adjacent bar code characters in a discrete code.
Interleaved Bar Code	A bar code in which characters are paired together, using bars to represent the first character and the intervening spaces to represent the second.
Interleaved 2 of 5	A binary bar code symbology representing character pairs in groups of five bars and five interleaved spaces. Interleaving provides for greater information density. The location of wide elements (bar/spaces) within each group determines which characters are encoded. This continuous code type uses no intercharacter spaces. Only numeric (0 to 9) and START/STOP characters may be encoded.
LASER - Light Amplification by Stimulated Emission of Radiation	The laser is an intense light source. Light from a laser is all the same frequency, unlike the output of an incandescent bulb. Laser light is typically coherent and has a high energy density.
Laser Diode	A gallium-arsenide semiconductor type of laser connected to a power source to generate a laser beam. This laser type is a compact source of coherent light.
LED Indicator	A semiconductor diode (LED - Light Emitting Diode) used as an indicator, often in digital displays. The semiconductor uses applied voltage to produce light of a certain frequency determined by the semiconductor's particular chemical composition.
MIL	1 mil = 1 thousandth of an inch.
Misread (Misdecode)	A condition which occurs when the data output of a reader or interface controller does not agree with the data encoded within a bar code symbol.
Nominal	The exact (or ideal) intended value for a specified parameter. Tolerances are specified as positive and negative deviations from this value.
Nominal Size	Standard size for a bar code symbol. Most UPC/EAN codes are used over a range of magnifications (e.g., from 0.80 to 2.00 of nominal).
Parameter	A variable that can have different values assigned to it.

Percent Decode	The average probability that a single scan of a bar code would result in a successful decode. In a well-designed bar code scanning system, that probability should approach near 100%.
Print Contrast Signal (PCS)	Measurement of the contrast (brightness difference) between the bars and spaces of a symbol. A minimum PCS value is needed for a bar code symbol to be scannable. $PCS = (RL - RD) / RL$, where RL is the reflectance factor of the background and RD the reflectance factor of the dark bars.
Programming Mode	The state in which a scanner is configured for parameter values. See SCANNING MODE.
Quiet Zone	A clear space, containing no dark marks, which precedes the start character of a bar code symbol and follows the stop character.
Reflectance	Amount of light returned from an illuminated surface.
Resolution	The narrowest element dimension which is distinguished by a particular reading device or printed with a particular device or method.
RSS	Reduced Space Symbology: A family of space efficient symbologies developed by UCC.EAN.
Scan Area	Area intended to contain a symbol.
Scanner	An electronic device used to scan bar code symbols and produce a digitized pattern that corresponds to the bars and spaces of the symbol. Its three main components are: <ol style="list-style-type: none">1. Light source (laser or photoelectric cell) - illuminates a bar code.2. Photodetector - registers the difference in reflected light (more light reflected from spaces).3. Signal conditioning circuit - transforms optical detector output into a digitized bar pattern.
Scanning Mode	The scanner is energized, programmed, and ready to read a bar code.
Scanning Sequence	A method of programming or configuring parameters for a bar code reading system by scanning bar code menus.
Self-Checking Code	A symbology that uses a checking algorithm to detect encoding errors within the characters of a bar code symbol.
Space	The lighter element of a bar code formed by the background between bars.
Specular Reflection	The mirror-like direct reflection of light from a surface, which can cause difficulty decoding a bar code.

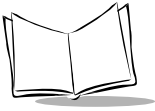

Start/Stop Character	A pattern of bars and spaces that provides the scanner with start and stop reading instructions and scanning direction. The start and stop characters are normally to the left and right margins of a horizontal code.
Substrate	A foundation material on which a substance or image is placed.
Symbol	A scannable unit that encodes data within the conventions of a certain symbology, usually including start/stop characters, quiet zones, data characters, and check characters.
Symbol Aspect Ratio	The ratio of symbol height to symbol width.
Symbol Height	The distance between the outside edges of the quiet zones of the first row and the last row.
Symbol Length	Length of symbol measured from the beginning of the quiet zone (margin) adjacent to the start character to the end of the quiet zone (margin) adjacent to a stop character.
Symbology	The structural rules and conventions for representing data within a particular bar code type (e.g. UPC/EAN, Code 39).
Tolerance	Allowable deviation from the nominal bar or space width.
UPC	Universal Product Code. A relatively complex numeric symbology. Each character consists of two bars and two spaces, each of which is any of four widths. The standard symbology for retail food packages in the United States.
Visible Laser Diode (VLD)	A solid state device which produces visible laser light.

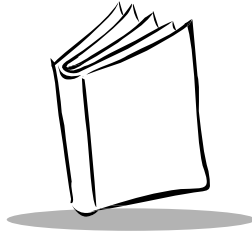

Index

Numerics

123Scan parameters 11-2

A

actions 14-3

ADF 14-1

actions 14-2, 14-24

move cursor 14-29

send data 14-24

setup fields 14-28

alphanumeric keyboard 14-84

alternate rule sets 14-4

bar code menu example 14-3

beep 14-45

code lengths 14-15

code types 14-12

criteria 14-2, 14-12

default rules 14-7

move cursor past a character 14-28

move cursor to a character 14-28

move cursor to start of data 14-28

numeric keypad 14-22

pad spaces 14-37

pad zeros 14-41

rules 14-1

rules hierarchy 14-6

send alt characters 14-62

send control characters 14-46

send function key 14-70

send keyboard characters 14-50

send keypad characters 14-66

send preset value 14-28

send value 14-34

skip ahead characters 14-30

skip ahead "n" characters 14-28

skip back characters 14-32

skip back "n" characters 14-28

space removal 14-34

special commands 14-8

specific data string 14-20

specific string

any location 14-21

any message ok 14-21

at start 14-20

rule belongs to set 14-23

turn off rule sets 14-83

zero removal 14-34

advanced data formatting 14-1

actions 14-2, 14-24

alphanumeric keyboard 14-84

alternate rule sets 14-4

bar code menu example 14-3

beep 14-45

code lengths 14-15

code types 14-12

criteria 14-2, 14-12

default rules 14-7

numeric keypad 14-22

pad spaces 14-37

pad zeros 14-41

rules 14-1

rules hierarchy 14-6

send alt characters 14-62

send control characters 14-46

send function key 14-70

send keyboard characters 14-50

send keypad characters 14-66

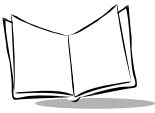

send preset value	14-34
setup fields	14-28
skip ahead characters	14-30
skip back characters	14-32
space removal	14-34
special commands	14-8
specific data string	14-20
turn off rule sets	14-83
zero removal	14-34
aiming	2-6
ASCII Values	6-25
assembling the stand	2-8

B

bar codes	
123Scan	11-2
beep after good decode	4-9
beeper tone	4-5
beeper volume	4-6
code 11	
lengths	12-45
code 39	
transmit buffer	12-38
code 93	
lengths	12-42
data options	13-4
pause duration	14-8
prefix/suffix values	13-5
transmit code ID character	13-4
discrete 2 of 5	
lengths	12-56
IBM 468X/469X	
convert unknown to code 39	8-5
default parameters	8-3
IBM 468X/469X parameters	
port address	8-4
interleaved 2 of 5	12-48
convert to EAN-13	12-53
lengths	12-49, 12-50
keyboard wedge	
alternate numeric keypad emulation	5-10
caps lock on	5-11
caps lock override	5-12
country keyboard types (country codes)	5-5
default table	5-3
host types	5-4
ignore unknown characters	5-8
intra-keystroke delay	5-10
keystroke delay	5-9
laser on time	4-8
miscellaneous	
scan data options	13-6
transmit no read msg	13-10
numeric bar codes	D-5
RS-232	
baud rate	6-9
Data Bits	6-13
default table	6-3
hardware handshaking	6-15
host serial response time-out	6-20
host types	6-7
intercharacter delay	6-22
RTS line state	6-21
stop bit select	6-21
RS-232 parameters	
check receive errors	6-14
parity	6-11
software handshaking	6-17
RS-232C	
beep on bel	6-21
set defaults	4-4
symbolologies	
bi-directional redundancy	12-77
bookland EAN	12-10
buffering	12-36
codabar	12-58
codabar CLSI editing	12-61
codabar lengths	12-59
codabar NOTIS editing	12-62
code 11	12-43
code 11 lengths	12-44
code 128	12-25
code 39	12-27
code 39 check digit verification	12-33
code 39 full ASCII	12-35

- code 39 lengths 12-31
 - code 39 transmit check digit . . . 12-34
 - code 93 12-40
 - code 93 lengths 12-41
 - convert UPC-E to UPC-A 12-19
 - convert UPC-E1 to UPC-A 12-20
 - default table 12-3
 - discrete 2 of 5 12-54
 - discrete 2 of 5 lengths 12-55
 - EAN zero extend 12-21
 - EAN-13/EAN-8 12-9
 - I 2 of 5 check digit verification . . 12-51
 - I 2 of 5 convert to EAN-13 12-53
 - I 2 of 5 transmit check digit 12-52
 - MSI 12-63
 - MSI check digit algorithm 12-68
 - MSI check digits 12-66
 - MSI lengths 12-64
 - MSI transmit check digit 12-67
 - supplementals 12-11
 - UCC coupon extended code . . 12-24
 - UCC/EAN-128 12-26
 - UPC-A preamble 12-16
 - UPC-A/E/E1 check digit 12-14
 - UPC-A/UPC-E 12-7
 - UPC-E preamble 12-17
 - UPC-E1 12-8
 - UPC/EAN
 - coupon code 12-24
 - security level 12-22
 - supp redundancy 12-13
 - UPC/EAN/JAN
 - supplemental redundancy 12-13
 - USB
 - caps lock override 7-10
 - country keyboard types 7-6
 - default table 7-4
 - device type 7-5
 - keystroke delay 7-9
 - unknown characters 7-11
 - wand emulation
 - code 39 full ASCII 9-8
 - convert all bar codes to code 39 . . 9-7
 - default table 9-3, 10-3
 - host types 9-4
 - leading margin (quiet zone) 9-5
 - polarity 9-6
 - unknown characters 9-7
- C**
- cables
 - installing 1-3
 - interface 1-4
 - removing cables 1-5
 - Caption Bar Code
 - Normal Operation 6-23
 - Send Bar Code 6-24
 - Character Set 6-25
 - codabar bar codes
 - CLSI editing 12-61
 - codabar 12-58
 - lengths 12-59
 - NOTIS editing 12-62
 - code 11 bar codes
 - code 11 12-43
 - lengths 12-44
 - code 128 bar codes
 - code 128 12-25
 - UCC/EAN-128 12-26
 - code 39 bar codes
 - buffering 12-36
 - check digit verification 12-33
 - code 39 12-27
 - full ASCII 12-35
 - lengths 12-31
 - transmit check digit 12-34
 - code 93 bar codes
 - code 93 12-40
 - lengths 12-41
 - code identifiers
 - AIM code IDs B-3
 - Symbol code IDs B-1
 - code types
 - ADF 14-12
 - connecting power 1-4

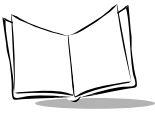

D

decode zone	2-7
default parameters	4-3
IBM 468X/469X	8-3
keyboard wedge	5-3
miscellaneous scanner options	13-3
RS-232	6-3
standard default table	A-1
symbolologies	12-3
USB	7-4
user preferences	4-3
wand emulation	9-3, 10-3
discrete 2 of 5 bar codes	
discrete 2 of 5	12-54
lengths	12-55

H

host types	
keyboard wedge	5-4
RS-232	6-7
wand emulation	9-4

I

IBM 468X/469X connection	8-2
IBM 468X/469X default parameters	8-3
IBM 468X/469X parameters	8-4
interleaved 2 of 5 bar codes	
check digit verification	12-51
convert to EAN-13	12-53
transmit check digit	12-52

K

keyboard wedge connection	5-2
keyboard wedge default parameters	5-3
keyboard wedge parameters	5-4

L

LS	2-7
----	-----

M

maintenance	3-1
miscellaneous scanner parameters	13-3
mounting the stand	2-9
MSI bar codes	
check digit algorithm	12-68
check digits	12-66
lengths	12-64
MSI	12-63
transmit check digit	12-67

N

notational conventions	2-xiii
------------------------	--------

P

parameters	
IBM 468X/469X	8-4
keyboard wedge	5-4
RS-232	6-5
USB	7-5
wand emulation	9-4
parts	2-1
pinouts	
scanner signal descriptions	3-6
power supply	
connecting	1-4

Q

quiet zone (leading margin)	9-5
-----------------------------	-----

R

RS-232 connection	6-2
RS-232 default parameters	6-3
RS-232 parameters	6-5, 6-7
RSS	
Convert RSS to UPC/EAN	12-71

S

scanner defaults	4-3
scanner parts	2-1
scanning	

- aiming 2-6
- errors 4-2, 12-2, 13-2
- hand-held 2-5
- hands-free 2-8, 2-10
- sequence example 4-2, 12-1, 13-2
- security level bar codes
 - bi-directional redundancy 12-77
- service information 2-xiii
- setup
 - connecting a USB interface 7-2
 - connecting an RS-232 interface 6-2
 - connecting interface cable 1-4
 - connecting keyboard wedge interface . 5-2
 - connecting power 1-4
 - connecting power supply 1-4
 - connecting to an IBM 468X/469X host 8-2
 - connecting using wand emulation 9-2, 10-2
 - installing the cable 1-3
 - unpacking 1-2
- signal descriptions 3-6
- specifications 3-4
- stand
 - assembling 2-8
 - mounting 2-9
- standard default parameters A-1
- standard defaults 4-3
- support center 2-xiv
- symbol support centers 2-xiv
- symbology default parameters 12-3

T

- technical specifications 3-4

U

- unpacking 1-2
- UPC/EAN bar codes
 - bookland EAN 12-10
 - check digit 12-14
 - convert UPC-E to UPC-A 12-19
 - convert UPC-E1 to UPC-A 12-20
 - EAN zero extend 12-21
 - UCC coupon extended code 12-24
 - UPC-A preamble 12-16
 - UPC-A/UPC-E 12-7
 - UPC-E preamble 12-17
 - UPC-E1 12-8
- UPC/EANbar codes
 - EAN-13/EAN-8 12-9
- UPC/EAN/JAN bar codes
 - supplementals 12-11
- USB connection 7-2
- USB default parameters 7-4
- USB parameters 7-5
- user preferences parameters 4-3

W

- wand emulation connection 9-2, 10-2
- wand emulation default parameters . 9-3, 10-3
- wand emulation parameters 9-4

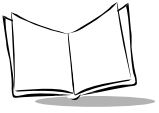

LS 2208 Product Reference Guide

Tell Us What You Think...

We'd like to know what you think about this Guide. Please take a moment to fill out this questionnaire and fax this form to: (631) 738-3318, or mail to:

Symbol Technologies, Inc.
One Symbol Plaza M/S B-4
Holtsville, NY 11742-1300
Attention: Technical Publications Manager

IMPORTANT: If you need product support, please call the appropriate customer support number provided. Unfortunately, we cannot provide customer support at the fax number above.

User's Guide Title: _____
(please include revision level)

How familiar were you with this product before using this guide?

Very familiar Slightly familiar Not at all familiar

Did this guide meet your needs? If not, please explain.

What topics need to be added to the index, if applicable?

What topics do you feel need to be better discussed? Please be specific.

What can we do to further improve our guides?

Thank you for your input—We value your comments.

LS 2208 Product Reference Guide



72-58808-02
Revision A — September 2003