



Gryphon™



Reference Manual

Datalogic Scanning, Inc.
959 Terry Street
Eugene, Oregon 97402
Telephone: (541) 683-5700
Fax: (541) 345-7140

An Unpublished Work - All rights reserved. No part of the contents of this documentation or the procedures described therein may be reproduced or transmitted in any form or by any means without prior written permission of Datalogic Scanning, Inc. or its subsidiaries or affiliates ("Datalogic" or "Datalogic Scanning"). Owners of Datalogic products are hereby granted a non-exclusive, revocable license to reproduce and transmit this documentation for the purchaser's own internal business purposes. Purchaser shall not remove or alter any proprietary notices, including copyright notices, contained in this documentation and shall ensure that all notices appear on any reproductions of the documentation.

Should future revisions of this manual be published, you can acquire printed versions by contacting your Datalogic representative. Electronic versions may either be downloadable from the Datalogic website (www.scanning.datalogic.com) or provided on appropriate media. If you visit our website and would like to make comments or suggestions about this or other Datalogic publications, please let us know via the "Contact Datalogic" page.

Disclaimer

Datalogic has taken reasonable measures to provide information in this manual that is complete and accurate, however, Datalogic reserves the right to change any specification at any time without prior notice. Datalogic is a registered trademark of Datalogic S.p.A. in many countries and the Datalogic logo is a trademark of Datalogic S.p.A. all licensed to Datalogic Scanning, Inc. All other trademarks and trade names referred to herein are property of their respective owners.

CONTENTS

	GENERAL VIEW	viii
1	INTRODUCTION	1
2	INSTALLATION.....	2
2.1	GRYPHON™ D Interface Cable Connections.....	2
2.2	OM-GRYPHON™ Interface Cable Connections	3
2.3	RS232 Connection	4
2.4	USB	4
2.5	IBM USB POS.....	5
2.6	WEDGE Connection	5
2.7	PEN Emulation Connection.....	6
2.8	GRYPHON™ M Battery Maintenance.....	7
2.8.1	Battery Type.....	7
2.8.2	Battery Charging	7
2.8.3	Replacing GRYPHON™ M Batteries	7
3	GRYPHON™ M SYSTEM AND NETWORK LAYOUTS	9
3.1	Stand Alone Layouts	9
3.1.1	Single Reader Layout.....	9
3.1.2	Multiple Reader Layout	9
3.1.3	Multiple Stand Alone Layouts.....	10
3.2	Multidrop STAR-System™ Network Layouts.....	11
3.2.1	Host Master Layout.....	11
4	CONFIGURATION.....	12
4.1	Configuration Methods	12
4.1.1	Reading Configuration Barcodes	12
4.1.2	Using DL Sm@rtSet.....	12
4.1.3	Copy Command	12
4.1.4	Sending Configuration Strings from Host	13
4.2	Setup Procedures	13
4.3	GRYPHON™ D Setup	14
4.4	GRYPHON™ M/OM-GRYPHON™ Stand Alone Setup	14
4.4.1	Using Multiple M-Series Readers With Same Cradle.....	16
4.4.2	GRYPHON™ M/STAR-Modem™ in Stand Alone Mode	17
4.5	GRYPHON™ M/STAR-System™ Setup.....	18
4.6	Interface Selection	20
4.7	USB Reader Configuration.....	25
4.8	Changing Default Settings	28
	RS232 PARAMETERS	29

Baud Rate	30
Parity.....	31
Data Bits	31
Stop Bits.....	32
Handshaking	32
Ack/Nack Protocol.....	33
FIFO.....	33
Inter-character Delay.....	34
Rx Timeout.....	34
Serial Trigger Lock	35
USB PARAMETERS	36
Handshaking	37
Ack/Nack Protocol.....	37
FIFO.....	38
Inter-character Delay.....	38
Rx Timeout.....	39
Serial Trigger Lock	39
Keyboard Nationality	40
FIFO.....	41
Inter-character Delay.....	41
Inter-code Delay.....	42
WEDGE PARAMETERS.....	43
Keyboard Nationality	44
Caps Lock	45
Caps Lock Auto-Recognition (IBM AT compatible only).....	45
Num Lock	46
Inter-character Delay.....	46
Inter-code Delay.....	47
Keyboard Setting.....	48
PEN EMULATION	50
Operating Mode	51
Minimum Output Pulse.....	52
Conversion to Code 39 and Code 128	53
Overflow	54
Output Level.....	54
Idle Level.....	55
Inter-Block Delay.....	55
IBM 46xx	56
IBM Data Formatting	57
DATA FORMAT	58
Code Identifier.....	61

Custom Code Identifier	62
Header	63
Terminator.....	64
Field Adjustment	65
Field Adjustment Character.....	66
Code Length Tx	66
Character Replacement	67
Address Stamping (M Series Only)	69
Address Delimiter (M Series Only).....	69
POWER SAVE.....	70
Scan Rate	71
Sleep State/USB Suspend	71
Enter Sleep Timeout	72
Standby.....	72
READING PARAMETERS.....	73
Operating Mode	74
Hand-Held Operation	74
Stand Operation.....	75
Hardware Trigger Mode	75
Trigger-off Timeout	75
Flash Mode.....	76
Reads per Cycle.....	76
Safety Time.....	77
Beeper Intensity	77
Beeper Tone	78
Beeper Type	78
Beeper Length	78
PDF Decoding Recognition Intensity.....	79
Good Read Spot Duration.....	79
DECODING PARAMETERS.....	80
Ink Spread.....	81
Overflow Control	81
Interdigit Control.....	82
Decoding Safety.....	82
Puzzle Solver™	83
CODE SELECTION	84
EAN/UPC Family	86
2/5 Family	90
Code 39 Family.....	91
Code 128 Family.....	93
Code 93	94
Codabar Family.....	95

MSI	97
Plessey	98
Telepen	99
Delta IBM	100
Code 11	101
Code 16K	102
Code 49	102
PDF417	103
RSS Codes	104

ADVANCED FORMATTING	105
Concatenation	106
Advanced Formatting	109

RADIO PARAMETERS.....	124
Radio Protocol Timeout.....	125
Power-Off Timeout.....	125
Beeper Control for Radio Response	126
Battery Type.....	126
Single Store	127

5 REFERENCES	128
5.1 RS232 Parameters	128
5.1.1 Handshaking	128
5.1.2 ACK/NACK Protocol	129
5.1.3 FIFO.....	130
5.1.4 RX Timeout.....	131
5.2 Pen Parameters	131
5.2.1 Minimum Output Pulse.....	131
5.2.2 Conversion to Code 39 and Code 128	131
5.2.3 Overflow.....	132
5.2.4 Output and Idle Levels	132
5.2.5 Inter-Block Delay.....	133
5.3 IBM 46xx Parameters.....	133
5.3.1 IBM Data Formatting (Transmission Format).....	133
5.4 Data Format	134
5.4.1 Header/Terminator Selection	134
5.4.2 Set Custom Extended Header/Terminator Keys	136
5.4.3 Address Stamping.....	138
5.4.4 Address Delimiter.....	138
5.5 Power Save.....	138
5.5.1 Sleep State/USB Suspend	138
5.5.2 Enter Sleep Timeout	139
5.5.3 Standby.....	139
5.6 Reading Parameters	139
5.6.1 Operating Mode	139

5.6.2	Hardware Trigger Mode	140
5.6.3	Trigger-Off Timeout.....	140
5.6.4	Reads per Cycle.....	140
5.6.5	Safety Time.....	141
5.7	Decoding Parameters	141
5.7.1	Ink-Spread	141
5.7.2	Overflow Control	141
5.7.3	Interdigit Control.....	141
5.8	Radio Parameters (M Series Only).....	142
5.8.1	Radio Protocol Timeout.....	142
5.8.2	Power-Off Timeout.....	142
5.8.3	Beeper Control for Radio Response	142
5.8.4	Single Store	143
5.9	Configuration Editing Commands.....	144
5.10	Configuration Copying Commands	145
5.10.1	Copy GRYPHON™ D-Series.....	145
5.10.2	Copy GRYPHON™ M-Series	146
5.10.3	Copy OM-GRYPHON™	147
5.11	C-GRYPHON™ Configuration	148
5.12	Default Parameters for POS Terminals.....	149
6	TECHNICAL FEATURES	150
6.1	GRYPHON™ D.....	150
6.2	GRYPHON™ M.....	151
6.3	OM-GRYPHON™ / C-GRYPHON™	152
6.4	System and Radio Features.....	153
6.5	Status Indicators	153
6.6	Reading Diagrams	155
A	HOST CONFIGURATION STRINGS.....	157
B	CODE IDENTIFIER TABLE.....	170
C	HEX AND NUMERIC TABLE	173

GENERAL VIEW

GRYPHON™ D/M READERS

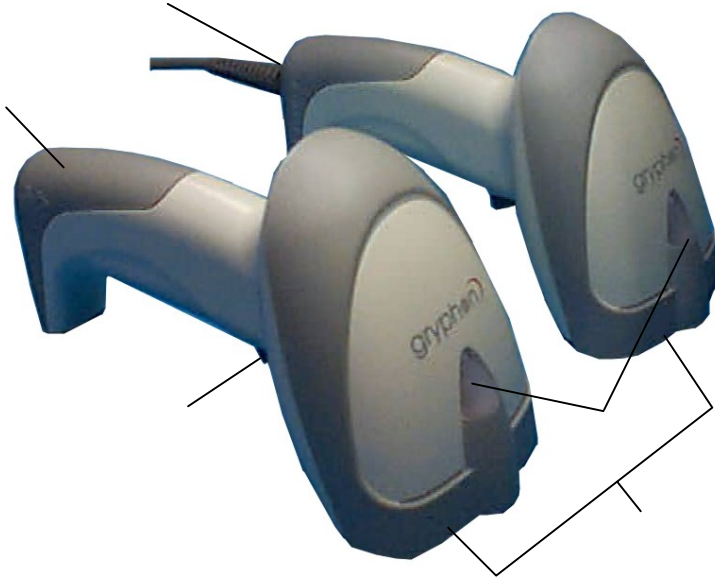

Figure A – Gryphon™ D and M Series Readers

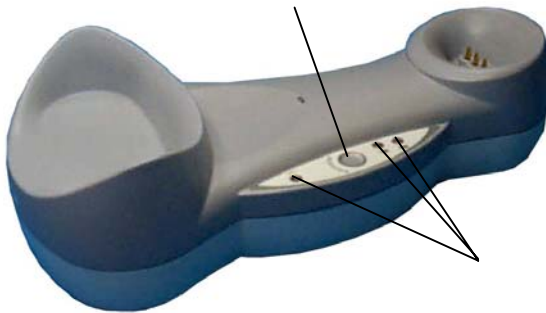

Figure B – OM-GRYPHON™ and C-GRYPHON™

1 INTRODUCTION

Datalogic has moved a step ahead in the concept of “instinctive reading.” The new **Gryphon™** reader has been developed to provide optimised reading performance through excellent ergonomic design, a natural instinctive reading approach and innovative good reading feedback.

The “INSTINCTIVE READING DISTANCE,” a concept introduced by Datalogic a few years ago based on in-depth ergonomic studies, represents the natural position of the user while reading a code. The **Gryphon™** series takes this concept one step further. The series includes two tethered (D100 and D200) and two cordless (M100 and M200) models, allowing operations anywhere mobility is required at the desk/POS and around the shop floor, as well as in a small warehouse. The new “green spot,” (Datalogic patent application) produced by the **Gryphon™** provides “good reading” feedback directly on the code, where the user usually tends to be looking. Correct pointing becomes quick and easy thanks to the sharp and bright illumination line. All these characteristics are coupled with outstanding performance in terms of reading quickness and decoding capability thanks to state-of-the-art optics and a decode rate of 270 scans/sec, making the **Gryphon™** very user friendly, intuitive and fast.

Specially optimised optics allow reading of the most popular standard codes with superior depths of field from near contact to over 30 cm. High resolution codes, which can reach 3 mils are also easily read. Two specific models of the **Gryphon™** series (D200 and M200) have also been designed to provide decoding of the PDF417, as well as traditional barcodes. The **Gryphon™** reader series is paving the road for innovative barcode reading.

2 INSTALLATION



CAUTION

Connections should always be made with power OFF!

2.1 GRYPHON™ D INTERFACE CABLE CONNECTIONS

The Gryphon™ D reader incorporates a multi-standard interface which can be connected to a Host by plugging the correct interface cable into the connector as shown below.



To disconnect the cable, insert a paper clip or other similar object into the slot on the reader battery cover while unplugging the cable from the Gryphon™ D body.



CAUTION

Connections should always be made with power OFF!

2.2 OM-GRYPHON™ INTERFACE CABLE CONNECTIONS

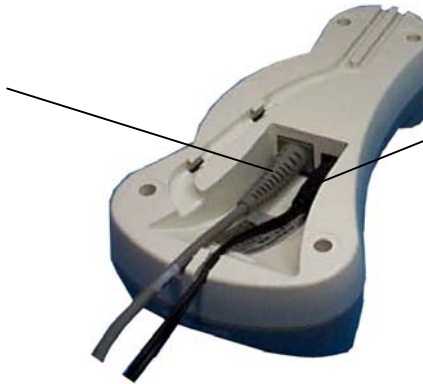

OM-GRYPHON™ Connectors

The OM-GRYPHON™ incorporates a multi-standard interface which can be connected to a Host by simply plugging the correct interface cable into the connector, placed on the base of the cradle. In addition the cradle must be connected to an external power supply.

To disconnect the cable, insert a paper clip or other similar object into the hole corresponding to the Host connector on the body of the cradle.

Push down on the clip while unplugging the cable.



Disconnecting the OM-GRYPHON™ Cable

2.3 RS232 CONNECTION

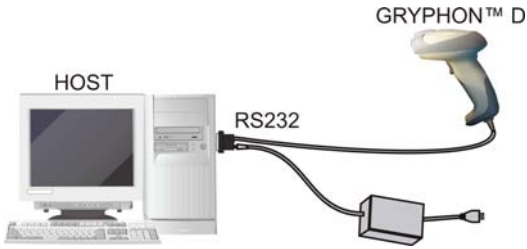

2.4 USB



2.5 IBM USB POS

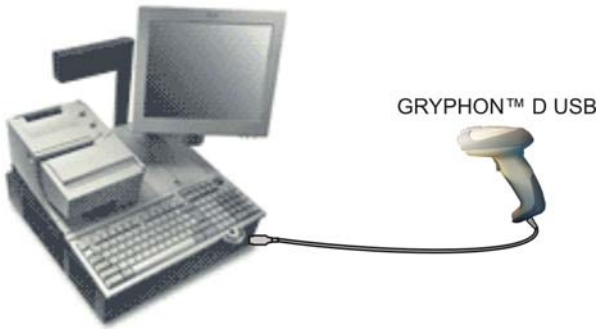

2.6 WEDGE CONNECTION

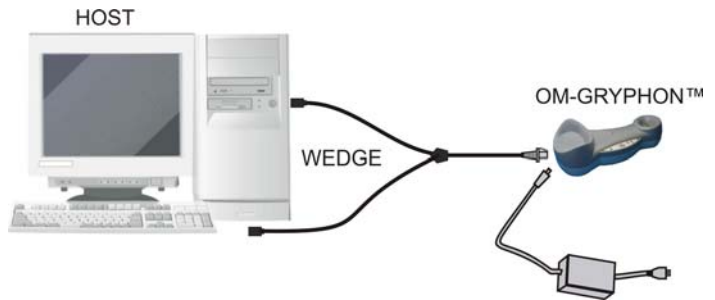

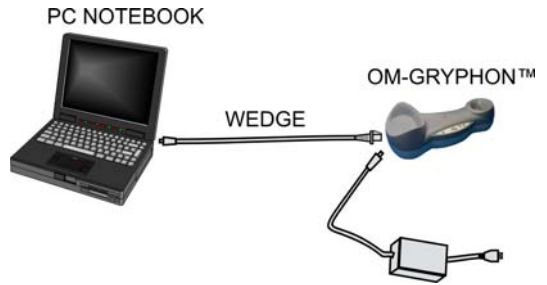
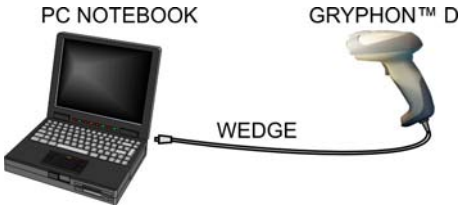

2.7 PEN EMULATION CONNECTION

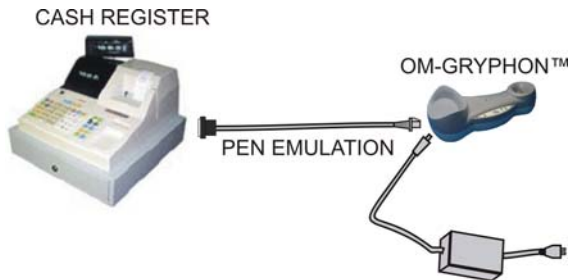
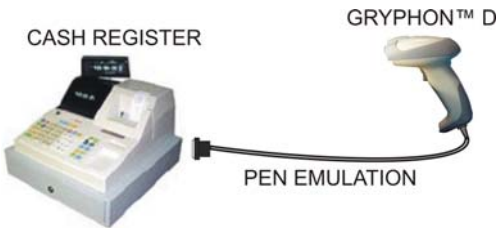

2.8 GRYPHON™ M BATTERY MAINTENANCE

2.8.1 Battery Type

You can install NiMh, NiCd or Alkaline AA batteries in the Gryphon™ M.

2.8.2 Battery Charging

Once the system is connected and powered, you can place the Gryphon™ M into the cradle to charge the battery.

When the scanner is correctly inserted in the cradle, the red LED on the cradle goes on to indicate that the battery is charging. The green LED on the cradle goes on when the battery is completely charged.

When using NiCd or NiMh batteries, frequent recharging before fully discharging can cause a “memory effect” in which the batteries assume a reduced capacity.

Since it is not practical to wait for the reader to be fully discharged before recharging it, the OM-Gryphon™ and the C-Gryphon™ are provided with a battery-reconditioning feature which overcomes the “memory effect” problem.

To perform battery reconditioning, simply press the battery-reconditioning key on the cradle control panel: the battery will be fully discharged in a short period of time (red LED flashing), then automatically recharged.

We recommend performing the battery reconditioning once every few months or whenever you feel the battery capacity has decreased.

2.8.3 Replacing GRYPHON™ M Batteries

To change the batteries in your Gryphon™ M scanner, proceed as follows:

1. Unscrew the battery cover screw.



2. Open the battery cover.



3. Replace the old batteries with new ones, then screw the battery cover back into place.



NiMh, NiCd, or Alkaline AA Batteries



WARNING

Do not incinerate, disassemble, short terminals or expose to high temperature. Risk of fire, explosion. Use specified charger only. Risk of explosion if the battery is replaced by an incorrect type. Dispose of the batteries as required by the relevant laws in force.

3 GRYPHON™ M SYSTEM AND NETWORK LAYOUTS

There are two basic system layouts that can be employed: Stand Alone systems and Multidrop STAR-System™ Networks.

3.1 STAND ALONE LAYOUTS

3.1.1 Single Reader Layout

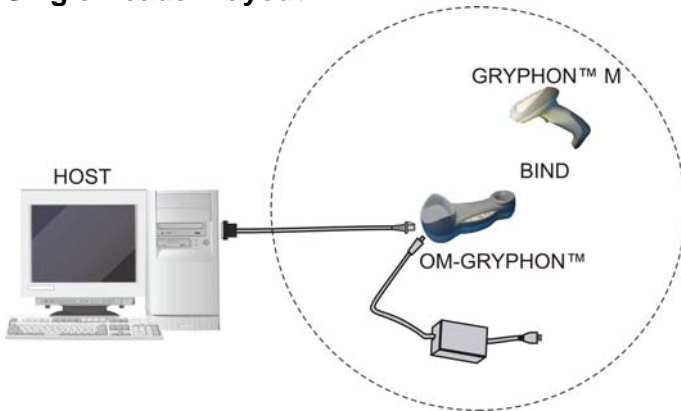

3.1.2 Multiple Reader Layout

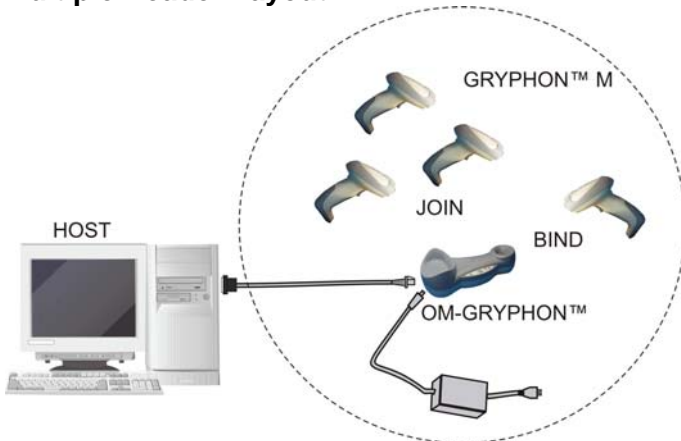

In stand alone systems, each cradle is connected to a single Host.

3.1.3 Multiple Stand Alone Layouts

Many stand alone connections can operate in the same physical area without interference, provided all readers and cradles in the system have different addresses.

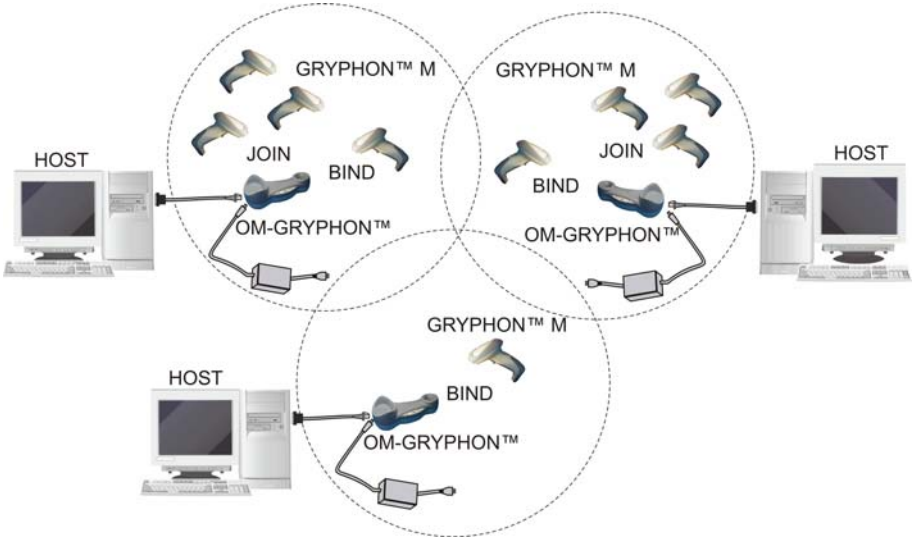

Multiple Stand Alone Systems in the Same Area

Since the cradles can communicate to multiple Gryphon™ M scanners, you might find it useful to employ one or more C-Gryphon™ battery chargers in addition to the OM-Gryphon™ cradle, so that the battery re-charging operation can be performed for several scanners at the same time.

3.2 MULTIDROP STAR-SYSTEM™ NETWORK LAYOUTS

Even though many stand alone systems can operate in the same physical area without interfering with each other, it may be desirable to bridge data from multiple base stations in a network to a single Host. Gryphon™ M readers are compatible with STAR-System™ networks. These networks provide seamless active roaming for any RF reading device in the system.

3.2.1 Host Master Layout

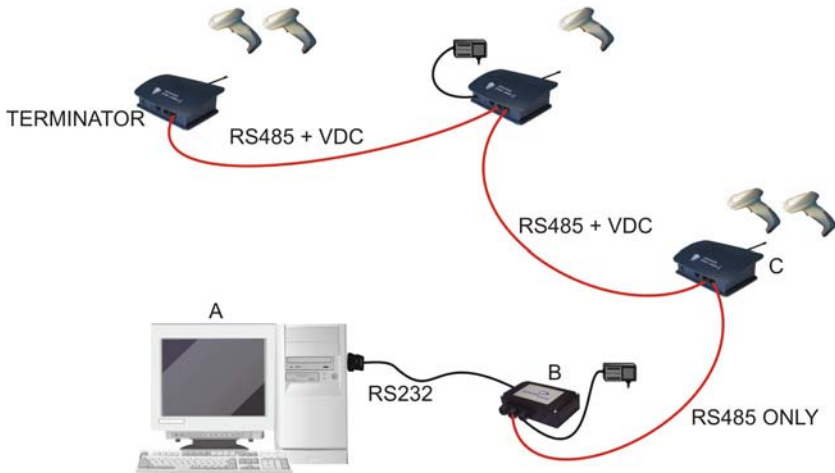

- A. Host Master with STAR-Link™
- B. STAR-Box™ converter
- C. STARGATE™ base stations

Example Multidrop STAR-System™ Network with Host as Master

In this layout the Host acts as the Master using STAR-Link™ software. The Host is connected in RS232 to a STAR-Box™ converter which is connected to the first slave in the RS485 network. In this way the base stations provide communications between a single Host and all readers in the system. STARGATE™ base stations are used as slaves in this network. The Slaves at the ends of the network must be terminated (see the STARGATE™ and STAR-Box™ Installation Manuals).

See par. 4.5 and or the Sm@rtSet Help On-Line for system configuration specifications.

4 CONFIGURATION

4.1 CONFIGURATION METHODS

4.1.1 Reading Configuration Barcodes

This manual can be used for complete setup and configuration of your reader by following the setup procedures in this chapter (see par. 4.2 for an overview).

If you wish to change the default settings, this manual provides complete configuration of your reader in an easy way.

To configure your reader:

- 1) Open the folded page in [Appendix C](#) with the hex-numeric table and keep it open during the device configuration.
- 2) Read the **Enter Configuration** code ONCE, available at the top of each page of configuration.
- 3) Modify the desired parameters in one or more sections following the procedures given for each group.
- 4) Read the **Exit and Save Configuration** code ONCE, available at the top of each page of configuration.

Reference notes describing the operation of the more complex parameters are given in chapter 5.

4.1.2 Using DL Sm@rtSet

DL Sm@rtSet is a Windows-based utility program providing a quick and user-friendly configuration method via the RS232 interface.

It also allows upgrading the software of the connected device (see the DL Sm@rtSet User's Manual for more details).

4.1.3 Copy Command

A previously configured device (Master), can be used to send its configuration directly to other devices of the same type (Slaves). The particular procedure for each device is given in par. 5.10.

4.1.4 Sending Configuration Strings from Host

An alternative configuration method is provided in Appendix A using the RS232 interface. This method is particularly useful when many devices need to be configured with the same settings. Batch files containing the desired parameter settings can be prepared to configure devices quickly and easily.

4.2 SETUP PROCEDURES

For Gryphon™ D-Series readers, follow the setup procedures in pars. 4.3 and 4.6.

For Gryphon™ D USB readers, follow the setup procedures in par. 4.7.

For Gryphon™ M-Series readers, the setup procedures depend on two basic applications, Stand Alone or STAR-System™.

Stand Alone applications allow communication with the Host by either the OM-Gryphon™ cradle (par. 4.4), or by the STAR-Modem™ radio modem (par. 4.4.2).

STAR-System™ applications allow communication with the Host through an RS485 network by the STARGATE™ RF base station or by the STAR-Modem™ radio modem (par. 4.5).

Proceed as shown in the following diagram:

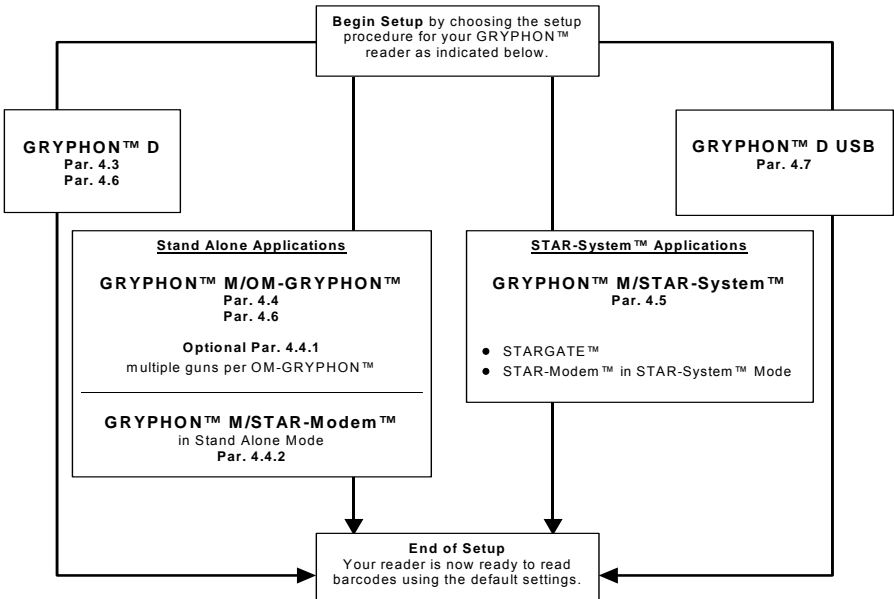

4.3 GRYPHON™ D SETUP

1. Read the restore default parameters code below.

Restore Gryphon™ D Default



After reading the above code, go to par. 4.6 Interface Selection.

4.4 GRYPHON™ M/OM-GRYPHON™ STAND ALONE SETUP

Read the restore default parameters code below.

- 1.

Restore Gryphon™ M Default



2. Read the codes below to set the radio address of the Gryphon™ M reader.

Enter configuration



- 3.

Set Radio Address



+

four digits for the Gryphon™ M Address (from **0000** to **1999**).

All readers used in the same area must have different addresses.

- 4.

Exit and Save configuration



5. Read the **Bind** code to pair the Gryphon™ M to the OM-Gryphon™ cradle. The reader is dedicated to the cradle. Any previously **bound** reader will be excluded.

To connect several readers to the same cradle see the following paragraph 4.4.1, 'Using Multiple M Readers with Same Cradle'.

Bind



The green LED on the Gryphon™ M will blink; the reader is ready to be positioned onto the cradle.

6. Firmly position the reader onto the OM-Gryphon™ cradle within 10 seconds, a beep will be emitted, signaling that the OM-Gryphon™ cradle has been paired to the Gryphon™ M, and the green LED on the reader will go off.

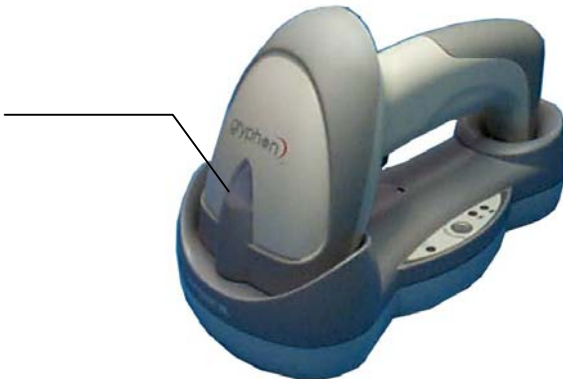

7. Read the OM-Gryphon™ restore default code:

Restore OM-Gryphon™ default



Go to par. 4.6 Interface Selection.

4.4.1 Using Multiple M-Series Readers With Same Cradle

If you want to use several M-Series readers with the same OM-Gryphon™ cradle, you must first **Bind** the cradle with one of the readers (see previously described configuration procedure).

Successive readers can be associated with the same cradle by following the configuration procedure substituting the **Bind** command with **Join** (step 5).

5.



The green LED on the Gryphon™ M will blink: the reader is ready to be positioned onto the cradle. **Complete step 6.**

END of procedure.



CAUTION

*If the cradle is not **Bound** to a reader, its address assumes a random value which can cause conflicts and malfunctions to other cradles within its range.*

YOUR READER IS NOW READY TO READ BARCODES.

To change the defaults see par. 4.8.

4.4.2 GRYPHON™ M/STAR-Modem™ in Stand Alone Mode

To configure a Gryphon™ M reader to communicate with STAR-Modem™ in Stand Alone Mode, follow the procedure in par. 4.4 substituting steps 4 and 5 with those below:

4.

STAR-Modem™ Address



Read the code above and the four-digit address of the STAR-Modem™.

5.

Exit and Save configuration



END of procedure.

YOUR READER IS NOW READY TO READ BARCODES.

To change the defaults see par. 4.8.

4.5 GRYPHON™ M/STAR-SYSTEM™ SETUP

The following procedure allows configuring a Gryphon™ M reader to communicate with various STAR-System™ devices such as STARGATE™ RF base stations.

1. Restore Gryphon™ M Default



2. Enter configuration



3. Set the connection according to the length of the codes to be read:

Code Length \leq 240 Characters



Code Length >240 Characters



4. Set Radio Address



+

four digits from the Numeric Table in the range **0000-1999**.

All readers must have different addresses.

5.

First STAR-System™ Address



Read the code above and the four-digit address of the First STAR-System™ device in the system.

6.

Set Last STAR-System™ Address



Read the code above and the four-digit address of the Last STAR-System™ device in the system.

**NOTE**

Whenever the system is composed of a single base station, the first and last base station addresses (steps 5 and 6) must have the same value.

7.

Exit and Save Configuration

**END of procedure.****YOUR READER IS NOW READY TO READ BARCODES.**

To change the defaults see par. 4.8.

4.6 INTERFACE SELECTION

Read the interface selection code for your application.

RS232

Standard



POS Terminals

Nixdorf Mode A



Fujitsu



ICL Mode



For POS terminal default settings refer to par. 5.12.

PEN



WEDGE

IBM AT or PS/2 PCs



IBM XT



PC Notebook



IBM SURE1



IBM Terminal 3153



WEDGE (CONTINUED)

IBM Terminals 31xx, 32xx, 34xx, 37xx:

To select the interface for these IBM Terminals, read the correct KEY TRANSMISSION code. Select the KEYBOARD TYPE if necessary (default = advanced keyboard).

KEY TRANSMISSION MODE

make-only keyboard



make-break keyboard



KEYBOARD TYPE

◆ advanced keyboard



typewriter keyboard



WEDGE (CONTINUED)

ALT MODE

The ALT-mode selection allows barcodes sent to the PC to be interpreted correctly independently from the Keyboard Nationality used. **You do not need to make a Keyboard Nationality selection.**

(default = Num Lock Unchanged). **Make sure the Num Lock key on your keyboard is ON.**

IBM AT - ALT mode



PC Notebook - ALT mode



WYSE TERMINALS

ANSI Keyboard



PC Keyboard



ASCII Keyboard



VT220 style Keyboard



WEDGE (CONTINUED)

DIGITAL TERMINALS

VT2xx/VT3xx/VT4xx



APPLE

APPLE ADB Bus



IBM 46XX

(IBM 46xx models only)

PORT 9B

4501 Protocol



(typical)

1520 Protocol



PORT 5B

1520 Protocol



(typical)

4501 Protocol



4.7 USB READER CONFIGURATION

The USB interface is compatible with:

Windows 98 (and later)

IBM POS for Windows

Mac OS 8.0 (and later)

4690 Operating System

USB Start-up

As with all USB devices, upon connection, the Host performs several checks by communicating with the USB device. During this phase the green LED on the device blinks and normal operations are suspended. Two basic conditions must be met before the USB device is ready to read codes, the correct USB driver must be loaded and sufficient power must be supplied to the reader.

For all systems, the correct USB driver for the default USB-KBD interface is included in the Host Operating System and will either be loaded automatically or will be suggested by the O.S. and should therefore be selected from the dialog box (the first time only).

If the Host supplies sufficient power to the reader, the start-up phase ends correctly, the LED stops blinking and the reader emits the beep OK signal.

If the Host does not supply sufficient power to the reader, a dialog box will appear on the Host and the reader will be blocked (LED continues blinking). In this case, disconnect the USB device cable at the Host (LED stops blinking), connect and power-up an external supply to the USB cable then reconnect the USB cable to the Host and close the dialog box. The reader emits the beep OK signal. You can now read codes. At this point you can read the USB interface configuration code according to your application. Load drivers from the O.S. (if requested). When configuring the USB-COM interface, the relevant files and drivers must be installed from the USB Device Installation software which can be downloaded from the web page <http://www.scanning.datalogic.com>.

The reader is ready.

First Start-Up

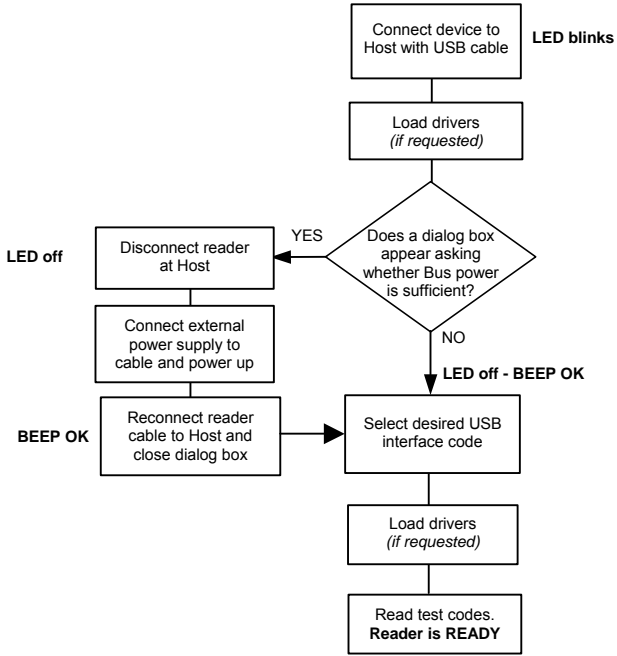

Successive start-ups will automatically recognize the previously loaded drivers. If external power is used, verify that external power is already supplied.

Successive Start-Ups

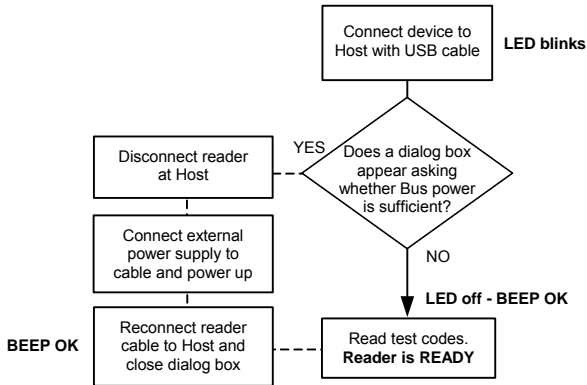

USB

USB-KBD



USB-KBD-ALT-MODE



USB-KBD-APPLE



USB-COM*



USB-IBM-Table Top



USB-IBM-Hand Held



- * When configuring USB-COM, the relevant files and drivers must be installed from the USB Device Installation software which can be downloaded from the web site <http://www.scanning.datalogic.com>.

4.8 CHANGING DEFAULT SETTINGS

Once your reader is setup, you can change the default parameters to meet your application needs. Refer to the preceding paragraphs for initial configuration in order to set the default values and select the interface for your application.

In this manual, the configuration parameters are divided into logical groups making it easy to find the desired function based on its reference group.

The **RS232, WEDGE, PEN EMULATION** groups are for Standard Interface parameter configuration for Gryphon™ D series readers and Gryphon™ M/OM-Gryphon™ Stand Alone configurations only:

The **USB** group is for Gryphon™ D USB only.

The **IBM 46xx** group is for IBM 46xx models only.

The following parameter groups are common to all interface applications:

DATA FORMAT parameters regard the messages sent to the Host system for all interfaces except Pen Emulation.

POWER SAVE manages overall current consumption in the reading device.

READING PARAMETERS control various operating modes and indicator status functioning.

DECODING PARAMETERS maintain correct barcode decoding in certain special reading conditions.

CODE SELECTION parameters allow configuration of a personalized mix of codes, code families and their options.

ADVANCED FORMATTING PARAMETERS allow code concatenation and advanced formatting of messages towards the Host. It cannot be used with Pen Emulation connections.

RADIO PARAMETERS (M series only) allow configuration of radio control parameters.

RS232 PARAMETERS

Gryphon™ D Series Readers
+
Gryphon™ M/OM-Gryphon™ configurations only

⊙	BAUD RATE	⊙
⊙	PARITY	⊙
⊙	DATA BITS	⊙
⊙	STOP BITS	⊙
⊙	HANDSHAKING	⊙
⊙	ACK/NACK PROTOCOL	⊙
⊙	FIFO	⊙
⊙	INTER-CHARACTER DELAY	⊙
⊙	RX TIMEOUT	⊙
⊙	SERIAL TRIGGER LOCK	⊙

1. Read the **Enter Configuration** code ONCE, available at the top of each page.

2. Read configuration codes from the desired groups.



= Read the code and follow the procedure given



= Default value

3. Read the **Exit and Save Configuration** code ONCE, available at the top of each page.



BAUD RATE

150 baud



300 baud



600 baud



1200 baud



2400 baud



4800 baud



◆ 9600 baud



19200 baud



38400 baud





RS232



PARITY

◆ none



even parity



odd parity



DATA BITS

7 bits



◆ 8 bits



9 bits





STOP BITS

◆ 1 stop bit



2 stop bits



HANDSHAKING

◆ disable



hardware (RTS/CTS)



software (XON/XOFF)



RTS always ON



See par. 5.1.1 for details.



ACK/NACK PROTOCOL

◆ disable (sw 3.1.0)



enable (sw 3.1.0)



◆ disable (sw 4.0 and later)



enable (sw 4.0 and later)



See par. 5.1.2 for details, particularly on implementing this parameter with Gryphon™ M.

FIFO

disable



◆ enable



See par. 5.1.3 for details.



INTER-CHARACTER DELAY

delay between characters transmitted to Host



Read 2 numbers from the table where:

00 = DELAY disabled

01-99 = DELAY from 1 to 99 milliseconds

◆ delay disabled

RX TIMEOUT

timeout control in reception from Host



Read 2 numbers from the table where:

00 = TIMEOUT disabled

01-99 = TIMEOUT from .1 to 9.9 seconds

◆ rx timeout 5 seconds

See par. 5.1.4 for details.



SERIAL TRIGGER LOCK

◆ disabled



enable and select characters



Read 2 characters from the Hex/Numeric table in the range 00-FE where:

- First Character enables device trigger
- Second Character inhibits device trigger until the first character is received again.

USB PARAMETERS

⊙	USB-COM	⊙
	Handshaking, Ack/Nack protocol, FIFO, Inter-character delay, Rx timeout, Serial trigger lock	
⊙	USB-KBD	⊙
	Keyboard nationality, FIFO, Inter-character delay, Inter-code delay	
⊙	USB-IBM	⊙
	No parameter selection required.	

1. Read the **Enter Configuration** code ONCE, available at the top of each page.
2. Read configuration codes from the desired groups.



= Read the code and follow the procedure given



= Default value

3. Read the **Exit and Save Configuration** code ONCE, available at the top of each page.



HANDSHAKING

◆ disable



hardware (RTS/CTS)



software (XON/XOFF)



RTS always ON



See par. 5.1.1 for details.

ACK/NACK PROTOCOL

◆ disable



enable



See par. 5.1.2 for details.



FIFO

disable



◆ enable



See par. 5.1.3 for details.

INTER-CHARACTER DELAY

delay between characters transmitted to Host

**Read 2 numbers from the table where:**

00 = DELAY disabled

01-99 = DELAY from 1 to 99 milliseconds

◆ delay disabled



RX TIMEOUT

timeout control in reception from Host



Read 2 numbers from the table where:

00 = TIMEOUT disabled

01-99 = TIMEOUT from .1 to 9.9 seconds

◆ rx timeout 5 seconds

See par. 5.1.4 for details.

SERIAL TRIGGER LOCK

◆ disabled



enable and select characters



Read 2 characters from the Hex/Numeric table in the range 00-FE where:

- First Character enables device trigger
- Second Character inhibits device trigger until the first character is received again.

**USB-KBD*****KEYBOARD NATIONALITY*****Not Available for USB-KBD-ALT-MODE Interface**

This parameter default value is restored through the Interface Selection code and not Restore Default.

Belgian



English



French



German



Italian



Japanese



Spanish



Swedish



◆ USA





FIFO

disable



◆ enable



See par. 5.1.3 for details.

INTER-CHARACTER DELAY

delay between characters transmitted to Host



Read 2 numbers from the table where:

00 = DELAY disabled

01-99 = DELAY from 1 to 99 milliseconds

◆ delay disabled



INTER-CODE DELAY

delay between codes transmitted to Host



Read 2 numbers from the table where:

00 = DELAY disabled
01-99 = DELAY from 1 to 99 seconds

◆ delay disabled



WEDGE PARAMETERS

Gryphon™ D Series Readers
+
Gryphon™ M/OM-Gryphon™ configurations only

⊙	KEYBOARD NATIONALITY	⊙
⊙	CAPS LOCK	⊙
⊙	CAPS LOCK	⊙
⊙	AUTO-RECOGNITION	⊙
⊙	NUM LOCK	⊙
⊙	INTER-CHARACTER DELAY	⊙
⊙	INTER-CODE DELAY	⊙
⊙	KEYBOARD SETTING	⊙

1. Read the **Enter Configuration** code ONCE, available at the top of each page.

2. Read configuration codes from the desired groups.



= Read the code and follow the procedure given



= Default value

3. Read the **Exit and Save Configuration** code ONCE, available at the top of each page.



KEYBOARD NATIONALITY

Belgian



English



French



German



Italian



Spanish



Swedish



◆ USA



The Japanese Keyboard Nationality selection is valid only for IBM AT compatible PCs.

Japanese





CAPS LOCK

◆ caps lock OFF



caps lock ON



Select the appropriate code to match your keyboard caps lock status.

Note: Caps lock manual configuration is ignored when Caps Lock Auto-Recognition is enabled.

For **PC Notebook** interface selections, the caps lock status is automatically recognized, therefore this command is not necessary.

CAPS LOCK AUTO-RECOGNITION (IBM AT COMPATIBLE ONLY)

disable



◆ enable





WEDGE

NUM LOCK

toggle num lock



◆ num lock unchanged



This selection is used together with the Alt Mode interface selection for AT or Notebook PCs.

It changes the way the Alt Mode procedure is executed, therefore it should be set as follows:

- if your keyboard Num Lock is normally on use **num lock unchanged**
- if your keyboard Num Lock is normally off use **toggle num lock**

In this way the device will execute the Alt Mode procedure correctly for your application.

INTER-CHARACTER DELAY

delay between characters transmitted to Host



Read 2 numbers from the table where:

00 = DELAY disabled
 01-99 = DELAY from **1** to **99** milliseconds

◆ delay disabled



INTER-CODE DELAY

delay between codes transmitted to Host



Read 2 numbers from the table where:

00 = DELAY disabled

01-99 = DELAY from **1** to **99** seconds

◆ delay disabled



KEYBOARD SETTING

ALPHANUMERIC KEYBOARD SETTING

The reader can be used with terminals or PCs with various keyboard types and nationalities through a simple keyboard setting procedure.

The type of computer or terminal must be selected before activating the keyboard setting command.

Keyboard setting consists of communicating to the reader how to send data corresponding to the keyboard used in the application. The keys must be set in a specific order.

Press and release a key to set it.

Some characters may require more than one key pressed simultaneously during normal use (refer to the manual of your PC or terminal for keyboard use). The exact sequence must be indicated to the reader in this case pressing and releasing the different keys.

Example:

If one has to press the "Shift" and "4" keys simultaneously on the keyboard to transmit the character "\$" to the video, to set the "\$", press and release "Shift" then press and release "4".

Each pressed and released key must generate an acoustic signal on the reader, otherwise repress the key. Never press more than one key at the same time, even if this corresponds to the normal use of your keyboard.

Press "Backspace" to correct a wrong key entry. In this case the reader emits 2 beeps.

Note: "CAPS LOCK" and "NUM LOCK" must be off before starting the keyboard setting procedure. "SHIFT" must be repressed for each character and cannot be substituted by "CAPS LOCK".

setting the alphanumeric keyboard



Read the code above.

Press the keys shown in the following table according to their numerical order.

Some ASCII characters may be missing as this depends on the type of keyboard: these are generally particular characters relative to the various national symbologies. In this case:

- **The first 4 characters (Shift, Alt, Ctrl, and Backspace) can only be substituted with keys not used, or substituted with each other.**
- characters can be substituted with other single symbols (e.g. "SPACE") even if not included in the barcode set used.
- characters can be substituted with others corresponding to your keyboard.

The reader signals the end of the procedure with 2 beeps indicating the keys have been registered.

WEDGE

01 : Shift		
02 : Alt		
03 : Ctrl		
04 : Backspace		
05 : SPACE	28 : 7	51 : N
06 : !	29 : 8	52 : O
07 : "	30 : 9	53 : P
08 : #	31 : :	54 : Q
09 : \$	32 : ;	55 : R
10 : %	33 : <	56 : S
11 : &	34 : =	57 : T
12 : '	35 : >	58 : U
13 : (36 : ?	59 : V
14 :)	37 : @	60 : W
15 : *	38 : A	61 : X
16 : +	39 : B	62 : Y
17 : ,	40 : C	63 : Z
18 : -	41 : D	64 : [
19 : .	42 : E	65 : \
20 : /	43 : F	66 :]
21 : 0	44 : G	67 : ^
22 : 1	45 : H	68 : _ (underscore)
23 : 2	46 : I	69 : `
24 : 3	47 : J	70 : {
25 : 4	48 : K	71 :
26 : 5	49 : L	72 : }
27 : 6	50 : M	73 : ~
		74 : DEL

GRYPHON™ M-Series Readers Only

When working with Gryphon™ M-Series readers, the keyboard setup functioning is signaled by the LEDs on the OM-Gryphon™ cradle. Each key stroke corresponds to a double blinking of the green LED.

By pressing the Backspace key the red LED on the OM-Gryphon™ cradle blinks, while the green LED stays on.



CAUTION

Do not place the reader onto the OM-GRYPHON™ cradle during this procedure. Otherwise, the battery charging will occur modifying the LEDs functioning.

Once the procedure has been completed, the green LED turns off.

PEN EMULATION

Gryphon™ D Series Readers
+
Gryphon™ M/OM-Gryphon™ configurations only

⊙	OPERATING MODE	⊙
⊙	MINIMUM OUTPUT PULSE	⊙
⊙	CONVERSION TO CODE 39	⊙
⊙	OVERFLOW	⊙
⊙	OUTPUT LEVEL	⊙
⊙	IDLE LEVEL	⊙
⊙	INTER-BLOCK DELAY	⊙

1. Read the **Enter Configuration** code ONCE, available at the top of each page.

2. Read configuration codes from the desired groups.

◆ = Default value

3. Read the **Exit and Save Configuration** code ONCE, available at the top of each page.

PEN EMULATION

The operating mode parameters are complete commands and do not require reading the Enter and Exit configuration codes.

OPERATING MODE

◆ interpret mode



Interprets commands without sending them to the decoder.

transparent mode



Sends commands to the decoder without interpreting them.



MINIMUM OUTPUT PULSE

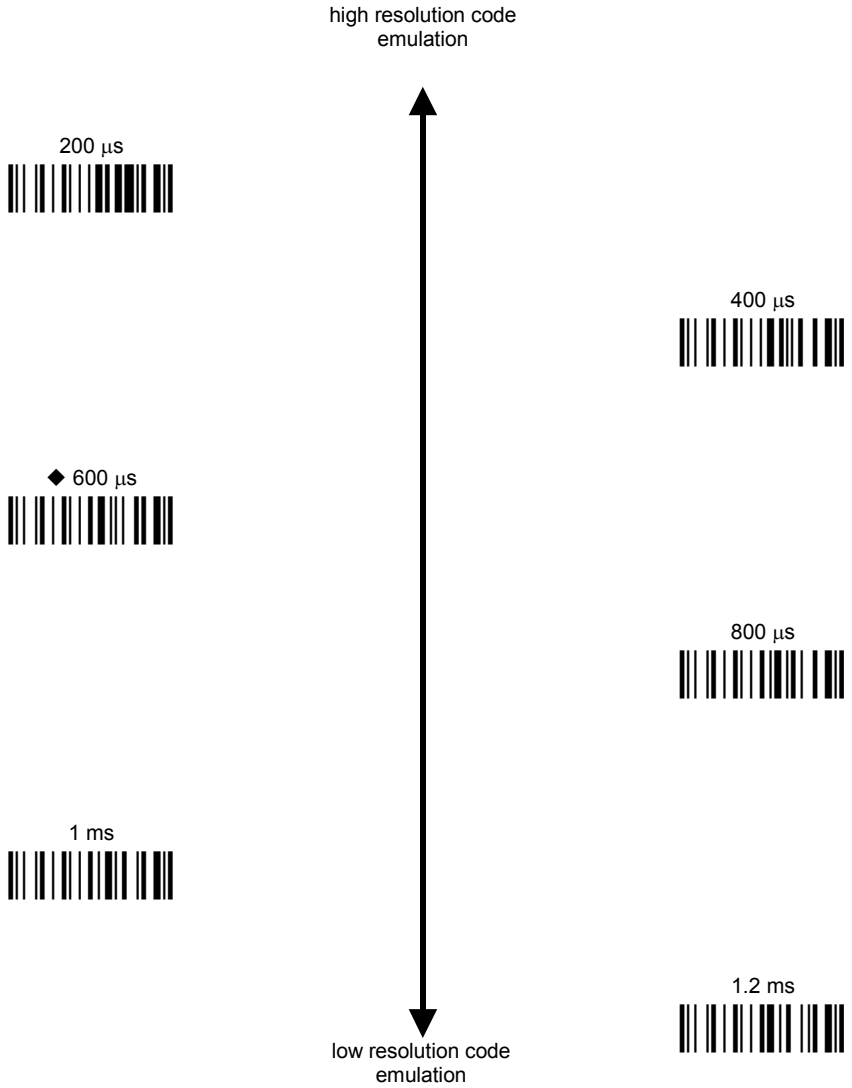

See par. 5.2.1 for details.



CONVERSION TO CODE 39 AND CODE 128

▶ disable conversion to Code 39



Transmits codes in their original format.

□ enable conversion to Code 39



Converts codes read into Code 39 format.

enable conversion to Code 128



Converts codes read into Code 128 format.

▶ = default value for Gryphon™ D Series Readers

□ = default value for Gryphon™ M Series Readers

See par. 5.2.2 for details.



OVERFLOW

narrow



◆ medium



wide



See par. 5.2.3 for details.

OUTPUT LEVEL

◆ normal
(white = logic level 0)



inverted
(white = logic level 1)



See par. 5.2.4 for details.



IDLE LEVEL

◆ normal
(black level)



inverted
(white level)



See par. 5.2.4 for details.

INTER-BLOCK DELAY

delay between character blocks transmitted to Host



Read 2 numbers from the table where:

00 = DELAY disabled
01-99 = DELAY from .1 to 9.9 seconds

◆ delay disabled

See par. 5.2.5 for details.

IBM 46XX

For IBM 46xx Models Only

⊙ *IBM DATA FORMATTING* ⊙

1. Read the **Enter Configuration** code ONCE, available at the top of each page.

2. Read configuration codes from the desired groups.

◆ = Default value

3. Read the **Exit and Save Configuration** code ONCE, available at the top of each page.



IBM DATA FORMATTING

conversion to Code 39



◆ IBM Standard



mixed IBM Standard + Code 39



See par. **5.3.1** for details.

DATA FORMAT

NOT FOR PEN INTERFACES

⊙	CODE IDENTIFIER	⊙
⊙	CUSTOM CODE IDENTIFIER	⊙
⊙	HEADER	⊙
⊙	TERMINATOR	⊙
⊙	FIELD ADJUSTMENT	⊙
⊙	FIELD ADJ. CHARACTER	⊙
⊙	CODE LENGTH TX	⊙
⊙	CHARACTER REPLACEMENT	⊙
⊙	ADDRESS STAMPING	⊙
⊙	ADDRESS DELIMITER	⊙

1. Read the **Enter Configuration** code ONCE, available at the top of each page.

2. Read configuration codes from the desired groups.



= Read the code and follow the procedure given



= Default value

3. Read the **Exit and Save Configuration** code ONCE, available at the top of each page.

DATA FORMAT

CODE IDENTIFIER TABLE			
CODE	AIM STANDARD	DATALOGIC STANDARD	Custom
2/5 interleaved] l y	N	
2/5 industrial] X y	P	
2/5 normal 5 bars] S y	O	
2/5 matrix 3 bars] X y	Q	
EAN 8] E 4	A	
EAN 13] E 0	B	
UPC A] X y	C	
UPC E] X y	D	
EAN 8 with 2 ADD ON] E 5	J	
EAN 8 with 5 ADD ON] E 6	K	
EAN 13 with 2 ADD ON] E 1	L	
EAN 13 with 5 ADD ON] E 2	M	
UPC A with 2 ADD ON] X y	F	
UPC A with 5 ADD ON] X y	G	
UPC E with 2 ADD ON] X y	H	
UPC E with 5 ADD ON] X y	I	
Code 39] A y	V	
Code 39 Full ASCII] A y	W	
CODABAR] F y	R	
ABC CODABAR] X y	S	
Code 128] C y	T	
EAN 128] C y	k	
ISBT 128] C4	f	
Code 93] G y	U	
CIP/39] X y	Y	
CIP/HR] X y	e	
Code 32] X y	X	
MSI] M y	Z	
Plessey Standard] P 0	a	
Plessey Anker] P 1	o	
Telepen] X 0	d	
Delta IBM] X 0	c	
Code 11] H y	b	
Code 16K] K 0	p	
Code 49] T y	q	
RSS Expanded Linear and Stacked] e 0	t	
RSS Limited] e 0	v	
RSS 14 Linear and Stacked] e 0	u	

DATA FORMAT

- AIM standard identifiers are not defined for all codes: the X identifier is assigned to the code for which the standard is not defined. The y value depends on the selected options (check digit tested or not, check digit tx or not, etc.).
- When customizing the Datalogic Standard code identifiers, 1 or 2 identifier characters can be defined for each code type. If only 1 identifier character is required, the second character must be selected as **FF** (disabled).
- The code identifier can be singly disabled for any code by simply selecting **FF** as the first identifier character.
- Write in the Custom character identifiers in the table above for your records.



DATA FORMAT



CODE IDENTIFIER

◆ disable



Datalogic standard



AIM standard



custom





CUSTOM CODE IDENTIFIER

define custom code identifier(s)



- ① Read the above code.
(Code Identifiers default to Datalogic standard, see table on previous page).
- ② Select the code type from the code table in Appendix **B** for the identifier you want to change.
- ③ You can define 1 or 2 identifier characters for each code type. If only 1 identifier character is required, the second character must be selected as **FF** (disabled). Read the hexadecimal value corresponding to the character(s) you want to define as identifiers for the code selected in step ②: valid characters are in the range **00-FD**.

Example: To define Code 39 Code Identifier = @

Read define custom code identifier(s) + Code 39 + 40 + FF



HEADER

no header



one character header



two character header



three character header



four character header



five character header



six character header



seven character header



eight character header



After selecting **one** of the desired Header codes, read the character(s) from the HEX table. Valid characters are in the range **00-FE**.

Example:

four character header

+ 41 + 42 + 43 + 44 = Header **ABCD**

For more details see par. 5.4.1 and par. 5.4.2.



TERMINATOR

no terminator



one character terminator



two character terminator



three character terminator



four character terminator



five character terminator



six character terminator



seven character terminator



eight character terminator



After selecting **one** of the desired Header codes, read the character(s) from the HEX table. Valid characters are in the range **00-FE**.

Example:

two character terminator



+ 0D + 0A = Terminator CR LF

For more details see par. 5.4.1. and par. 5.4.2.

**FIELD ADJUSTMENT**

◆ disable field adjustment



Field adjustment allows a number of characters n , to be added to or subtracted from the barcode read. The adjustment can be different for each enabled code type. To define the field adjustment:

① Read the enable field adjustment code:

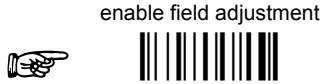
② Select the code type from the Code Identifier Table in Appendix B.

③ Select the type of adjustment to perform:

right addition



left addition



right deletion



left deletion

④ Read a number in the range **01 - 32** from the Hex/Numeric Table to define how many characters to add or delete:**Conditions:**

- Adjustment is only performed on the barcode data, the Code Identifier and Code Length Transmission fields are not modified by the field adjustment parameter.
- If the field setting would subtract more characters than exist in the barcode, the subtraction will take place only to code length 0.
- You can set up to a maximum of 10 different field adjustments on the same barcode family or on different barcode families.

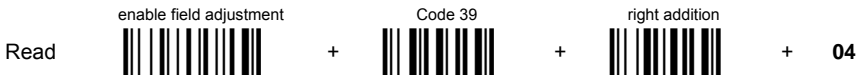
Example: To add 4 characters to the right of Standard Code 39 Codes:



FIELD ADJUSTMENT CHARACTER

- ① Read the field adjustment character code:



field adjustment character



- ② Read the hexadecimal value corresponding to the character you want to use for field adjustment. Valid characters are in the range **00-FE**.

Example:

To define the field adjustment character = **A**:

field adjustment character
Read  + 41

CODE LENGTH TX

◆ code length not transmitted



code length transmitted in variable-digit format



code length transmitted in fixed 4-digit format



The code length is transmitted in the message after the Headers and Code Identifier characters. The code length is calculated after performing any field adjustment operations.



CHARACTER REPLACEMENT

◆ disable character replacement



This parameter allows up to three characters to be replaced from the barcode read. These substitutions are stored in memory. To define each character replacement:

- ① Read one of the following character replacement codes:



first character replacement



second character replacement



third character replacement



- ② From the Code Identifier Table in Appendix **B**, read the Code Identifier for the desired code family.
0 = character replacement will be effective for all code families.
- ③ From the Hex/Numeric Table read two characters corresponding to the Hex value (**00-FE**) which identifies the character to be replaced.
- ④ From the Hex/Numeric Table read two characters corresponding to the Hex value (**00-FE**) which identifies the new character to replace.
FF = the character to be replaced will be substituted with no character, that is, it will be removed from the code.

**Example:**

The following strings define:

1. *First Character Replacement:* substitution in *Code 39 barcodes* of all occurrences of the **0** character with the **1** character.
2. *Second Character Replacement:* substitution in *Code 39 barcodes* of all occurrences of the **A** character with the **B** character.

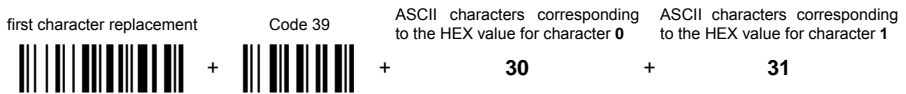

For Code 39 codes containing the string "**0123**", the contents transmitted will be "**1123**".

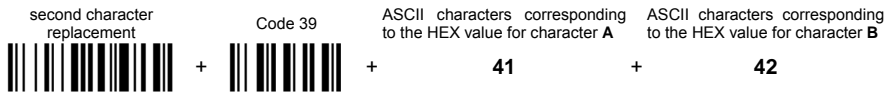

For Code 39 codes containing the string "**ABCD**", the contents transmitted will be "**BBCD**".



ADDRESS STAMPING (M SERIES ONLY)

- ◆ disable reader address stamping



- enable reader address stamping



See par. 5.4.3 for details.

ADDRESS DELIMITER (M SERIES ONLY)

- ◆ disable reader address delimiter



- enable reader address delimiter and select characters



Read 2 HEX characters in the range **00-FE**.

See par. 5.4.4 for details.

POWER SAVE

⊙	SCAN RATE	⊙
⊙	SLEEP STATE/USB SUSPEND	⊙
⊙	ENTER SLEEP TIMEOUT	⊙
⊙	STANDBY	⊙

1. Read the **Enter Configuration** code ONCE, available at the top of each page.

2. Read configuration codes from the desired groups.



= Read the code and follow the procedure given



= Default value

3. Read the **Exit and Save Configuration** code ONCE, available at the top of each page.

**POWER SAVE*****SCAN RATE***

67 scans per sec.



135 scans per sec.



◆ 270 scans per sec.



A lower scan rate reduces power consumption but can lengthen reading response time.

SLEEP STATE/USB SUSPEND

◆ disable



enable



See par. 5.5.1 for details.

For M-Series readers, sleep state is entered immediately after reading a code and is not configurable.



POWER SAVE

ENTER SLEEP TIMEOUT

enter sleep timeout



Read 2 numbers in the range 00-99:

00 = Enter Sleep state immediately

01-99 = corresponds to a max. 9.9 sec. delay before entering the Sleep state.

◆ enter sleep timeout = 0.6 sec.

See par. 5.5.2 for details.

STANDBY

◆ disable



optimize for reading speed

enable



optimize for low power consumption

See par. 5.5.3 for details.

For M-Series readers, standby is always enabled and is not configurable.



READING PARAMETERS

⊙	OPERATING MODE	⊙
⊙	HAND-HELD OPERATION	⊙
⊙	STAND OPERATION	⊙
⊙	HARDWARE TRIGGER MODE	⊙
⊙	TRIGGER-OFF TIMEOUT	⊙
⊙	FLASH MODE	⊙
⊙	READS PER CYCLE	⊙
⊙	SAFETY TIME	⊙
⊙	BEEPER INTENSITY	⊙
⊙	BEEPER TONE	⊙
⊙	BEEPER TYPE	⊙
⊙	BEEPER LENGTH	⊙
⊙	PDF DECODING RECOGNITION INTENSITY	⊙
⊙	GOOD READ SPOT DURATION	⊙

1. Read the **Enter Configuration** code ONCE, available at the top of each page.

2. Read configuration codes from the desired groups.



= Read the code and follow the procedure given



= Default value

3. Read the **Exit and Save Configuration** code ONCE, available at the top of each page.

***OPERATING MODE***

You can pre-configure both Hand-Held and Stand operating modes, and with the codes below, you can switch between them. See par. 5.6.1 for details. Stand operation is not advised for M-Series readers since it constantly consumes battery power.

- ◆ hand-held operation



stand operation



automatic

***HAND-HELD OPERATION***

- ◆ hardware trigger



* always on



- * not available for M-Series readers

software trigger



automatic



hardware trigger ready



**STAND OPERATION**

hardware trigger



software trigger



* always on



* not available for M-Series readers

◆ automatic

**HARDWARE TRIGGER MODE**

◆ trigger active level



trigger active pulse



See par. 5.6.2 for details

TRIGGER-OFF TIMEOUT

trigger-off timeout

**Read 2 numbers in the range 00-99:**

00 = disables the trigger-off timeout

01-99 = corresponds to a max. 99-sec. delay after the trigger press to allow the reader to turn off automatically.

◆ trigger-off timeout disabled

See par. 5.6.3 for details.



READING PARAMETERS

FLASH MODE

"FLASH" ON duration



"FLASH" OFF duration



Read 2 numbers in the range 01-99:

01 to 99 = from .1 to 9.9 seconds.

◆ Flash-ON = 1 sec. Flash-OFF = 0.6 sec

READS PER CYCLE

◆ one read per cycle



multiple reads per cycle



See par. 5.6.4 for details.

***SAFETY TIME***

safety time

Limits same code consecutive reading.**Read 2 numbers in the range 00-99:**

00 = no same code consecutive reading until reader is removed (no decoding) for at least 400 ms.

01-99 = timeout from .1 to 9.9 seconds before a consecutive read on same code.

◆ safety time = 0.5 sec

See par. **5.6.5** for details.***BEEPER INTENSITY***

* very low intensity



low intensity



medium intensity



◆ high intensity



* This sets the beeper OFF for data entry, while for all other beeper signals it has the meaning "very low intensity". The Beeper Intensity parameter is effective for all operating conditions described in par. **6.5**.



READING PARAMETERS



BEEPER TONE

tone 1



◆ tone 2



tone 3



tone 4



BEEPER TYPE

◆ monotone



bitonal



BEEPER LENGTH

long



◆ short





READING PARAMETERS



PDF DECODING RECOGNITION INTENSITY

◆ low



high



GOOD READ SPOT DURATION

disable



short



◆ medium



long



DECODING PARAMETERS

⊙	INK SPREAD	⊙
⊙	OVERFLOW CONTROL	⊙
⊙	INTERDIGIT CONTROL	⊙
⊙	DECODING SAFETY	⊙
⊙	PUZZLE SOLVER™	⊙



CAUTION

Before changing these parameter values read the descriptions in par. 5.7.

- 1.** Read the **Enter Configuration** code ONCE, available at the top of each page.
- 2.** Read configuration codes from the desired groups.
◆ = Default value
- 3.** Read the **Exit and Save Configuration** code ONCE, available at the top of each page.



INK SPREAD

disable



◆ enable



See par. 5.7.1 for details.

OVERFLOW CONTROL

disable



◆ enable



See par. 5.7.2 for details.



DECODING PARAMETERS

INTERDIGIT CONTROL

disable



◆ enable



See par. 5.7.3 for details.

DECODING SAFETY

◆ one read



(decoding safety disabled)

two reads



three reads



four reads



Required number of good reads before accepting code.



PUZZLE SOLVER™

◆ disable



enable



In the case of damaged or poorly printed codes, this parameter allows reading multiple parts of the single code to reconstruct it.

To read codes using this technology, simply move the illuminated bar over the code so that each line of the code is scanned. During this process a series of brief “ticks” indicates that reading is proceeding correctly.

Conditions:

- This parameter is only valid for the following codes:

EAN 8 without Add-on	EAN 13 without Add-on	UPC A without Add-on
Code 128	Code 39	

- For Code 39, Check digit control without transmission is forced.
- PuzzleSolver™ is disabled when code ISBT 128 is enabled.

CODE SELECTION

⊙	EAN/UPC FAMILY	⊙
⊙	2/5 FAMILY	⊙
⊙	CODE 39 FAMILY	⊙
⊙	CODE 128 FAMILY	⊙
⊙	CODABAR FAMILY	⊙
⊙	CODE 93	⊙
⊙	MSI	⊙
⊙	PLESSEY	⊙
⊙	TELEPEN	⊙
⊙	DELTA IBM	⊙
⊙	CODE 11	⊙
⊙	CODE 16K	⊙
⊙	CODE 49	⊙
⊙	PDF417	⊙
	PDF READERS ONLY	
⊙	RSS CODES	⊙

1. Read the **Enter Configuration** code ONCE, available at the top of each page.

2. Read configuration codes from the desired groups.



= Read the code and follow the procedure given



= Default value

3. Read the **Exit and Save Configuration** code ONCE, available at the top of each page.

**CODE SELECTION**

DISABLE ALL CODE FAMILIES

**NOTE**

The reader allows up to 5 code selections. This does not limit the number of CODES enabled to 5, as it depends on the code family.

**SINGLE
SELECTIONS =****Example**

5 code selections:

1. **2/5 Interleaved**
2. **2/5 Industrial**
3. Code 128 + EAN 128
4. Code 39 Full ASCII + Code 32
5. **UPC A/UPC E**

In this section all **SINGLE** code selections are **underlined and in bold**.

**CODE SELECTION**

EAN/UPC FAMILY

disable the family



- ① Read the desired family code

Note:

Since the EAN/UPC without ADD ON code selection is enabled by default, to correctly enable another selection, first disable the family.

EAN 8/EAN 13/UPC A/UPC E with and without ADD ON

WITHOUT ADD ON**◆ EAN 8/EAN 13/UPC A/UPC E****EAN 8/EAN 13****UPC A/UPC E**



CODE SELECTION



WITH ADD ON 2 AND 5

EAN 8/EAN 13/UPC A/UPC E



EAN 8/EAN 13



UPC A/UPC E



WITH ADD ON 2 ONLY

EAN 8/EAN 13



UPC A/UPC E



WITH ADD ON 5 ONLY

EAN 8/EAN 13



UPC A/UPC E





CODE SELECTION

EAN/UPC CHECK DIGIT TX SELECTIONS

For each code type in this family you can choose to transmit the check digit or not

CHECK DIGIT TRANSMISSION

◆ EAN 8



◆ EAN 13



◆ UPC A



◆ UPC E



NO CHECK DIGIT TRANSMISSION

EAN 8



EAN 13



UPC A



UPC E





CODE SELECTION

CONVERSION OPTIONS

UPC E to UPC A conversion



UPC E to EAN 13 conversion



UPC A to EAN 13 conversion



EAN 8 to EAN 13 conversion



Enable only ISBN conversion



Enable only ISSN conversion



Enable both ISBN and ISSN conversion



Disable both ISBN and ISSN conversion



**CODE SELECTION****2/5 FAMILY**

disable the family



① Read the desired family code

◆ **Interleaved 2/5****Normal 2/5 (5 Bars)****Industrial 2/5 (IATA)****Matrix 2/5 (3 Bars)**

The pharmaceutical code below is part of the 2/5 family but has no check digit or code length selections.

Code CIP/HR

French pharmaceutical code

② Read a check digit selection

CHECK DIGIT TABLE

no check digit control



◆ check digit control and transmission



check digit control without transmission



③ Read 4 numbers for the code length where:

- **First 2 digits** = minimum code length.
- **Second 2 digits** = maximum code length.

The maximum code length is **99** characters.

The minimum code length must always be less than or equal to the maximum.

Examples:

0199 = variable from 1 to 99 digits in the code.

1010 = 10 digit code length only.



CODE SELECTION

CODE 39 FAMILY

disables the family



① Read the desired family code

② Read a check digit selection

CHECK DIGIT TABLE

◆ **Standard Code 39**



◆ **no check digit control**



Full ASCII Code 39



check digit control
and transmission



check digit control
without transmission





CODE SELECTION

The pharmaceutical codes below are part of the Code 39 family but have no check digit selections.

Code CIP39



French pharmaceutical code

Code 32



Italian pharmaceutical code

CODE LENGTH (optional)

The code length selection is valid for the entire Code 39 family

Read the code + 4 numbers for the code length where:

First 2 digits = minimum code length.

Second 2 digits = maximum code length.

set code length



The maximum code length is **99** characters.

The minimum code length must always be less than or equal to the maximum.

Examples: **0199** = variable from 1 to 99 digits in the code. **1010** = 10 digit code length only.



CODE SELECTION

CODE 128 FAMILY

disables the family



- ① Read the desired family code

◆ Code 128



control without transmission
of check digit

EAN 128



control without transmission
of check digit

Transmit GS Before Code

Code EAN 128 uses the ASCII <GS> character to separate a variable length code field from the next code field. This character can also be transmitted before the code.

◆ disable



enable



If the <GS> character has been modified in the Character Replacement parameter, the new character is affected by this command.



CODE SELECTION

ISBT 128



Enabling ISBT 128 automatically disables Puzzle Solver™.

CODE LENGTH (optional)

The code length selection is valid for the entire Code 128 family.

Read the code + 4 numbers for the code length where:

First 2 digits = minimum code length

Second 2 digits = maximum code length

set code length



The maximum code length is 99 characters. The minimum code length must always be less than or equal to the maximum.

Examples: **0199** = variable from 1 to 99 digits in the code. **1010** = 10 digit code length only.

The length is calculated on the output string.

CODE 93

◆ disables the code



Code 93



control without transmission
of check digit



CODE SELECTION

CODABAR FAMILY

◆ disable the family



① Read the desired equality control code

② Read a start/stop transmission selection

Standard Codabar



no start/stop character equality control

START/STOP CHARACTER TRANSMISSION

no transmission



Standard Codabar



start/stop character equality control

transmission



The Codabar ABC code below uses a fixed start/stop character transmission selection.

Codabar ABC



no start/stop character equality control but transmission.



CODE SELECTION

Codabar ABC Forced Concatenation

enable Codabar ABC with forced concatenation



non start/stop character equality control but transmission

CODE LENGTH (optional)

The code length selection is valid for the entire Codabar family

Read the code + 4 numbers for the code length where:

First 2 digits = minimum code length.

Second 2 digits = maximum code length.

set code length



The maximum code length is **99** characters.

The minimum code length must always be less than or equal to the maximum.

Examples: **0199** = variable from 1 to 99 digits in the code. **1010** = 10 digit code length only.

START/STOP CHARACTER CASE IN TRANSMISSION

The start/stop character case selections below are valid for the entire Codabar family:

transmit start/stop characters in lower case



transmit start/stop characters in upper case





CODE SELECTION

MSI

◆ disable the family



Enable the code by selecting one of the check digit selections.

no check digit control



MOD10 check digit control
no check digit transmission



MOD10 check digit control
check digit transmission



MOD11 - MOD10 check digit control
no check digit transmission



MOD11 - MOD10 check digit control
check digit transmission



MOD10 - MOD10 check digit control
no check digit transmission



MOD10 - MOD10 check digit control
check digit transmission





CODE SELECTION

PLESSEY

◆ disable the family



Enable the code by selecting one of the check digit selections.

Standard Plessey

no check digit control



check digit control
check digit transmitted



check digit control
check digit not transmitted



Anker Plessey

no check digit control



check digit control
check digit transmitted



check digit control
check digit not transmitted





CODE SELECTION

TELEPEN

◆ disable the family



Enable the code by selecting one of the check digit selections.

Numeric Telepen

no check digit control



check digit control
check digit transmitted



check digit control
check digit not transmitted



Alphanumeric Telepen

no check digit control



check digit control
check digit transmitted



check digit control
check digit not transmitted





CODE SELECTION



DELTA IBM

◆ disable the family



Enable the code by selecting one of the check digit selections.

no check digit control



Type 1 check digit control



Type 2 check digit control





CODE SELECTION

CODE 11

◆ disable the family



Enable the code by selecting one of the check digit selections.

no check digit control



Type C check digit control
check digit transmitted



Type C check digit control
check digit not transmitted



Type K check digit control
check digit transmitted



Type K check digit control
check digit not transmitted



Type C and Type K
check digit control
check digits transmitted



Type C and Type K
check digit control
check digits not transmitted





CODE SELECTION

CODE 16K

◆ disable the code



Code 16K



To read stacked codes, simply move the reader over the code so that each line of the code is scanned. During this process a series of brief “ticks” indicates that reading is proceeding correctly.

CODE 49

◆ disable the code



Code 49



To read stacked codes, simply move the reader over the code so that each line of the code is scanned. During this process a series of brief “ticks” indicates that reading is proceeding correctly.



CODE SELECTION



PDF417

Only PDF417 readers

disable the code



◆ PDF417



To read stacked codes, simply move the reader over the code so that each line of the code is scanned. During this process a series of brief “ticks” indicates that reading is proceeding correctly.



CODE SELECTION

RSS CODES

◆ disable the family



DISABLE CODE

disable RSS Expanded Linear and Stacked



disable RSS Limited



disable RSS 14 Linear and Stacked



ENABLE CODE

enable RSS Expanded Linear and Stacked



enable RSS Limited



enable RSS 14 Linear and Stacked



To read stacked codes, simply move the reader over the code so that each line of the code is scanned. During this process a series of brief "ticks" indicates that reading is proceeding correctly.



CODE SELECTION

ADVANCED FORMATTING

NOT FOR PEN INTERFACES

- | | | |
|---|----------------------------|---|
| ⊙ | CONCATENATION | ⊙ |
| ⊙ | ADVANCED FORMATTING | ⊙ |



NOTE

Please follow the setup procedure carefully for these parameters.



NOTE

The Advanced Formatting parameters may not be compatible with the IBM USB POS/IBM 46xx interface selection.

- 1.** Read the **Enter Configuration** code ONCE, available at the top of page .
- 2.** Read configuration codes precisely following the numbered procedure given.
 -  = Read the code and follow the procedure given
 - ◆ = Default value
- 3.** Read the **Exit and Save Configuration** code ONCE, available at the top of page.



CONCATENATION

◆ disable



enable



Permits the concatenation of two codes defined by code type and length. It is possible to set a timeout for the second code reading and to define code transmission if the timeout expires.

The order of transmission is CODE 1-CODE 2.

Define Concatenation

1

Code 1

code ID



Read the code type from the Code Identifier Table beginning in Appendix B.

code length



Read a number in the range **01-99** from the Hex/Numeric Table.

ADVANCED FORMATTING



2

Code 2

code ID



Read the code type from the Code Identifier Table beginning in Appendix B.

code length



Read a number in the range **01-99** from the Hex/Numeric Table.

3

Concatenation Result Code ID

use code 1 ID



use code 2 ID



Since you can concatenate codes from different families, you must select the Code ID character of the resulting code. The Code ID character will be sent in the output message only if it is enabled according to the Code Identifier selection (Datalogic, AIM, or Custom).

4

Concatenation Timeout

timeout



Read two numbers in the range **00 to 99**

00= no timeout

01-99 = timeout from 1 to 99 seconds

Define the timeout, which determines the valid waiting period between the two codes, in order to accept concatenation. If the timeout expires, the resulting action will be based on the following selection.

ADVANCED FORMATTING



5

Transmission after Timeout

no code transmitted
after timeout



only code 1 transmitted
(if read) after timeout



only code 2 transmitted
(if read) after timeout



either code 1 or code 2 transmitted
after timeout



ADVANCED FORMATTING

ADVANCED FORMATTING

Advanced formatting has been designed to offer you complete flexibility in changing the format of barcode data **before** transmitting it to the host system. This formatting will be performed when the barcode data meets certain criteria which you will define in the following procedure.

Up to 4 advanced code management formats can be defined and saved in memory. For each format you must complete the entire configuration procedure:

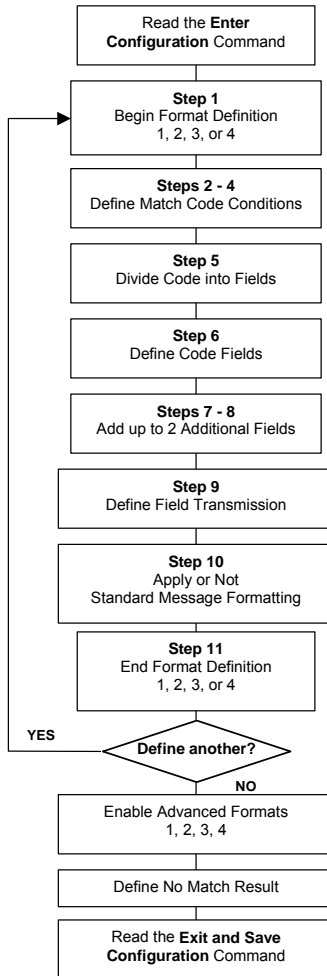

**ADVANCED FORMATTING**

1

Begin Format Definition

begin Format 1 definition



begin Format 2 definition



begin Format 3 definition



begin Format 4 definition



2

Match Code Type

match code type

Read the above code + the code type to match from the [Code Identifier Table](#) in Appendix B.**OR**

any code type



3

Match Code Length

match code length

Read the above code + two numbers in the range **01** to **99** for the exact code length.**OR**

any code length



ADVANCED FORMATTING



4

Match with Predefined Characters

no match



OR

match with 1 character



match with a 2-character string



match with a 3-character string



match with a 4-character string



After selecting the predefined match code, read the character(s) from the HEX table. Range of characters = **01-FE**.

Example:

Match code with the 2-character predefined string = "@@".

Read  + 40 + 40

AND

position of first character in predefined string



Read the above code + two numbers in the range **01** to **99** representing the character position in the code where the first character of the predefined string must be found.

Read **00** if the match string can be found in any character position.

ADVANCED FORMATTING



5

Divide Code into Fields



divide code into fields



Read one number in the range 1 to 5 to divide the code into fields.

6

Define Code Fields

define code fields

Each code field length can be set by either:

- a) defining a field separator character to be found in the code itself. In this case you can choose to **discard** the code separator character or **include** it as the last character of the field.

OR BY

- b) specifying a specific character length up to the maximum of 99 characters.

OR BY

- c) selecting the last field as variable length (if any).

You must define the same number of fields as selected in step 5, including fields that will not be transmitted.

ADVANCED FORMATTING





DEFINE FIELD 1 BY: EITHER

a)  field separator



Read the field separator character from the HEX table. Range of characters = **01-FE**.

discard separator  include separator 

OR

b)  field length



Read two numbers in the range **01** to **99** to define the field length.

OR

c)  this is the last field (variable length)



AND

Field 1 Terminators

no field terminators



1 field terminator



2 field terminators



Read the field terminator character(s) from the HEX table.



Valid range of characters for all readers = **01-FE**.

For readers using Wedge interface, all values from **9C** to **FE** send the Space character.



ADVANCED FORMATTING





DEFINE FIELD 2 BY: EITHER

a)  field separator

Read the field separator character from the HEX table. Range of characters = **01-FE**.

discard separator  include separator 

OR

b)  field length

Read two numbers in the range **01** to **99** to define the field length.

OR

c)  this is the last field (variable length)

AND

Field 2 Terminators

no field terminators



1 field terminator



2 field terminators



Read the field terminator character(s) from the HEX table.



Valid range of characters for all readers = **01-FE**.

For readers using Wedge interface, all values from **9C** to **FE** send the Space character.



ADVANCED FORMATTING





DEFINE FIELD 3 BY: EITHER

a)  field separator

Read the field separator character from the HEX table. Range of characters = **01-FE**.

discard separator  include separator 

OR

b)  field length

Read two numbers in the range **01** to **99** to define the field length.

OR

c)  this is the last field (variable length)

AND

Field 3 Terminators

no field terminators



1 field terminator



2 field terminators



Read the field terminator character(s) from the HEX table.

Valid range of characters for all readers = **01-FE**.

For readers using Wedge interface, all values from **9C** to **FE** send the Space character.

ADVANCED FORMATTING



DEFINE FIELD 4 BY: EITHER

a) 

field separator



Read the field separator character from the HEX table. Range of characters = **01-FE**.

discard separator



include separator



OR

b) 

field length



Read two numbers in the range **01** to **99** to define the field length.

OR

c) 

this is the last field (variable length)



AND

Field 4 Terminators

no field terminators



1 field terminator



2 field terminators



Read the field terminator character(s) from the HEX table.

Valid range of characters for all readers = **01-FE**.

For readers using Wedge interface, all values from **9C** to **FE** send the Space character.

ADVANCED FORMATTING





DEFINE FIELD 5 BY: EITHER

a)  field separator



Read the field separator character from the HEX table. Range of characters = **01-FE**.

discard separator  include separator 

OR

b)  field length



Read two numbers in the range **01** to **99** to define the field length.

OR

c)  this is the last field (variable length)



AND

Field 5 Terminators

no field terminators



1 field terminator



2 field terminators



Read the field terminator character(s) from the HEX table.

Valid range of characters for all readers = **01-FE**.

For readers using Wedge interface, all values from **9C** to **FE** send the Space character.

ADVANCED FORMATTING



7

First Additional Fixed Field

no fixed field



1 character fixed field



2 character fixed field



3 character fixed field



4 character fixed field



5 character fixed field



6 character fixed field



After selecting **one** of the Additional Fixed Field codes, read the corresponding character(s) from the HEX table. Range of characters = **01-FE**. For readers using Wedge interface, all values from **9C** to **FE** send the Space character.

Example:

4 Character Fixed Field

 $+ 4D + 41 + 49 + 4E = \text{MAIN}$

ADVANCED FORMATTING



8

Second Additional Fixed Field

no fixed field



1 character fixed field



2 character fixed field



3 character fixed field



4 character fixed field



5 character fixed field



6 character fixed field



After selecting **one** of the Additional Fixed Field codes, read the corresponding character(s) from the HEX table. Range of characters = **01-FE**. For readers using Wedge interface, all values from **9C** to **FE** send the Space character.

Example:

3 Character Fixed Field

 $+ 53 + 45 + 54 = \text{SET}$

ADVANCED FORMATTING



9

Field Transmission

number of fields to transmit



Read one number in the range **1** to **7** for the number of fields to transmit. **Include only fields to be transmitted.**

Field Order Transmission

Read the codes corresponding to the fields to transmit in the order in which they are to be transmitted. A field can be transmitted more than once. See example.

field 1



field 2



field 3



field 4



field 5



additional field 1



additional field 2



Example:

The barcode is divided into 3 defined fields plus 1 additional fixed field.
Transmit in the order: Field 2, Additional Field 1, Field 1, Field 2.

Number of Fields



ADVANCED FORMATTING



10**Standard Formatting**

do not apply standard formatting



apply standard formatting



After performing Advanced Formatting on the barcode read, Standard Formatting (Headers, Code Length, Code ID, Terminators) can be applied to the message to be transmitted.

11**End Format Definition**

end Format 1 definition



end Format 2 definition



end Format 3 definition



end Format 4 definition





ADVANCED FORMATTING

Enable Advanced Format

◆ no Advanced Formats enabled



enable



Advanced Format 1

disable



enable



Advanced Format 2

disable



enable



Advanced Format 3

disable



enable



Advanced Format 4

disable





ADVANCED FORMATTING



No Match Result

clear data - no transmission



transmit data using standard format



This selection determines the action to be taken when codes read do not conform to the advanced format requisites (no match).

- Codes not matching can be ignored, cleared from memory and not transmitted.
- Codes not matching can be transmitted using the Standard formatting (Headers, Code Length, Code ID, Terminators).

RADIO PARAMETERS

Gryphon™ M Series Readers only

⊙	<i>RADIO PROTOCOL TIMEOUT</i>	⊙
⊙	<i>POWER-OFF TIMEOUT</i>	⊙
⊙	<i>BEEPER CONTROL FOR RADIO RESPONSE</i>	⊙
⊙	<i>BATTERY TYPE</i>	⊙
⊙	<i>SINGLE STORE</i>	⊙

- 1.** Read the **Enter Configuration** code ONCE, available at the top of each page.
- 2.** Read configuration codes from the desired groups.
 = Read the code and follow the procedure given
- 3.** Read the **Exit and Save Configuration** code ONCE, available at the top of each page.



RADIO PARAMETERS

RADIO PROTOCOL TIMEOUT

radio protocol timeout



Read a number from the table where:

02-19 = timeout from **2** to **19** seconds

◆ 2 seconds

See par. **5.8.1** for details.

POWER-OFF TIMEOUT

power-off timeout



Read 2 numbers in the range 00-99:

00 = Power-off disabled; reader always ready

01-99 = corresponds to a max. 99 hour delay before power-off.

◆ power-off after 4 hours.

See par. **5.8.2** for details.



RADIO PARAMETERS

BEEPER CONTROL FOR RADIO RESPONSE

◆ normal



only good decode



only good reception



off



See par. 5.8.3 for details.

BATTERY TYPE

OM-GRYPHON™ CRADLE ONLY

◆ NiMh/NiCD



alkaline





RADIO PARAMETERS



SINGLE STORE

◆ disable



one attempt



two attempts



three attempts



four attempts



five attempts



six attempts



seven attempts



eight attempts



nine attempts



See par. 5.8.4 for details

5 REFERENCES

5.1 RS232 PARAMETERS

5.1.1 Handshaking

Hardware handshaking: (RTS/CTS)

The RTS line is activated by the decoder before transmitting a character. Transmission is possible only if the CTS line (controlled by the Host) is active.

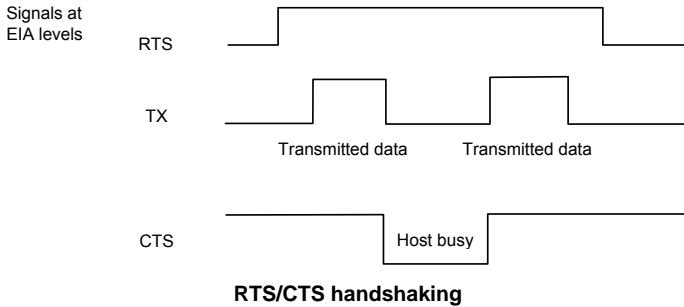

Software handshaking: (XON/XOFF)

During transmission, if the Host sends the XOFF character (13 Hex), the decoder interrupts the transmission with a maximum delay of one character and only resumes when the XON character (11 Hex) is received.

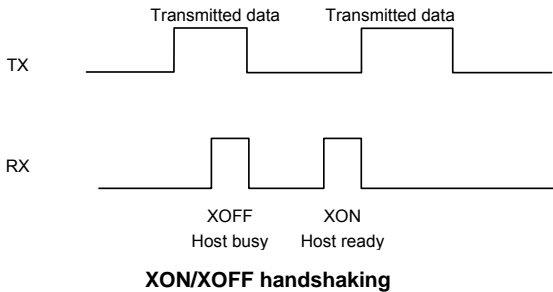

5.1.2 ACK/NACK Protocol

GRYPHON™ D Series Readers

This parameter sets a transmission protocol in which the Host responds to the reader after every code transmitted. The Host sends an ACK character (06 HEX) in the case of good reception or the NACK character (15 HEX) requesting re-transmission, in the case of bad reception.

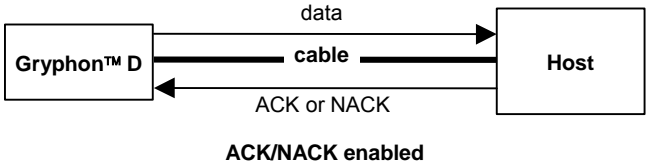

If the reader does not receive an ACK or NACK, transmission is ended after the RX Timeout (see par. 5.1.4).

Selection of the ACK/NACK protocol temporarily disables FIFO buffering see par. 5.1.3.

GRYPHON™ M Series Readers

The transmission protocol takes place between reader, cradle and Host. The reader passes its data (code read) to the cradle which sends it to the Host.

In the following descriptions the completed transmission is indicated by the Beeper Control for Radio Response parameter with its default setting to Normal, see par. 5.8.3.

When ACK/NACK is disabled, there is no control from cradle to Host transmission, the reader responds with the good reception tone.

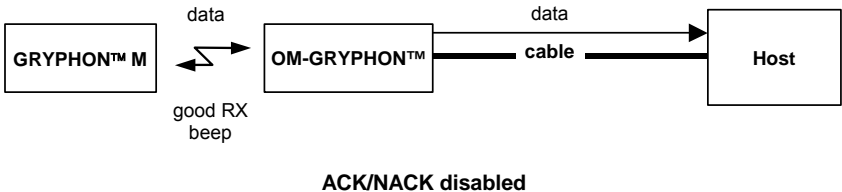

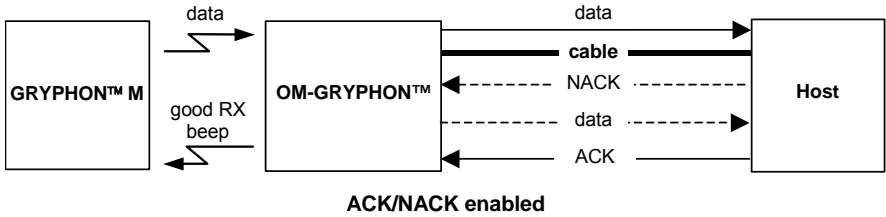

When ACK/NACK is enabled, the Host sends an ACK character (06 HEX) in the case of good reception or the NACK character (15 HEX) requesting re-transmission, in the case of bad reception. Only after the ACK character is received by the OM-Gryphon™ does the reader respond with the good reception tone.

If the reader does not receive an ACK or NACK, transmission is ended after the RX Timeout (see par. 5.1.4). See also Radio Protocol Timeout, par. 5.8.1 for M-Series readers.

Selection of the ACK/NACK protocol temporarily disables FIFO buffering see par. 5.1.3.

5.1.3 FIFO

GRYPHON™ D Series Readers

This parameter determines whether data (barcodes) are buffered on a First In First Out basis allowing faster data collection in certain cases for example when using slow baud rates and/or hardware handshaking.

If the FIFO buffering is enabled, codes are collected and sent out on the serial line in the order of acquisition. About 800 characters can be collected (buffer full), after which the reader signals an error and discards any further codes until the transmission is restored.

If the FIFO buffering is disabled, each code must be transmitted before another one can be read.

GRYPHON™ M Series Readers

If enabled, the OM-Gryphon™ collects all messages sent by Gryphon™ M and sends them in order of acquisition to the connected Host.

If disabled, Gryphon™ M blocks message transmission until the OM-Gryphon™ has completed transmission towards the Host.

5.1.4 RX Timeout

When the RS232 interface is selected, the Host can be used to configure the device by sending it command strings (see Appendix A).

This parameter can be used to automatically end data reception from the Host after the specified period of time.

If no character is received from the Host, after the timeout expires, any incomplete string (any string not terminated by <CR>) is flushed from the device buffer.

5.2 PEN PARAMETERS

5.2.1 Minimum Output Pulse

This parameter sets the duration of the output pulse corresponding to the narrowest element in the barcode. In this way the code resolution is controlled by the signal sent to the decoder, independently of the physical resolution of the code read.

The shortest pulse (200 μ s) corresponds to a high resolution code emulation and therefore a shorter transfer speed to the decoder (for decoders able to work on high resolution codes). Likewise, longer pulses correspond to low resolution code emulation and therefore a longer transfer time to the decoder.

5.2.2 Conversion to Code 39 and Code 128

GRYPHON™ D Series Readers

When using these readers it is possible to convert all codes to Code 39. By disabling this option the decoded codes will be transmitted in their original format; except for the following codes which are ALWAYS converted into Code 39 format: MSI, Plessey, Telepen, Delta IBM, Code 11, Code 16K, Code 49, PDF417, RSS.

GRYPHON™ M Series Readers

When using these readers it is possible to choose between converting the decoded codes into either Code 39 format or Code 128 format. It is not possible to disable conversion.

5.2.3 Overflow

This parameter generates a white space before the first bar and after the last bar of the code. The selections are as follows:

- narrow = space 10 times the minimum output pulse.
- medium = space 20 times the minimum output pulse.
- wide = space 30 times the minimum output pulse.

5.2.4 Output and Idle Levels

The following state diagrams describe the different output and idle level combinations for Pen emulation:

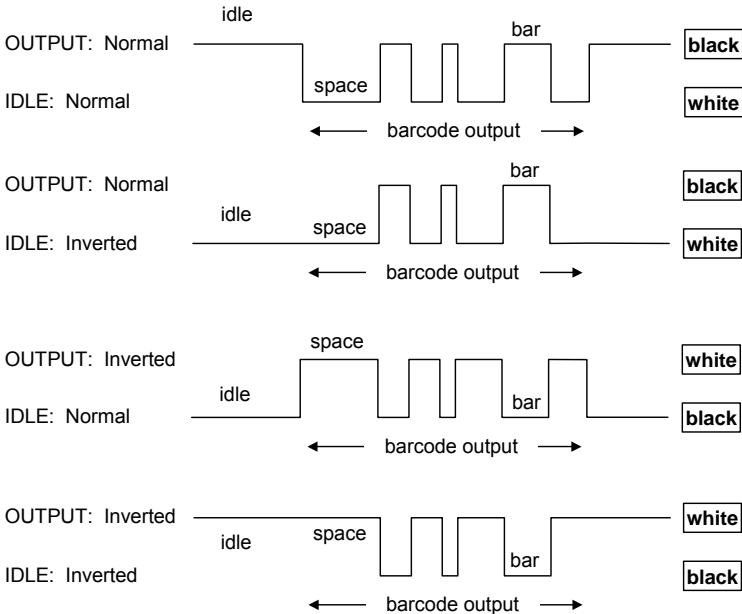

Output and Idle Levels

5.2.5 Inter-Block Delay

For the PEN Emulation interface, data are sent to the Host in fixed size blocks of 20 characters each. The inter-block delay parameter allows setting a delay between each block sent to the Host.

5.3 IBM 46XX PARAMETERS

5.3.1 IBM Data Formatting (Transmission Format)

The IBM 46xx series cash register recognizes the following codes:

- EAN 8/ EAN 13 / UPC A / UPC E with and without Add On
- Interleaved 2/5
- Code 39
- Codabar
- Code 128
- Code 93
- Normal 2/5

The transmission format of codes belonging to this set is specified by the protocol. As the reader allows a wider set of codes to be selected, the following formats are defined to offer the user all the reading possibilities of the Datalogic products.

Conversion to Code 39 Format

Data from any code selected may be transmitted. Each code is transmitted to the Host as Code 39. Any character not included in the standard Code 39 set will be replaced with a "Space" (20 Hex).

IBM Standard Format

Only codes belonging to the above mentioned set may be transmitted. Each code transmitted to the Host is recognized by the identifier requested by the protocol. If the selected code does not belong to this set, it will not be transmitted.

Mixed IBM Standard + Code 39 Format

Data from any code selected may be transmitted. For codes belonging to the above mentioned set, the "IBM Standard Format" is applied. The "Code 39" format applies to codes not belonging to this set.

5.4 DATA FORMAT

The system always provides gun to host data communication using the following message formatting:

Output Message from Gryphon™ D or Gryphon™ M Stand Alone Towards Host
[Header] [Gun_Addr] [Gun_Addr_delimiter] [Code ID] [Code Length] CODE [Terminator]

[Items in square brackets are optional.]

Output Message from Gryphon™ M STAR-System™ Towards Host

[Header] [Code ID] [Code Length] CODE [Terminator]

[Items in square brackets are optional.]

5.4.1 Header/Terminator Selection

The header/terminator selection is not effected by the reading of the restore default code. In fact, header and terminator default values depend on the interface selection:

RS232: no header, terminator CR-LF

WEDGE: no header, terminator ENTER

These default values are always restored through the reading of RS232 or WEDGE interface selection code, see chapter 2.

For the WEDGE interface, the following extended keyboard values can also be configured:

EXTENDED KEYBOARD TO HEX CONVERSION TABLE				
	IBM AT IBM 3153 APPLE ADB	IBM XT	IBM 31xx, 32xx, 34xx, 37xx	Wyse Digital
HEX	KEY	KEY	KEY	KEY
83	ENTER	ENTER	FIELD EXIT	RETURN
84	TAB	TAB	TAB	TAB
85	F1	F1	F1	F1
86	F2	F2	F2	F2
87	F3	F3	F3	F3
88	F4	F4	F4	F4
89	F5	F5	F5	F5
8A	F6	F6	F6	F6
8B	F7	F7	F7	F7
8C	F8	F8	F8	F8
8D	F9	F9	F9	F9
8E	F10	F10	F10	F10
8F	F11	ESC	F11	F11
90	F12	BACKSPACE	F12	F12
91	HOME	HOME	ENTER	F13
92	END	END	RESET	F14
93	PG UP	PG UP	INSERT	F15
94	PG DOWN	PG DOWN	DELETE	F16
95	↑	↑	FIELD -	UP
96	↓	↓	FIELD +	DOWN
97	←	←	ENTER (Paddle)	LEFT
98	→	→	PRINT	RIGHT
99	ESC	ESC		ESC
9A	CTRL (Right)	CTRL (Right)		CTRL (Right)
9B	Euro	Space	Space	Space

For all readers using Wedge interface, all values from **9C** to **FE** send the Space character.



5.4.2 Set Custom Extended Header/Terminator Keys

The extended Header/Terminator keys for **Wedge Interface users** can be customized by defining them through a simple keyboard setting procedure.

For example, the Numeric Keypad keys can be set for use as Headers or Terminators by substituting the default extended keys using this procedure.

The type of computer or terminal must be selected before activating the keyboard setting command.

Press and release a key to set it.

Some characters may require more than one key pressed simultaneously during normal use (refer to the manual of your PC or terminal for keyboard use). The exact sequence must be indicated to the reader in this case pressing and releasing the different keys.

Example:

If one has to press the "Shift" and "4" keys simultaneously on the keyboard to transmit the character "\$" to the video, to set the "\$", press and release "Shift" then press and release "4".

Each pressed and released key must generate an acoustic signal on the reader, otherwise repress the key. Never press more than one key at the same time, even if this corresponds to the normal use of your keyboard.

Press "Back space" to correct a wrong key entry. In this case the reader emits 2 beeps.

Note: "CAPS LOCK" and "NUM LOCK" must be off before starting the keyboard setting procedure. "SHIFT" must be repressed for each character and cannot be substituted by "CAPS LOCK".

Set Custom Extended Header/Terminator Keys



Read the code above.

- **If the first 4 KEYS (Shift, Alt, Ctrl, and Backspace) are not available on your keyboard, you can only substitute them with keys not used, or substitute them with each other.**
- Keys 5 to 28 must be defined

Press the desired keys in the following order:

The reader signals the end of the procedure with 2 beeps indicating the keys have been registered.

CUSTOM EXTENDED KEYBOARD SETTING TABLE		
		Custom
Order	HEX	KEY
01	-	Shift
02	-	Alt
03	-	Ctrl
04	-	Backspace
05	83	
06	84	
07	85	
08	86	
09	87	
10	88	
11	89	
12	8A	
13	8B	
14	8C	
15	8D	
16	8E	
17	8F	
18	90	
19	91	
20	92	
21	93	
22	94	
23	95	
24	96	
25	97	
26	98	
27	99	
28	9A	

GRYPHON™ M Series Readers Only

When working with Gryphon™ M-Series readers, the keyboard setup functioning is signaled by the LEDs on the OM-Gryphon™ cradle. Each key stroke corresponds to a double blinking of the green LED.

By pressing the Backspace key the red LED on the OM-GRYPHON™ cradle blinks, while the green LED stays on.



CAUTION

Do not place the reader onto the OM-Gryphon™ cradle during this procedure. Otherwise, the battery charging will occur modifying the LEDs functioning.

Once the procedure has been completed, the green LED turns off.

5.4.3 Address Stamping

It is possible to include the reader address in the message sent to the host. The reader Address Stamping parameter consists of a 4-digit number in the range 0000-1999.

For message output format, refer to par. 5.4.

5.4.4 Address Delimiter

The Address Delimiter allows a character to be included to separate the reader Address stamping field from the next field in the message. Any character can be included in the hexadecimal range from 00 to FE.

For message output format, refer to par. 5.4.

5.5 POWER SAVE

5.5.1 Sleep State/USB Suspend

When using interfaces other than USB, this mode allows the μ P in the reader to enter a "Sleep" state for minimum power consumption. For D-series readers, this command is only valid when hardware trigger type is selected.

Before entering Sleep mode, the following are verified:

- no commands coming from Host
- no data being transmitted to Host
- Enter Sleep Timeout ended (see par. 5.5.2)

To exit Sleep mode press the trigger.

Enabling the Sleep state implements Standby mode for CCD devices, see par. 5.5.3.

For M-Series readers, sleep state is entered immediately after reading a code and is not configurable. To exit Sleep mode press the trigger.

When using the USB interface, this mode allows the device to manage Selective Suspend conditions generated by the Host Operating System in which optimizing low power consumption (ex. Windows Stand-by). It is possible to exit the Suspend mode either from the Host (ex. moving the mouse during Stand-by) or through the barcode reader. The latter, called Remote Wakeup, makes the device wake up the Host restoring the communication. Remote Wakeup is possible by pressing the trigger.

5.5.2 Enter Sleep Timeout

For readers that have the Sleep state enabled, this timeout determines when the reader will enter this state.

5.5.3 Standby

If this command is enabled, part of the CCD circuitry shuts down (Standby), in order to optimize low power consumption when not reading. When the trigger is pressed this circuitry powers up. This mode causes a minor delay of about 100 ms before the reader is ready.

For M-Series readers, standby is always enabled and is not configurable. To exit Standby press the trigger.

5.6 READING PARAMETERS

5.6.1 Operating Mode

This group of parameters allows setting different reading modes for either Hand-Held operation or Stand operation:

- **Software Trigger:** the reader is set in FLASH MODE. Code reading takes place during the *flash on* time;
- **Hardware Trigger:** the code reading is started with a trigger press (ON);
- **Hardware Trigger Ready:** the illuminator is switched ON when the reader sees a code. It functions as a pointer aiming at the code to be read. The reading phase starts only when the trigger is pressed. In this mode the reader is automatically set to **trigger active level** and **one read per cycle** parameters. (Only for Hand-Held operation);
- **Automatic:** the illuminator is switched ON when the reader sees a code. The reading phase starts automatically;
- **Always ON:** the illuminator is always ON and the reader always ready for code reading. This value is not available for M-Series readers.

5.6.2 Hardware Trigger Mode

This mode determines how the reading phase is controlled when the hardware trigger operating mode is selected:

- trigger active level: the reader goes ON when the trigger is pressed and goes OFF when it is released;
- trigger active pulse: the reader goes ON at the first trigger press and goes OFF only at a second press.

5.6.3 Trigger-Off Timeout

When this timeout is selected, the reader turns OFF automatically after the desired period of time.

5.6.4 Reads per Cycle

In general, a **reading cycle** corresponds to the ON + OFF times of a device. The resulting effects of this parameter on code reading depend on other related configuration conditions. Here are the definitions of ON and OFF times.

- For readers using the software trigger parameter (FLASH MODE), a reading cycle corresponds to the *flash on* + *flash off* times. Code reading takes place during the *flash on* time.
- For readers using the *hardware trigger* parameter, a reading cycle corresponds to a trigger press (ON) + one of the following OFF events:
 - trigger release (for *trigger active level*)
 - a second trigger press (for *trigger active pulse*)
 - trigger-off timeout* (see par. 5.6.3).

When **one read per cycle** is selected, the device decodes only one code during the ON period and immediately turns the reader OFF. It is only possible to read another code when the next ON time occurs.

In **multiple reads per cycle**, the ON period is extended so that the device can continue decoding codes until an OFF event occurs. For software trigger mode, the *flash on* period is immediately reset after each read and therefore extended. If another code is decoded before the reset *flash on* period expires, it is again reset and the effect is that the device remains ON, decoding codes until the *flash on* or *timeout* period expires.

The Safety Time parameter should be used in this case to avoid unwanted multiple reading of the same code, see par. 5.6.5.

5.6.5 Safety Time

Safety time prevents the device from immediately decoding the same code more than once. Same code consecutive reading can be disabled requiring the reader to be removed from the code (no decoding) for at least 400 ms, or a timeout can be set up to 9.9 seconds before the decoder will accept the same code. Reading is immediate if the code changes.

The safety time parameter is not applicable when reading stacked codes or when setting one read per cycle in hardware trigger operating mode, since these settings require voluntary action by the user.

5.7 DECODING PARAMETERS



CAUTION

These parameters are intended to enhance the decoding capability of the reader for particular applications. Used incorrectly, they can degrade the reading performance or increase the possibility of a decoding error.

5.7.1 Ink-Spread

The ink-spread parameter allows the decoding of codes which are not perfectly printed because the page texture tends to absorb the ink.

5.7.2 Overflow Control

The overflow control parameter can be disabled when decoding codes printed on small surfaces, which do not allow the use of an overflow space.

This command does not effect code families 2/5, Code 128 and Code 93.

This command is forced (enabled) when PDF417 codes are enabled.

5.7.3 Interdigit Control

The interdigit control parameter verifies the interdigit spacing for code families Code 39 and Codabar.

5.8 RADIO PARAMETERS (M SERIES ONLY)

5.8.1 Radio Protocol Timeout

This parameter sets the valid time to wait before transmission between the M reader and OM-Gryphon™ cradle is considered failed.

This parameter should be set taking into consideration the radio traffic (number of readers in the same area).

If the RS232 interface is used with ACK/NACK enabled, this parameter should be at least equal to the RX Timeout parameter for low traffic environments. It should be increased if there are many readers in the same area.

It can be set between 2 and 19 seconds.

5.8.2 Power-Off Timeout

If this command is enabled, after the desired timeout in hours, the Gryphon™ batteries are disconnected and all power consumption ceases. To restore power, press the trigger once. The reader will now be ready to read codes.

Power-off does not effect configuration parameters.

5.8.3 Beeper Control for Radio Response

For M-Series readers, the data entry good read tone normally results in two beeps; the first indicates that the reader has decoded the code, the second indicates whether

OM-Gryphon™ has received the data.

This can be changed according to the following selections:

- ◆ Normal: both good decode and good reception are signaled (two beeps).
- ◆ Only Good Decode: only the first beep indicating a good read is signaled.
- ◆ Only Good Reception: only the second beep indicating a good reception is signaled.
- ◆ Off: Neither good read nor good reception beeps are signaled.

For all configurations, any transmission errors will always be signaled.

5.8.4 Single Store







When single store mode is enabled, if the Gryphon™ M fails to transmit a code to the cradle, it enters a special operating mode that prevents the user from reading barcodes. When such operating mode is entered, the trigger no longer enables barcode reading but is used to retry transmission itself for the number of attempts selected in configuration. Once the transmission is successful the reader returns to the standard mode. If transmission is not successful after the number of configured attempts, the code is discarded.

Single store may be useful if you often read codes at the limit of the coverage area and there is a chance that code transmission can fail. In such case single store allows you to move to a more favorable position or location (i.e. closer to the cradle) and retry transmission without the necessity of re-reading the code since it is already stored in the reader.

Conversely, if single store is disabled, and the user wants to retry transmission, the code must be read again, and therefore the attempt must be made from basically the same location. If the user gives up, he does not know if the transaction was successful. (Actually the transmission could have been successful but the cradle may have been unable to acknowledge the message). There are applications in which there is no risk of transmission failure. In such cases it may be better to disable single store so that the user perceives a more consistent behavior of the trigger in that it always corresponds to code reading.

5.9 CONFIGURATION EDITING COMMANDS

The following commands carry out their specific function and then exit the configuration environment.

Command	Description
	Restore Gryphon™ reader default configuration (see the relative Quick Reference Manual for default settings).
	Transmit the Gryphon™ D or Gryphon™ M Software release.
	Transmit Gryphon™ reader configuration in ASCII format. This command is not effective with Pen emulation interface or with the Gryphon™ D200 reader model.
	Restore OM-Gryphon™ default configuration (see the relative Quick Reference Manual for default settings).
	Transmit the OM-Gryphon™ Software release.
	Transmit OM-Gryphon™ configuration in ASCII format. This command is not effective with Pen emulation interface.

5.10 CONFIGURATION COPYING COMMANDS

5.10.1 Copy GRYPHON™ D-Series

Procedure:

- ① Connect the **master** (correctly configured reader) and the **slave** (reader to be configured) together through two RS232 serial interface cables and external power supply. Accessory cables and power supply are available from your Datalogic distributor to provide this connection.

RS232 Cables: CAB363 & CAB364 or CAB320 & CAB328

Power Supply: PG5

- ② Using the **slave** reader, read the Restore Default barcode and then the RS232 interface barcode from chapter 4 of this manual or from the Quick Reference Manual.
- ③ With the **master** reader, read the Configuration Copy barcode below.

Copy Configuration



The configuration will be copied from the master to the slave reader. The slave reader signals the end of the procedure with a series of beeps.

Note: The master reader can be configured for any interface.

5.10.2 Copy GRYPHON™ M-Series

Procedure:

- ① Using the **slave** reader and its OM-Gryphon™ cradle, follow the initialization procedure in chapter 4 of this manual or from the Quick Reference Manual.
- ② With the **master** Gryphon™ M (correctly configured reader), read the Copy Configuration barcode below. Then place it onto an OM-Gryphon™ cradle within 10 seconds. The reader will beep indicating the configuration has been copied.

The configuration will be simultaneously sent over the RS232 interface of the OM-Gryphon™. If this causes undesired effects disconnect the RS232 cable between the PC and OM-Gryphon™ during this process.

Copy Configuration



- ③ With the **slave** Gryphon™ M, read the Get Configuration barcode below. Then place it onto the **same** OM-Gryphon™ cradle used in the step above. The slave reader's address will not be changed.

Get Configuration



The configuration will be copied from the master to the slave Gryphon™ M. The slave Gryphon™ M signals the end of the procedure with a series of beeps. It is now ready to be used with its own OM-Gryphon™ cradle.

- ④ Repeat the procedure above to configure other slave readers. The OM-Gryphon™ can continue to configure slave readers until it receives another command or data.

5.10.3 Copy OM-GRYPHON™

Procedure:

- ① Using the **slave** reader and its OM-Gryphon™ cradle, read the Restore Default barcode, set the radio address, and then read the RS232 interface barcode from chapter 4 of this manual or from the Quick Reference Manual.

- ② Connect the **master** OM-Gryphon™ and the **slave** OM-Gryphon™ (cradle to be configured) together through two RS232 serial interface cables and external power supply. Accessory cables and power supply are available from your Datalogic distributor to provide this connection.

RS232 Cables: CAB363 & CAB364 or CAB320 & CAB328

Power Supply: PG12

- ③ Read the Configuration Copy barcode below with a reader. Then place it onto the **master** OM-Gryphon™ cradle.

Copy Configuration



The configuration will be copied from the master OM-Gryphon™ to the slave OM-Gryphon™. The reader signals the end of the procedure with a series of beeps.

- ④ Repeat the procedure above to configure other slave cradles.

Note: The master OM-Gryphon™ can be configured for any interface.

5.11 C-GRYPHON™ CONFIGURATION

Battery selection is required only when the Gryphon™ M reader has an Alkaline battery and you want to use C-Gryphon™ either for serial configuration, software upgrades or to hold Gryphon™ M. Since this type of battery must not be charged it is necessary to disable the C-Gryphon™ charge function by following the procedure:

1. With the Gryphon™ M read the following code:



The green LED on the Gryphon™ M will blink, signaling the reader has accepted the command.

2. Place the reader onto the charger within 10 seconds. The green LED turns off and a short beep is emitted

To enable the charge function repeat step 1 and 2 substituting the "Alkaline" code with the following one:



CAUTION

Attempts to charge Alkaline batteries could cause leakage of liquid, generation of heat or, in extreme cases, explosion. If using Alkaline batteries, carefully follow the procedure above to avoid damage.

5.12 DEFAULT PARAMETERS FOR POS TERMINALS

The default values of the RS232 and Data Format parameters for POS terminals are listed in the following table:

	NIXDORF Mode A	FUJITSU	ICL Mode
RS232 Group			
Baud Rate	9600	9600	9600
Parity	Odd	None	Even
Data Bits	8	8	8
Stop Bits	1	1	1
Handshaking	Hardware (RTS/CTS)	None	RTS always ON
ACK/NACK Protocol	Disabled	Disabled	Disabled
FIFO	Disabled	Enabled	Enabled
Inter-Character Delay	Disabled	Disabled	Disabled
RX Timeout	9.9 sec	2 sec	9.9 sec
Serial Trigger Lock	Disabled	Disabled	Disabled
Data Format Group			
Code Identifier	Custom	Custom	Custom
Header	No Header	No Header	No Header
Terminator	CR	CR	CR
Field Adjustment	Disabled	Disabled	Disabled
Code Length TX	Not Transmitted	Not Transmitted	Not Transmitted
Character Replacement	Disabled	Disabled	Disabled
Address Stamping	Disabled	Disabled	Disabled
Address Delimiter	Disabled	Disabled	Disabled

The table below lists all the Code Identifiers available for the POS terminals:

CODE	NIXDORF Mode A	FUJITSU	ICL Mode
UPC-A	A0	A	A
UPC-E	C0	E	E
EAN-8	B	FF	FF
EAN-13	A	F	F
Code 39	M	None	C [code length]
Codabar	N	None	N [code length]
Code 128	K	None	L [code length]
Interleaved 2 of 5	I	None	I [code length]
Code 93	L	None	None
Industrial 2 of 5	H	None	H [code length]
UCC/EAN 128	P	None	L [code length]
MSI/Plessey	O	None	None
RSS	E	None	None
PDF417	Q	None	None
Other	None	None	None

6 TECHNICAL FEATURES

6.1 GRYPHON™ D

Electrical Features	
Supply Voltage	5 Vdc ± 5%
Consumption	
Maximum	330 mA
Operating	250 mA
Sleep Mode/USB Suspend	<500 µA
Optical Features	
Sensor	CCD solid state (3648 pixels)
Scan Rate (max)	270 scans/sec
Reading field	see reading diagram (par. 6.6)
Resolution (max)	0.076 mm (3 mils)
PCS (min) (Datalogic Test Chart)	15%
Environmental Features	
Working Temperature	0° to +55 °C / +32° to +131 °F
Storage Temperature	-20° to +70 °C / -4° to +158 °F
Humidity	90% non condensing
Drop resistance	IEC 68-2-32 Test ED
Protection Class	IP30
Mechanical Features	
Weight (without cable)	about 200 g. (7 oz.)
Dimensions	179 x 81 x 98 mm / 7.04 x 3.18 x 3.85 in
Material	ABS and Polycarbonate molded with rubber

6.2 GRYPHON™ M

Electrical Features	
Battery Type	2 AA NiMh* batteries 1.2 V – 1400 mAh
Time of recharge NiMh	From 3 to 5 hours
Operating autonomy (typ. continuous reading)	25,000 reads - NiMh
Indicators	LED, Good Read Spot, Beeper
Optical Features	
Sensor	CCD solid state (3648 pixels)
Scan Rate (max)	270 scans/sec
Reading field	see reading diagram (par. 6.6)
Resolution (max)	0.076 mm (3 mils)
PCS (min) (Datalogic Test Chart)	15%
Environmental Features	
Working Temperature	0 to +40 °C / +32° to +104 °F
Storage Temperature (without battery)	-20 to +70 °C / -4° to +158 °F
Humidity	90% non condensing
Drop resistance	IEC 68-2-32 Test ED
Protection class	IP30
Mechanical Features	
Weight (with batteries)	about 280 g. / 9.87 oz
Dimensions	179 x 81 x 98 mm / 7.04 x 3.18 x 3.85 in
Material	ABS and Polycarbonate molded with rubber

* It is possible to employ also NiCd or non-chargeable Alkaline AA batteries.

6.3 OM-GRYPHON™ / C-GRYPHON™

	OM-Gryphon™	C-Gryphon™
Electrical and General Features		
Supply Voltage	9 to 28 Vdc	
Power Consumption (max)	8 W (charging) *	
Indicators	Battery Charging LED (red) Charge completed LED (green) Power/Data LED (yellow)	
Recharge Time NiMh / NiCd batteries	From 3 to 5 hours	
Host Interfaces		
RS232	150 to 38400 baud	9600 baud
WEDGE	IBM AT or PS/2, XT, PC Notebook, IBM SURE1, IBM 3153, 31xx, 32xx, 34xx, 37xx terminals, Wyse terminals, Digital VT terminals, Apple ADB Bus supported	Not supported
PEN Emulation	Selectable minimum pulse from 200 µS to 1.2 mS	
Environmental Features		
Working Temperature	0° to +40 °C / +32° to +104 °F	
Storage Temperature	-20° to +70 °C / -4° to +158 °F	
Humidity	90% non condensing	
Protection	IP30	
Mechanical Features		
Weight (without cable)	about 250 g. / 8.81 oz.	
Dimensions	208 x 107 x 55.5 mm / 8.1 x 4.2 x 2.18 in	
Material	ABS	

* Having a switching regulator inside, the OM-Gryphon™ and C-Gryphon™ draw the same power, regardless of the supply voltage. i.e. as the input voltage increases the current drawn decreases.

6.4 SYSTEM AND RADIO FEATURES

Radio Features	European Models	USA Models
Working Frequency	433.92 MHz	910 MHz
Bit Rate	19200	36800
Effective Radiated Power	<10 mW	<1 mW
Range (in open air)	30 m	15 m
RF Modulation	FSK	
System Configurations	OM-GRYPHON™	STARGATE™
Maximum number of devices per base stations	16	255
Maximum number of devices in the same reading area	2000	
Maximum number of base stations in network		16

6.5 STATUS INDICATORS

The reader has three indicators, LED, Beeper and Good Read Spot. The OM-Gryphon™ and C-Gryphon™ cradles have three indicator LEDs. They signal several operating conditions which are described in the tables below.

H = high tone

L = low tone

GRYPHON™ D/M READER START-UP

Beeper¹	Meaning
L L L L	Parameters loaded correctly
H H H H long tones	Parameter loading error, reading or writing error in the non volatile memory
H L H L	Hardware error in EEPROM

GRYPHON™ D/M READER CONFIGURATION

Beeper¹	Meaning
H H H H	Correct entry or exit from Configuration mode
L	Good read of a command
L L L	Command read error

GRYPHON™ D/M READER DATA ENTRY

Beeper ¹	LED	Good Read Spot	Meaning
one beep ²	ON	ON	Correct read of a code in normal mode
H L long			TX buffer full (when FIFO is enabled) or TX error between Gryphon™ M and OM-Gryphon™
H long	ON	ON	Successful advanced format concatenation
H H H			Timeout expired – operation not completed
H H long			Error in advanced data formatting
	OFF	OFF	Ready to read a code

GRYPHON™ M POWER

Beeper	LED	Meaning
10 short H	10 short blinks	Low Battery

GRYPHON™ M BIND, JOIN, COPY COMMANDS

Beeper ¹	LED	Meaning
	Blinking	Command accepted; reader ready to be inserted into the cradle
L		Success
H L long tones		Failure

¹ Only the Beeper Intensity command can modify these signals.

² The data entry good read tone is user-configurable with all the Beeper commands in the Reading Parameters section.

For M-Series readers, normally this results in two beeps; the first indicates that the reader has decoded the code, the second indicates whether OM-Gryphon™ has received the data. See also par. 5.8.3.

OM-GRYPHON™/C-GRYPHON™ CHARGE STATUS

Red LED	Green LED	Meaning
ON	ON	Charging
OFF	ON	End of charge
OFF	OFF	No battery inserted
Flashing	OFF	Discharging (see par. 2.8.2)
Flashing	Flashing	Shorted or open battery

OM-GRYPHON™/C-GRYPHON™ POWER/COMMUNICATION

Yellow LED	Meaning
ON	Power applied
OFF	Error in reading EEPROM parameters
Blinking	Transmission over the Host port

6.6 READING DIAGRAMS

GRYPHON™ D/M100

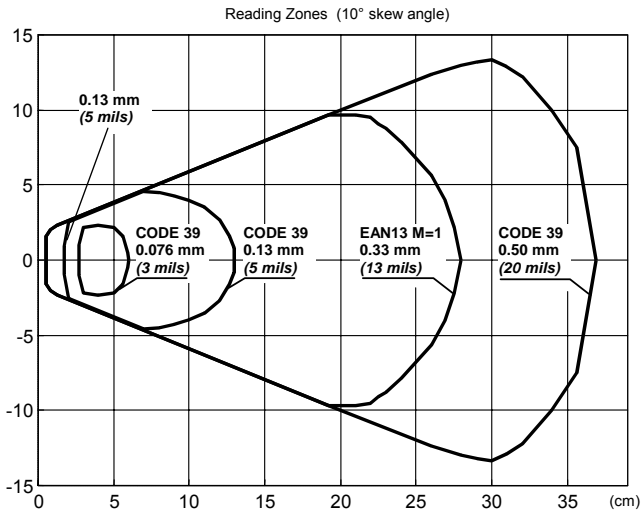

GRYPHON™ D/M200

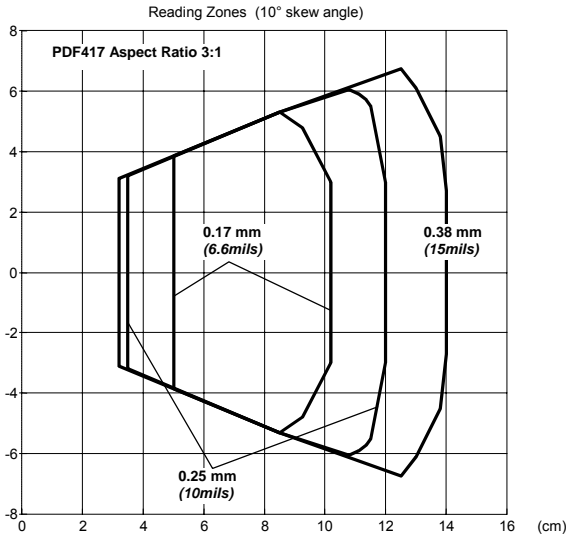
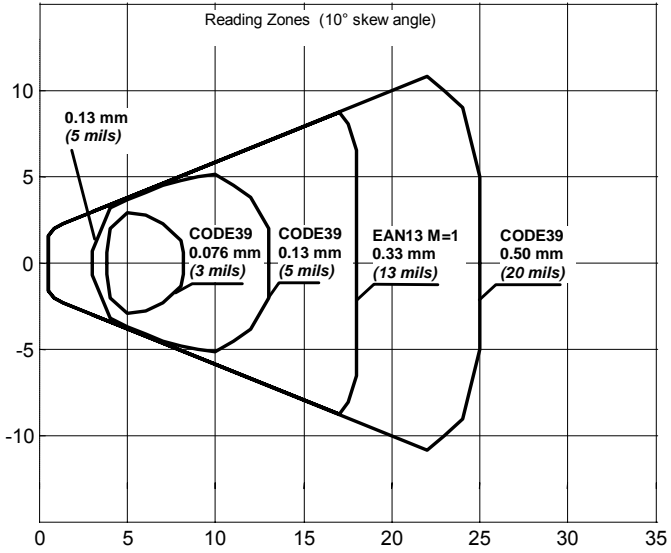

A HOST CONFIGURATION STRINGS

In this section we provide a description of how to modify the device configuration using serial strings sent from the Host.

This method requires the RS232 interface.

The device configuration can be changed by receiving commands from the Host through the serial interface. When this method is used, the programming sequence format is the following:

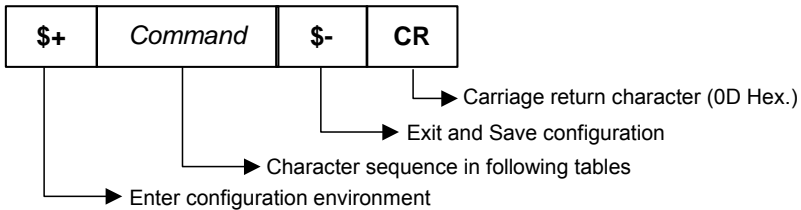

Example:

Multiple command programming sequence:

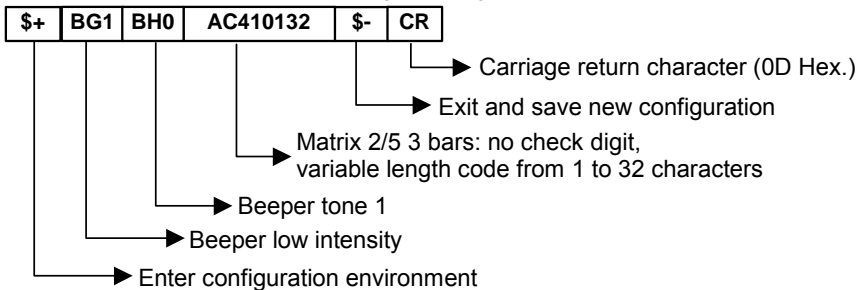

Each configuration parameter setting removes the condition previously active for that parameter.



NOTE

The device buffer can contain about 400 characters. If your programming string goes over this value, you must split it into separate groups and send each group after a delay of at least 3 seconds to give the reader time to empty the buffer and interpret the commands.

SERIAL CONFIGURATION STRINGS

ENTER/EXIT CONFIGURATION COMMANDS	
DESCRIPTION	STRING
Enter Configuration	\$+
Exit and Save Configuration	\$-
Restore Default	\$*
Transmit Software Release (not for PEN emulation)	\$!
Transmit Device Configuration in ASCII (not for PEN emulation)	\$&

These commands do not require \$-.

INTERFACE SELECTION			
DESCRIPTION	STRING		
RS232	Standard	CP0	
	ICL Mode	CM0	
	Fujitsu	CM1	
	Nixdorf Mode A	CM2ECO	
WEDGE	for IBM AT	CP500	
	for IBM Terminals: 31xx, 32xx, 34xx, 37xx; make-break keyboard	CP501	
	for IBM Terminals: 31xx, 32xx, 34xx, 37xx; make-only keyboard	CP502	
	Keyboard Type for IBM Terminals 31xx, 32xx, 34xx, 37xx	typewriter	FK0
		advanced	FK1
	for IBM XT	CP503	
	for IBM Terminal 3153	CP504	
	for IBM PC Notebook	CP505	
	for IBM SURE1	CP506	
	for IBM AT - ALT mode	CP507	
	for IBM PC Notebook - ALT mode	CP508	
	for Wyse Terminal - ANSI Keyboard	CP509	
	for Wyse Terminal - PC Keyboard	CP510	
	for Wyse Terminal - ASCII Keyboard	CP511	
	for Wyse Terminal - VT220 style Keyboard	CP514	
for Digital Terminals VT2xx/3xx/4xx	CP512		
for Apple ADB Bus	CP513		
PEN EMULATION	CP6		
IBM 46xx	4501 Protocol	CP800	
	1520 Protocol	CP801	
USB	USB-KBD	UA03	
	USB-KBD-ALT-MODE	UA04	
	USB-KBD-APPLE	UA05	
	USB-COM	UA02	
	USB-IBM-Table Top	UA00	
	USB-IBM-Hand Held	UA01	

RS232		
DESCRIPTION		STRING
Baud rate	150	CD0
	300	CD1
	600	CD2
	1200	CD3
	2400	CD4
	4800	CD5
	9600	CD6
	19200	CD7
	38400	CD8
Parity	none	CC0
	even	CC1
	odd	CC2
Data bits	7	CA0
	8	CA1
	9	CA2
Stop bits	1	CB0
	2	CB1
Handshaking	disable	CE0
	RTS/CTS	CE1
	XON/XOFF	CE2
	RTS always On	CE3
ACK/NACK Protocol	disable (sw 3.1.0)	CF0
	enable (sw 3.1.0)	CF3
	disable (sw 4.0 and later)	ER0
	enable (sw 4.0 and later)	ER1
FIFO	disable	EC0
	enable	EC1
Inter-character delay (ms)		CK00 - CK99
RX Timeout (100 ms)		CL00 - CL99
Serial Trigger Lock	disable	CR0
	enable and select characters	CR1ab

a = Hex values representing an ASCII character from **00** to **FE** enabling the device trigger.

b = HEX values representing an ASCII character from **00** to **FE** inhibiting the device trigger.

USB		
DESCRIPTION		STRING
USB-COM		
Handshaking	disable	CE0
	RTS/CTS	CE1
	XON/XOFF	CE2
	RTS always ON	CE3
ACK/NACK Protocol	disable	ER0
	enable	ER1
FIFO	disable	EC0
	enable	EC1
Inter-character delay (<i>ms</i>)		CK00 - CK99
RX Timeout (<i>100 ms</i>)		CL00 - CL99
Serial Trigger Lock	disable	CR0
	enable	CR1^ab
USB-KBD		
Keyboard nationality (not for USB-KBD-ALT-MODE)	Belgian	FJ7
	English	FJ4
	French	FJ2
	German	FJ3
	Italian	FJ1
	Spanish	FJ6
	Swedish	FJ5
	USA	FJ0
	Japanese	FJ8
FIFO	disable	EC0
	enable	EC1
Delays	Inter-Character (<i>ms</i>)	CK00 - CK99
	Inter-Code (<i>s</i>)	FG00 - FG99

a = Hex values representing an ASCII character from **00** to **FE** enabling the device trigger.

b = HEX values representing an ASCII character from **00** to **FE** inhibiting the device trigger.

WEDGE		
DESCRIPTION		STRING
Keyboard nationality	Belgian	FJ7
	English	FJ4
	French	FJ2
	German	FJ3
	Italian	FJ1
	Spanish	FJ6
	Swedish	FJ5
	USA	FJ0
	Japanese (IBM AT compatible only)	FJ8

WEDGE (continued)		
DESCRIPTION		STRING
Caps Lock	caps Lock ON	FE1
	caps Lock OFF	FE0
Caps Lock Auto-Recognition (IBM AT compatible only)	disable	FP0
	enable	FP1
Num Lock	Toggle Num Lock	FL1
	Num Lock Unchanged	FL0
Delays	Inter-Character (<i>ms</i>)	CK00 - CK99
	Inter-Code (<i>s</i>)	FG00 - FG99

PEN		
DESCRIPTION		STRING
Operating mode	interpret (does not require \$+ or \$-)	\$]
	transparent (does not require \$+ or \$-)	\$[
Minimum output pulse	200µs	DG0
	400µs	DG1
	600µs	DG2
	800µs	DG3
	1 ms	DG4
	1.2 ms	DG5
Conversion to Code 39 and Code 128	disable conversion to Code 39 (D series only)	DA0
	enable conversion to Code 39	DA1
	enable conversion to Code 128 (M series only)	DA2
Output level	normal	DD0
	inverted	DD1
Idle level	normal	DE0
	inverted	DE1
Overflow	narrow overflow	DH0
	medium overflow	DH1
	wide overflow	DH2
Inter-Block delay (<i>100 ms</i>)		CK00-CK99

IBM 46xx		
DESCRIPTION		STRING
IBM Data Formatting	Code 39 Format	GD0
	IBM Standard Format	GD1
	Mixed IBM Standard + Code 39 Format	GD2

DATA FORMAT		
<i>NOT FOR PEN EMULATION INTERFACES</i>		
DESCRIPTION		STRING
Code Identifier	disable	EB0
	Datalogic standard	EB1
	AIM standard	EB2
	Custom	EB3
Custom Code Identifier		EHabc
Headers	no header	EA00
	one character	EA01x
	two characters	EA02xx
	three characters	EA03xxx
	four characters	EA04xxxx
	five characters	EA05xxxxx
	six characters	EA06xxxxxx
	seven characters	EA07xxxxxxxx
eight characters	EA08xxxxxxxxx	
Terminators	no terminator	EA10
	one character	EA11x
	two characters	EA12xx
	three characters	EA13xxx
	four characters	EA14xxxx
	five characters	EA15xxxxx
	six characters	EA16xxxxxx
	seven characters	EA17xxxxxxxx
eight characters	EA18xxxxxxxxx	

a = ASCII character.

b, c, x = HEX values representing an ASCII character.

a = ASCII character of the DATALOGIC STANDARD Code Identifier from the table on page 59.

b = Hex value of the first Custom Code Identifier character from **00** to **FD**;
FF = disable Code Identifier

c = Hex value of the second Custom Code Identifier character from **00** to **FD**;
FF = disable second character of Custom Code Identifier

x = Hex value from **00** to **FE**

DATA FORMAT (continued)		
NOT FOR PEN EMULATION INTERFACES		
DESCRIPTION		STRING
Code Length Tx	not transmitted	EE0
	transmitted in variable-digit format	EE1
	transmitted in fixed 4-digit format	EE2
Field Adjustment	disable	EF0
	right addition	EFa0d
	left addition	EFa1d
	right deletion	EFa2d
	left deletion	EFa3d
Field Adjustment Character		EGe
Character Replacement	disable character replacement	EO0
	first character replacement	EO1afg
	second character replacement	EO2afg
	third character replacement	EO3afg
Address Stamping	disable reader address stamping	RU0
	enable reader address stamping	RU1
Address Delimiter	disable reader address delimiter	RV0
	enable reader address delimiter and select character	RV1h

a = ASCII character.

d = a number from the Hex/Numeric Table

e, f, g, h = HEX values representing an ASCII character

a = ASCII character of the DATALOGIC STANDARD Code Identifier from the table on page 59.

d = a number in the range **01-32** from the Hex/Numeric Table

e = Hex value from **00** to **FE**

f = Hex value of the character to be replaced from **00** to **FE**

g = Hex value of the new character to insert from **00** to **FE**

FF = replace with no new character (remove character)

h = a HEX value in the range from **00** - **FE** representing the ASCII character.

POWER SAVE		
DESCRIPTION		STRING
Scan Rate	67 scans per sec.	BT0
	135 scans per sec.	BT1
	270 scans per sec.	BT2
Sleep State/USB Suspend	disable	BQ0
	enable	BQ1
Enter Sleep Timeout (100 ms)		BR00-BR99
Standby	enable	BM0
	disable	BM1

READING PARAMETERS		
DESCRIPTION		STRING
Operating Mode	hand-held operation	BP0
	stand operation	BP1
	automatic	BP2
Hand-Held Operation	software trigger	BK0
	hardware trigger	BK1
	automatic	BK2
	always on	BK3
	hardware trigger ready	BK4
Stand Operation	software trigger	BU1
	hardware trigger	BU3
	automatic	BU0
	always on	BU2
Hardware Trigger Mode	trigger active level	BA0
	trigger active pulse	BA1
Trigger-off Timeout (s)		BD00 - BD99
FLASH ON (100 ms)		BB001 - BB099
FLASH OFF (100 ms)		BB101 - BB199
Reads per Cycle	one read	BC0
	multiple reads	BC1
Safety Time (100 ms)		BE00 - BE99
Beeper Intensity	very low intensity	BG0
	low intensity	BG1
	medium intensity	BG2
	high intensity	BG3
Beeper Tone	tone 1	BH0
	tone 2	BH1
	tone 3	BH2
	tone 4	BH3
Beeper Type	monotone	BJ0
	bitonal	BJ1
Beeper Length	long	BI0
	short	BI1
PDF Decoding Recognition Intensity	low	BW0
	high	BW1
Good Read Spot - Duration	disabled	BV0
	short	BV1
	medium	BV2
	long	BV3

DECODING PARAMETERS		
DESCRIPTION		STRING
Ink-spread	disable	AX0
	enable	AX1
Overflow control	disable	AW1
	enable	AW0
Interdigit control	disable	AV0
	enable	AV1
Puzzle Solver™	disable	AU0
	enable	AU1
Decoding Safety	one read	ED0
	two reads	ED1
	three reads	ED2
	four reads	ED3

CODE SELECTION			
DESCRIPTION		STRING	
DISABLE ALL FAMILY CODES		AZ0	
EAN/UPC	disable EAN/UPC family		AA0
	EAN 8/EAN 13/UPC A/UPC E	without ADD ON	AA1
		with ADD ON	AA5
		with and without ADD ON	AA8
	EAN 8/EAN 13	without ADD ON	AA3
		with ADD ON 2 ONLY	AAK
		with ADD ON 5 ONLY	AAL
		with ADD ON 2 AND 5	AA6
	UPC A/UPC E	without ADD ON	AA4
		with ADD ON 2 ONLY	AAM
		with ADD ON 5 ONLY	AAN
		with ADD ON 2 AND 5	AA7
	EAN 8 check digit transmission	disable	AAG0
		enable	AAG1
	EAN 13 check digit transmission	disable	AAH0
		enable	AAH1
	UPC A check digit transmission	disable	AAI0
		enable	AAI1
	UPC E check digit transmission	disable	AAJ0
		enable	AAJ1
	conversions	UPC E to UPC A	AAA
		UPC E to EAN 13	AAB
		UPC A to EAN 13	AAC
EAN 8 to EAN 13		AAD	

CODE SELECTION (continued)			
DESCRIPTION		STRING	
	ISBN Conversion codes	enable ISBN	AP1
		enable ISSN	AP2
		enable ISBN and ISSN	AP3
		disable ISBN and ISSN	AP0
Code 39	disable Code 39 family		AB0
	Standard	no check digit control	AB11
		check digit control and transmission	AB12
		check digit control without transmission	AB13
	Full ASCII	no check digit control	AB21
		check digit control and transmission	AB22
		check digit control without transmission	AB23
	CIP 39		AB3
Code 32		AB4	
code length		AB*xxxx	
2/5	disable Code 2/5 family		AC0
	Interleaved 2/5	no check digit control	AC11xxxx
		check digit control and transmission	AC12xxxx
		check digit control without transmission	AC13xxxx
	Normal 2/5 5 bars	no check digit control	AC21xxxx
		check digit control and transmission	AC22xxxx
		check digit control without transmission	AC23xxxx
	Industrial 2/5 (IATA)	no check digit control	AC31xxxx
		check digit control and transmission	AC32xxxx
		check digit control without transmission	AC33xxxx
	Matrix 2/5 3 bars	no check digit control	AC41xxxx
		check digit control and transmission	AC42xxxx
		check digit control without transmission	AC43xxxx
	CIP/HR		AC5

xxxx = ASCII numbers that define the code length where:

- First 2 digits = minimum acceptable code length.
- Second 2 digits = maximum acceptable code length.

The minimum code length must always be less than or equal to the maximum.

The maximum code length for all codes is 99 characters:

Examples:

0132 = variable length from 1 to 32 digits in the code.

1010 = 10 digit code length only.

CODE SELECTION (continued)			
DESCRIPTION		STRING	
Codabar	disable Codabar family		AD0
	Standard	no start/stop character equality control nor transmission	AD111
		no start/stop character equality control but transmission	AD112
		start/stop character equality control but no transmission	AD121
		start/stop character equality control and transmission	AD122
	ABC Codabar	no start/stop character equality control but transmission	AD212
	Codabar ABC forced concatenation		AD232
	code length		AD*xxxx
	start/stop character case in transmission	lower case	ADA0
upper case		ADA1	
Code 128	disable Code 128 family		AI0
	enable Code 128 - control without transmission of check digit		AI11
	enable EAN 128 - control without transmission of check digit		AI21
	Transmit GS before Code	disable	EQ0
		enable	EQ1
	ISBT 128	enable ISBT 128	AI31
	code length		AILxxxx
Code 93	disable Code 93 family		AK0
	enable Code 93 - control without transmission of check digit		AK1
MSI	disable the family		AE0
	no check		AE1
	MOD10 no tx		AE2
	MOD10 with tx		AE3
	MOD11-MOD10 no tx		AE4
	MOD11-MOD10 with tx		AE5
	MOD10-MOD10 no tx		AE6
	MOD10-MOD10 with tx		AE7

xxxx = ASCII numbers that define the code length where:

- First 2 digits = minimum acceptable code length.
- Second 2 digits = maximum acceptable code length.

The minimum code length must always be less than or equal to the maximum.

The maximum code length for all codes is 99 characters:

EXAMPLES:

0132 = variable length from 1 to 32 digits in the code.

1010 = 10 digit code length only.

CODE SELECTION (continued)		
DESCRIPTION		STRING
Plessey	disable the family	AF0
	Standard no check	AF11
	Standard check - with tx	AF12
	Standard check - no tx	AF13
	Anker no check	AF21
	Anker check - with tx	AF22
	Anker check - no tx	AF23
Telepen	disable the family	AL0
	Numeric no check	AL11
	Numeric check - with tx	AL12
	Numeric check - no tx	AL13
	Alpha no check	AL21
	Alpha check - with tx	AL22
Delta IBM	Alpha check - no tx	AL23
	disable the family	AH0
	no check	AH1
	Type 1 check	AH2
Code 11	Type 2 check	AH3
	disable the family	AG0
	no check	AG1
	Type C with tx	AG21
	Type C no tx	AG22
	Type K with tx	AG31
	Type K no tx	AG32
	Type C and K with tx	AG41
Code 16K	Type C and K no tx	AG42
	disable	AJ0
Code 49	enable	AJ1
	disable	AM0
PDF417	enable	AM1
	disable	AR0
RSS Codes	enable	AR1
	disable the family	AQ0
	disable RSS Expanded Linear and Stacked	AQ10
	enable RSS Expanded Linear and Stacked	AQ11
	disable RSS Limited	AQ20
	enable RSS Limited	AQ21
	disable RSS 14 Linear and Stacked	AQ30
	enable RSS 14 Linear and Stacked	AQ31

RADIO PARAMETERS		
DESCRIPTION		STRING
Radio Protocol Timeout	enable (seconds)	RH02-RH19
Power-Off Timeout		RP00-RP99
Beeper Control For Radio Response	normal	BF0
	only good decode	BF1
	only good reception	BF2
	off	BF3
Battery Type	alkaline	RB0
	NiMh	RB1
Single Store	disable	RO0
	one attempt	RO1
	two attempts	RO2
	three attempts	RO3
	four attempts	RO4
	five attempts	RO5
	six attempts	RO6
	seven attempts	RO7
	eight attempts	RO8
nine attempts	RO9	

B CODE IDENTIFIER TABLE

2/5 Interleaved



2/5 Industrial



2/5 normal 5 bars



2/5 matrix 3 bars



EAN 8



EAN 13



UPC A



UPC E



EAN 8 with 2 ADD ON



EAN 8 with 5 ADD ON



EAN 13 with 2 ADD ON



EAN 13 with 5 ADD ON



UPC A with 2 ADD ON



UPC A with 5 ADD ON



UPC E with 5 ADD ON



Code 39 Full ASCII



ABC CODABAR



EAN 128



CIP/39



Code 32



UPC E with 2 ADD ON



Code 39



CODABAR



Code 128



Code 93



CIP/HR



ISBT 128



MSI



Plessey Standard



Telepen



Code 11



RSS Expanded Linear and Stacked



RSS 14 Linear and Stacked



Plessey Anker



Delta IBM



Code 16K



Code 49



RSS Limited



PDF417



Australia

Datalogic Scanning Pty Ltd
North Ryde, Australia
Telephone: [61] (2) 9870 3200
Fax: [61] (2) 9878 8688

France and Benelux

Datalogic Scanning Sarl
LES ULIS Cedex, France
Telephone: [33].01.64.86.71.00
Fax: [33].01.64 46.72.44

Germany

Datalogic Scanning GmbH
Darmstadt, Germany
Telephone: 49 (0) 61 51/93 58-0
Fax: 49 (0) 61 51/93 58 58

Italy

Datalogic Scanning SpA
Vimercate (MI), Italy
Telephone: [39] (0) 39/62903.1
Fax: [39] (0) 39/6859496

Japan

Datalogic Scanning KK
Shinagawa, Tokyo, Japan
Telephone: 81 (0)3 3491 6761
Fax: 81 (0)3 3491 6656

Latin America

Datalogic Scanning, Inc
Miami, Florida, USA
Telephone: (305) 591-3222
Fax: (305) 591-3007

Spain and Portugal

Datalogic Scanning Sarl
Sucursal en España
Madrid, Spain
Telephone: 34 91 746 28 60
Fax: 34 91 742 35 33

United Kingdom

Datalogic Scanning LTD
Watford, England
Telephone: 44 (0) 1923 809500
Fax: 44 (0) 1923 809 505



www.scanning.datalogic.com

Datalogic Scanning, Inc.

959 Terry Street
Eugene, OR 97402
Telephone: (541) 683-5700
Fax: (541) 345-7140